

White paper developed for

RYSAVY
RESEARCH



Mobile Broadband

EDGE, HSPA & LTE

September 2006

Prepared by Peter Rysavy

www.rysavy.com



TABLE OF CONTENTS

INTRODUCTION	3
WIRELESS DATA MARKET	5
Trends	5
EDGE/UMTS/HSDPA Deployment	7
Statistics	8
TECHNOLOGY CAPABILITIES AND MIGRATION	9
Technical Approaches (TDMA, CDMA, OFDM)	10
3GPP Evolutionary Approach	11
GPRS and EDGE	13
EDGE Deployment	19
EDGE Evolution	20
UMTS/HSPA Technology	26
UMTS Release 99 Data Capabilities.....	28
HSDPA.....	29
High Speed Uplink Packet Access (HSUPA)	33
Evolution of HSPA (HSPA+).....	34
HSPA Voice over IP	35
3GPP Long Term Evolution (LTE).....	36
4G.....	38
UMTS TDD.....	38
TD-SCDMA	39
INFRASTRUCTURE AND SERVICE ADVANCES	40
IP Multimedia Subsystem (IMS)	40
Multimedia Broadcast/Multicast Service (MBMS).....	41
System Architecture Evolution (SAE)	41
EDGE/HSPA/LTE DEPLOYMENT AND MIGRATION	43
COMPETING TECHNOLOGIES	45
CDMA2000	46
WiMAX	48
Flash OFDM	50
IEEE 802.20.....	50
Wi-Fi	50
Market Fit.....	51
COMPARISON OF WIRELESS TECHNOLOGIES	53
Data Throughput	53
HSDPA Throughput in Representative Scenarios.....	56
Release 99 and HSUPA Uplink Performance	58
Latency	59
Spectral Efficiency	60
Power Consumption Comparison	65
Cost and Volume Comparison.....	66
Competitive Summary.....	67
CONCLUSION	68
ADDITIONAL INFORMATION	70
REFERENCES	70
ACRONYMS	74

Introduction

Universal Mobile Telecommunications System (UMTS)/High Speed Packet Access (HSPA) technology and its evolution to beyond Third Generation (3G) will compete with any and all mobile wireless technologies available today and in the future. Building on the phenomenal success of Global System for Mobile Communications (GSM), the GSM/UMTS ecosystem, unmatched by any other mobile wireless technology and possibly unmatched by any other communication technology ever, is not just a future dream. It is here now. UMTS/HSPA has many key technical and business advantages over other mobile wireless technologies. Whereas other wireless technologies show great potential on paper, UMTS today has global commercial deployments providing customers mobile broadband service.

Operators worldwide are now deploying High Speed Downlink Packet Access (HSDPA), one of the most powerful cellular-data technologies ever developed. HSDPA, which will be widely deployed in 2006, follows the successful deployment of UMTS networks around the world and, for many of these networks, is a relatively straightforward upgrade. In fact, some operators will deploy UMTS enhanced with HSDPA immediately upon their initial launch. The UMTS to HSDPA upgrade is similar to Enhanced Data Rates for GSM Evolution (EDGE), which has already proven to be a remarkably effective upgrade to GSM networks, and is now supported by a large number of operators and vendors worldwide.

High Speed Uplink Packet Access (HSUPA¹) will quickly follow HSDPA, with the combination of the two technologies being called simply High Speed Packet Access (HSPA). HSPA is strongly positioned to be the dominant mobile data technology for the rest of the decade. To leverage operator investments in HSPA, standards bodies are examining a series of enhancements to create "HSPA Evolution," also referred to as "HSPA+." HSPA Evolution represents a logical development of the Wideband Code Division Multiple Access (WCDMA) approach, providing the stepping-stone to an entirely new Third Generation Partnership Project (3GPP) radio platform called 3GPP Long Term Evolution (LTE). LTE, which uses Orthogonal Frequency Division Multiple (OFDM), should be ready for deployment in the 2009 time frame. Simultaneously, standards bodies, recognizing the significant worldwide investments in GSM networks, are now defining enhancements that will significantly increase EDGE data capabilities through an effort called Enhanced GSM/EDGE Radio Access Network (GERAN).

Combined with these improvements in radio-access technology are new approaches to infrastructure, such as IP Multimedia Subsystem (IMS) and System Architecture Evolution (SAE). These will facilitate new types of services, the integration of legacy and new networks, the convergence between fixed and wireless systems, and the transition from circuit-switched approaches for voice traffic to a fully packet-switched model.

The result is a balanced portfolio of complementary technologies that provides operators maximum flexibility in how they enhance their networks over time as well as support both voice and data services. This paper discusses the evolution of EDGE, HSPA enhancements, 3GPP Long Term Evolution, the capabilities of these technologies, and their position relative to some competing technologies.

¹ While the primary downlink traffic channel supporting HSDPA services is a **shared** channel designed for the support of services delivered through the Packet-Switched Domain, the primary uplink traffic channel defined for "HSUPA" is a **dedicated** channel that could be used for services delivered either through the Circuit-Switched or through the Packet-Switched Domains. Nevertheless, by extension and for simplicity, the WCDMA enhanced Uplink capabilities are often identified in the literature as HSUPA and hence, this term and its extension HSPA are also used in this white paper.

Following are some of the important observations and conclusions of this paper:

- ❑ GSM/UMTS has an overwhelming global position in terms of subscribers, deployment, and services. Its success will marginalize other wide-area wireless technologies.
- ❑ The 3GPP roadmap provides operators maximum flexibility in deploying and evolving their networks. The roadmap is comprised of three avenues, including the continued evolution of GSM system capabilities, UMTS evolution and 3GPP LTE. Each technology is designed to coexist harmoniously with the others.
- ❑ EDGE technology has proven extremely successful and is widely deployed on GSM networks globally. EDGE improvements will be able to more than quadruple current EDGE throughput rates.
- ❑ UMTS/HSPA represents tremendous radio innovation and capability, which allows it to support a wide range of applications, including voice and data on the same devices.
- ❑ The high spectral efficiency of HSPA for data and Wideband CDMA (WCDMA) for voice provides UMTS operators an efficient high-capacity network for all services. In the longer term, UMTS provides for a clean migration to packet-switched voice.
- ❑ In current deployments, HSDPA users under favorable conditions regularly experience throughput rates well in excess of 1 megabit per second (Mbps). These peak user-achievable throughput rates will increase with planned enhancements of HSDPA.
- ❑ HSUPA users under favorable conditions will experience peak achievable rates close to 1 Mbps in the uplink.
- ❑ Continual HSPA enhancements are planned. Beginning with enhanced uplink performance, advanced receivers in the mobile and in the base station, and then Multiple Input Multiple Output (MIMO), these improvements will extend HSPA capability even further.
- ❑ 3GPP is developing a Long Term Evolution technology path with the goal of initially deploying next-generation networks in the 2009 time frame. Expect peak downlink speeds of 100 Mbps and peak uplink speeds of 50 Mbps in 20 MHz channels. LTE uses OFDM on the downlink and Single Carrier Frequency Division Multiple Access (SC-FDMA) on the uplink.
- ❑ OFDM approaches may provide high spectral efficiency and high peak rates. However, HSPA+ systems could match OFDM-based approaches in spectral efficiency and peak data rates in 5+5 MHz radio allocations through the use of equalizers and interference cancellation techniques.
- ❑ With relative ease, operators can transition their General Packet Radio Service (GPRS) networks to EDGE and their UMTS networks to HSDPA/HSUPA and, in the future, to HSPA+ and LTE. In some cases operators can attain these improvements by upgrading the software in their platforms (i.e., no hardware change required).
- ❑ With a UMTS multi-radio network, a common core network can efficiently support GSM, WCDMA, and HSPA access networks, offering high efficiency for both high and low data rates as well as for both high and low traffic density configurations.
- ❑ Voice over Internet Protocol (VoIP) with HSPA will eventually add to voice capacity and reduce infrastructure costs. In the meantime, UMTS enjoys high circuit-switched voice spectral efficiency and can combine voice and data on the same radio channel.

- ❑ LTE assumes a full Internet Protocol (IP) network architecture and is designed to support voice in the packet domain.
- ❑ Ongoing 3GPP evolution includes significant enhancements with each new specification release. These include higher throughput rates, enhanced multimedia support, and integration with other types of wireless networks.

This paper begins with an overview of the market, looking at adoption of services and deployment of GSM-UMTS technologies. It then explains the capabilities and workings of the different technologies, including GPRS, EDGE, WCDMA², HSPA, HSPA Evolution and LTE. This discussion includes the progression of capability, deployment, and migration considerations. The paper then examines other wireless technologies, including CDMA2000 and Worldwide Interoperability for Microwave Access (WiMAX). Finally, the paper technically compares different wireless technologies with respect to performance and spectral efficiency.

Wireless Data Market

At the end of June 2006, two billion of the world's 2.41 billion cellular subscribers used GSM/UMTS. Informa's World Cellular Information Service³ projects three billion GSM/UMTS customers by 2009, with 511 million of these subscribers using UMTS services. Clearly, GSM/UMTS has established global dominance. Although voice still constitutes most cellular traffic, wireless data now exceeds 10 percent of Average Revenue Per User (ARPU), and this number could easily double within three years. Operators across the Americas are confirming this trend with their reports of rising data ARPU. For instance, for the second quarter of 2006, Cingular Wireless reported ARPU from data services rose 38 percent to \$5.77 per month. T-Mobile reported data ARPU represented 10.9% of blended ARPU in the second quarter of 2006, as compared to 10.1% in the first quarter of 2006, and 7.5% in the second quarter of 2005. Rogers Wireless of Canada reported a 65.1% lift in data revenues, representing 10.5% of the total network revenue of the quarter.

This section examines trends and deployment and then provides market data that demonstrates the rapid growth of wireless data.

Trends

Users are adopting wireless data in a wide range of applications, including e-mail, game downloads, instant messaging, ringtones, and video as well as enterprise applications such as group collaboration, enterprise resource planning, customer relationship management, and database access. This simultaneous adoption by both consumers for entertainment-related services and businesses to enhance productivity increases the return-on-investment potential for wireless operators.

A number of important factors are accelerating adoption of wireless data. These include increased user awareness, innovative feature phones, powerful smartphones, and global coverage. But two factors stand out: network capability and applications. Technologies such as GSM, WCDMA and HSPA provide the capability to support a wide range of applications, including standard networking applications as well as those designed for

² Although many use the terms "UMTS" and "WCDMA" interchangeably, in this paper we use "WCDMA" when referring to the radio interface technology used within UMTS and "UMTS" to refer to the complete system. HSDPA is an enhancement to WCDMA.

³ 3G Americas press release of June 13, 2006.

wireless. Meanwhile, application and content suppliers are optimizing their applications, or in many cases developing entirely new applications and content, to target the needs and desires of mobile users.

Computing itself is becoming ever more mobile, and notebooks, PDAs, and smartphones are now prevalent. In fact, all phones are becoming “smart” with some form of data capability. Leading notebook vendors are now offering computers with integrated 3G capabilities. Lifestyles and work styles themselves are increasingly mobile, with more people traveling for work, pleasure, or in retirement. Meanwhile, the Internet is becoming progressively more intertwined with people’s lives, providing communications, information, enhancements for memberships and subscriptions, community involvement, and commerce. In this environment, wireless access to the Internet is a powerful catalyst for the creation of new services and new business opportunities for operators as well as third-party businesses.

With data constituting a rising percentage of total cellular traffic, it is essential that operators deploy data technologies that meet customer requirements for performance and are spectrally efficient—especially as data applications can demand significantly more network resources than traditional voice services. Operators have a huge investment in spectrum and in their networks; data services must leverage these investments. It is only a matter of time before today’s more than two billion cellular customers start taking full advantage of data capabilities. This presents tremendous opportunities and risks to operators as they choose the most commercially viable evolution path for migrating their customers. The EDGE/HSPA/LTE evolution paths provide data capabilities to address market needs, delivering ever-higher data throughputs, lower latency and increased spectral efficiency.

Although wireless data has always offered a tantalizing vision of always-connected mobile computing, adoption has been slower than that for voice services. In the past several years, however, adoption has accelerated; *finally*, some might say, and thanks to a number of key developments. Networks themselves are much more capable, delivering higher throughputs at lower cost. Awareness of data capabilities has increased, especially through the pervasive success of Short Message Service (SMS), wireless e-mail, downloadable ringtones, and downloadable games. Widespread availability of services has also been important. The features found in cellular telephones are expanding at a rapid rate and today include large color displays, graphics viewers, still cameras, movie cameras, MP3 players, instant messaging clients, e-mail clients, Push-to-talk over Cellular (PoC), downloadable executable content capability, and browsers supporting multiple formats. All these capabilities consume data. Meanwhile, smartphones, which emphasize a rich computing environment on a phone, represent the convergence of: 1) the personal digital assistant; 2) a fully capable mobile computer; and 3) a phone in a device that is only slightly larger than the average cellular telephone. Many users would prefer to carry one device that “does it all.”

As a consequence, this rich network and device environment is spawning the availability of a wide range of wireless applications and content. Why? Application and content developers simply cannot afford to ignore this market because of its growing size—and its unassailable potential. And they aren’t. Consumer content developers are already successful, providing downloadable ringtones and games. Enabled by 3G network capability, downloadable and streaming music and video are not far behind. In the enterprise space, all the major developers now offer mobilized “wireless-friendly” components for their applications. Acting as catalysts, a wide array of middleware providers address issues such as increased security (e.g., Virtual Private Networks [VPNs]), switching between different networks (e.g., Wireless Local Area Networks

[WLANs] to 3G), session maintenance under adverse radio conditions, and policy mechanisms that control application access to networks.

This market data is encouraging. But realistically, the market is still in relative infancy. Though consumer awareness of services is higher than ever before, many people still do not understand the true range of data options available to them. For example, only recently have operators started encouraging smartphone subscribers to use their phones as modems for their laptops. However, a number of powerful catalysts will spur wireless data innovation. Pricing for unlimited⁴ usage plans has declined by as much as a third, encouraging greater numbers of users to adopt data services. Operators are seeing considerable success with sales of music. New capabilities such as video sharing will soon be enabled by IMS, which will also facilitate fixed/mobile convergence and seamless communications experiences that span cellular and Wireless Fidelity (Wi-Fi) networks. Location-based services, mobile commerce, and other application enablers will help fuel growth too.

In the enterprise space, the first stage of wireless data was essentially to replace modem connectivity. The next is to offer existing applications on new platforms like smartphones. But the final, and much more important, change is where jobs are reengineered to take full advantage of continuous connectivity. All this takes time, but the momentum—in the direction of increased efficiency, increased convenience, and increased entertainment, all fueled by wireless data—is unstoppable.

The key for operators is enhancing their networks to support the demands of consumer and business applications as they grow, along with complementary capabilities such as IP-based multimedia. This is where the GSM family of data technologies is particularly compelling. Not only does it provide a platform for continual improvements in capabilities, but it does so over huge coverage areas and on a global basis.

EDGE/UMTS/HSDPA Deployment

Nearly every GSM network in the world today supports GSM data service (GPRS), making it the most broadly available IP-based wireless data service ever deployed. The GSM EDGE feature is another success story. As of September 2006, more than 239 operators in 121 countries around the world were using EDGE in their GSM networks. This includes 160 operators offering commercial service in 91 countries and 74 operators in various stages of deployment.⁵

EDGE has reached critical mass in terms of coverage of population, geography, infrastructure, and devices. Today, GSM operators with EDGE have over half a billion potential customers within their networks. Because of the very low incremental cost of including EDGE capability in GSM network deployment, virtually all new GSM infrastructure deployments are also EDGE capable and nearly all new mid- to high-level GSM devices include EDGE radio technology.

Meanwhile, UMTS has established itself globally. Nearly all WCDMA handsets are also GSM handsets so WCDMA users can access the wide base of GSM networks and services. There are now nearly 75 million UMTS customers worldwide across 135 commercial networks. Fifty-one operators in 33 countries are offering HSDPA services, and an

⁴ Typically, some restrictions apply.

⁵ Information compiled by 3G Americas from Informa Telecoms & Media, World Cellular Information Service and public company announcements, September 2006.

additional 54 operators have committed to the technology.⁶ It is likely that most UMTS operators will deploy HSDPA for two main reasons: One, the incremental cost of HSDPA is relatively low; and two, HSDPA makes such efficient use of spectrum for data that it results in a much lower overall cost per megabyte of data delivered.

Statistics

The U.S. wireless data market is growing at an impressive rate. A Cellular Telecommunications & Internet Association (CTIA) survey⁷ indicates that US revenues from wireless data services increased 86 percent in the past year, resulting in \$8.58 billion in revenue in 2005. According to technology and strategy consulting firm Chetan Sharma⁸, the top four U.S. carriers had over \$6.3 billion in wireless data revenues during the first half of 2006, and wireless data service revenues for 2006 are likely to grow 75 percent over 2005 figures. SMS and data transport still drive the bulk of data revenues, but their percentage share is declining.

This is consistent with wireless data's global growth. Last year's global revenues from mobile data services exceeded \$100 billion, and data revenue growth remained strong into 2006 with Q1 growth of 17 percent from a year ago, according to Informa Telecoms and Media⁹. Based on current growth trends, the Yankee Group anticipates that by 2010, wireless data share of total ARPU will be 22.6%, translating to actual global industry revenue of \$166 billion¹⁰.

Wireless data is a huge market, one where success will be driven by the efficiencies and capabilities of the underlying technologies. Informa Senior Research Analyst Kester Mann confirmed, "Data revenues continue to be driven by the ongoing deployment of advanced technologies, improvements in handsets, and global subscription growth."

From a device perspective, The Shosteck Group¹¹ projects the following sales of WCDMA handsets, including WCDMA/EDGE handsets:

- 2004: 22 million
- 2005: 50 million
- 2006: 112 million
- 2007: 225 million
- 2008: 310 million

Analyst firm Gartner predicts that sales of HSDPA handsets will reach 2.1 million this year and will increase to 89.3 million by 2009.¹²

⁶ "World Cellular Information Service," Informa Telecoms & Media, September 2006.

⁷ "Mobile Broadband: The Global Evolution of UMTS/HSPA—3GPP Release 7 and Beyond," 3G Americas white paper, July 2006.

⁸ "U.S. Wireless Data Market—Mid Year Update 2006," Chetan Sharma, <http://www.chetansharma.com/midyearupdate06.htm>

⁹ Informa Telecom & Media's World Cellular Information Service, July 2006.

¹⁰ "Global Wireless/Mobile Premium Forecast," Yankee Group report, November 2005, © Copyright 1997-2006. Yankee Group Research Inc. All rights reserved.

¹¹ The Shosteck Group, July 2006.

¹² "Forecast: Mobile Terminals, Worldwide, 2000-2009 (4Q05 Update)," Gartner, January 12, 2006.

It is clear that both EDGE and UMTS/HSDPA are dominant wireless technologies. And powerful data capabilities and global presence mean these technologies will likely continue to capture most of the available wireless data market.

Technology Capabilities and Migration

The EDGE/HSPA/LTE family of data technologies provides ever-increasing capabilities that support ever more demanding applications. GPRS and EDGE, now available globally, already make a wealth of applications feasible, including enterprise applications, messaging, e-mail, Web browsing, consumer applications, and even some multimedia applications. With UMTS and HSDPA, users are enjoying videophones, high-fidelity music, richer multimedia applications, and efficient access to their enterprise applications.

It is important to understand the needs enterprises and consumers have for these services. The obvious needs are broad coverage and high data throughput. Less obvious needs for users, but as critical for effective application performance, are low latency, quality of service (QoS) control, and spectral efficiency. Spectral efficiency, in particular, is of paramount concern, as it translates to higher average throughputs (and thus more responsive applications) for more users active in a coverage area. The discussion below, which examines each technology individually, details how the progression from GPRS to HSPA then LTE is one of increased throughput, enhanced security, reduced latency, improved QoS, and increased spectral efficiency.

It is also helpful to specifically note the throughput requirements necessary for different applications:

- ❑ Microbrowsing (e.g., Wireless Application Protocol [WAP]): 8 to 32 kilobits per second (kbps)
- ❑ Multimedia messaging: 8 to 64 kbps
- ❑ Video telephony: 64 to 384 kbps
- ❑ General purpose Web browsing: 32 kbps to more than 1 Mbps
- ❑ Enterprise applications, including e-mail, database access, and VPNs: 32 kbps to more than 1 Mbps
- ❑ Video and audio streaming: 32 to 384 kbps

Note that GPRS and EDGE already satisfy the demands of many applications. With HSPA, applications operate faster and the range of supported applications expands even further.

Under favorable conditions, EDGE delivers peak user-achievable throughput rates close to 200 kbps and initial deployments of HSDPA deliver peak user-achievable downlink throughput rates of well over 1 Mbps, easily meeting the demands of many applications. Latency has kept improving as well, with HSDPA networks today having round-trip times as low as 70 milliseconds (msec). The combination of low latency and high throughput translates to a broadband experience for users, where applications are extremely responsive. (The final section of this paper quantifies the performance of the various wireless technologies in considerable detail.)

In this section, we consider different technical approaches for wireless as well as the parallel evolution of 3GPP technologies and then provide details on GPRS/EDGE, UMTS/HSPA, LTE, and supporting technologies such as IMS.

Technical Approaches (TDMA, CDMA, OFDM)

Considerable discussion in the industry has focused on the relative benefits of Time Division Multiple Access (TDMA), Code Division Multiple Access (CDMA), and more recently Orthogonal Frequency Division Multiplexing (OFDM.) Many times, one technology or the other is positioned as having fundamental advantages over another. However, any of these three approaches, when fully optimized, can effectively match the capabilities of any other. GSM is a case in point. Through innovations such as frequency hopping, the Adaptive Multi Rate (AMR) vocoder for voice, and EDGE for optimization of data performance, GSM is able to effectively compete with the capacity and data throughput of CDMA2000 One Carrier Radio Transmission Technology (1xRTT).

Despite the evolution of TDMA capabilities, the cellular industry has generally adopted CDMA for 3G networking technology. Although there are some significant differences between CDMA2000 and WCDMA/HSDPA, such as channel bandwidths and chip rates, both technologies use many of the same techniques to achieve roughly the same degree of spectral efficiency and expected typical performance. Techniques include efficient schedulers, higher order modulation, Turbo codes, and adaptive modulation and coding.

Today, people are asking whether OFDM provides any inherent advantage over TDMA or CDMA. For systems employing less than 10 MHz of bandwidth, the answer is largely *no*. The fundamental advantage of OFDM is that because it transmits mutually orthogonal subchannels at a lower symbol rate, it elegantly addresses the problem of intersymbol interference induced by multipath and greatly simplifies channel equalization. As such, OFDM systems—assuming they employ all the other standard techniques for maximizing spectral efficiency—may achieve slightly higher spectral efficiency than CDMA systems. However, advanced receiver architectures, including items such as practical equalization approaches and interference cancellation techniques, are already commercially available in chip sets and can match this performance advantage.

It is with larger bandwidths of 10 to 20 MHz, and in combination with advanced antenna approaches such as MIMO or Adaptive Antenna Systems (AAS), where OFDM enables less computationally complex implementations than those based on CDMA. Hence, OFDM is more readily realizable in devices. However, studies have shown that the complexity advantage of OFDM may be quite small (i.e., less than a factor of two) if frequency domain equalizers are used for CDMA-based technologies. Still, the advantage of reducing complexity is one reason 3GPP chose OFDM for its LTE project. It is also one reason newer WLAN standards that employ 20 MHz radio channels are based on OFDM. In other words, OFDM is currently a favored approach under consideration for radio systems that have extremely high peak rates. OFDM also has an advantage in that it can scale easily for different amounts of available bandwidth, which allows it to be progressively deployed in available spectrum by using different numbers of subcarriers. In recent years, the ability of OFDM to cope with multipath has also made it the technology of choice for the design of Digital Broadcast Systems.

The following table summarizes the attributes of the different wireless approaches.

Table 1: Summary of Different Wireless Approaches

Approach	Technologies Employing Approach	Comments
TDMA	GSM, GPRS, EDGE, TIA/EIA-136 TDMA	First digital cellular approach. Hugely successful with GSM.

Approach	Technologies Employing Approach	Comments
		New enhancements being designed for GSM/EDGE.
CDMA	CDMA2000 1xRTT, CDMA2000 Evolved, Data Optimized (EV-DO), WCDMA, HSPA, IEEE 802.11b	Basis for nearly all new 3G networks. Mature, efficient, and will dominate wide-area wireless systems for the remainder of this decade.
OFDM	WiMAX, Flarion Fast Low-Latency Access with Seamless Handoff OFDM (Flash OFDM), 3GPP LTE, IEEE 802.11a, IEEE 802.11g, 3GPP2 Evolution, Third Generation Partnership Project 2 (3GPP2) Enhanced Broadcast Multicast Services (EBCMCS), Digital Video Broadcasting-H (DVB-H), Forward Link Only (FLO)	Effective approach for broadcast systems, higher bandwidth radio systems and high peak data rates in large blocks of spectrum. Also provides flexibility in the amount of spectrum used. Well suited for systems planned for the next decade.

3GPP Evolutionary Approach

Rather than emphasizing any one wireless approach, the 3GPP evolutionary approach is to recognize the strengths and weaknesses of each approach and to exploit the unique capabilities of each technology accordingly. GSM, based on a TDMA approach, is extremely mature and broadly deployed. Already extremely efficient, there are nevertheless opportunities for additional optimizations and enhancements, and standards bodies are working on "Evolved EDGE," which will be available in the 2008 time frame and bring more than a doubling of performance over current EDGE systems. By the end of the decade, because of sheer market momentum, the majority of worldwide subscribers will still likely be using GSM/EDGE technologies.

Meanwhile, CDMA was chosen as the basis of 3G technologies, including WCDMA for the frequency division duplex (FDD) mode of UMTS, Time Division CDMA (TD-CDMA) for the time division duplex (TDD) mode of UMTS, CDMA2000, and Time Division Synchronous CDMA (TD-SCDMA) planned for deployments in China. The evolved data systems for UMTS, such as HSPA and HSPA+, introduce enhancements and simplifications that help CDMA based systems match the capabilities of competing systems, especially in 5 MHz spectrum allocations. Over the remainder of this decade, GSM and UMTS will constitute a growing proportion of subscriptions and by decade's end will likely account for most new subscriptions.

Given some of the advantages of an OFDM approach, 3GPP has specified OFDM as the basis of its Long Term Evolution effort. LTE incorporates best-of-breed radio techniques to achieve performance levels beyond what will be practical with CDMA approaches, particularly in larger channel bandwidths. However, in the same way that 3G coexists with Second Generation (2G) systems in integrated networks, LTE systems will coexist with 3G systems as well as 2G systems. Multimode devices will function across LTE/3G or even LTE/3G/2G, depending on market circumstances.

Figure 1 shows the evolution of the different wireless technologies and their peak network performance capabilities.

Figure 1: Evolution of TDMA, CDMA, and OFDM Systems

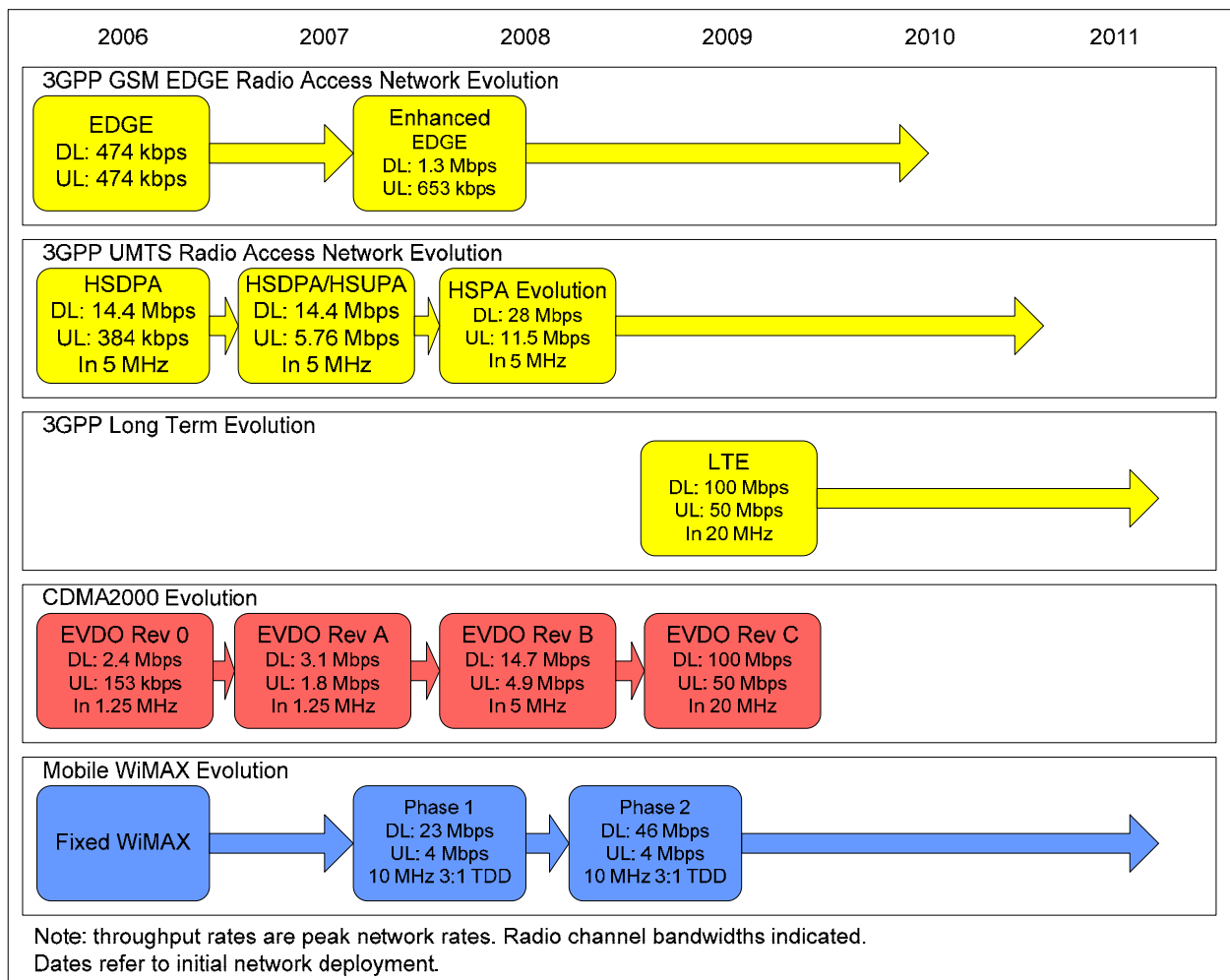

The development of GSM and UMTS/HSPA happens in stages, referred to as 3GPP releases. Equipment vendors produce hardware that supports particular specification versions. It is important to realize that the releases address multiple technologies. For example, Release 7 optimizes VoIP for HSPA but also significantly enhances GSM data functionality. A summary of the different 3GPP Releases follows:

- ❑ **Release 99:** Completed. First deployable version of UMTS. Enhancements to GSM data (EDGE). Majority of deployments today are based on Release 99. Provides support for GSM/EDGE/GPRS/WCDMA radio-access networks.
- ❑ **Release 4¹³:** Completed. Multimedia messaging support. Efficient interconnection of core network infrastructure over IP network backbones.
- ❑ **Release 5:** Completed. HSDPA and first phase of IMS. Over a third of UMTS networks now include HSDPA.

¹³ After Release 99, release versions went to a numerical designation instead of designation by year.

- ❑ **Release 6:** Completed. Includes HSUPA, enhanced multimedia support through Multimedia Broadcast/Multicast Services (MBMS), performance specifications for advanced receivers, WLAN integration option, and the second phase of IMS.
- ❑ **Release 7:** Under development. Provides enhanced GSM data functionality. Also includes fine-tuning and incremental improvements of features from previous releases. The result will be performance enhancements, improved spectral efficiency, increased capacity, and better resistance to interference. Provides VoIP over HSPA optimizations.

LTE does not yet fall into an official 3GPP release, but it is likely to be part of Release 8. Meanwhile, many aspects of HSPA+ are being specified in Release 7. The following sections discuss all the individual technologies in greater detail.

GPRS and EDGE

GPRS provides the fundamental data service for GSM, while EDGE enhances GPRS data capability through methods such as higher order modulation. Together, they constitute the world's most ubiquitous wireless data service, available now with practically every GSM network. GPRS and EDGE provide a packet-based IP connectivity solution supporting a wide range of enterprise and consumer applications. GSM networks with GPRS/EDGE operate as wireless extensions to the Internet and give users Internet access as well as access to their organizations from anywhere. With peak user-achievable¹⁴ throughput rates of up to 40 kbps with GPRS and up to 200 kbps with EDGE using four time-slot devices, users have the same effective access speed as a modem but with the convenience connecting from anywhere.

To understand the evolution of data capability, we briefly examine how these data services operate, beginning with the architecture of GPRS/EDGE, as depicted in Figure 2.

Figure 2: GSM/GPRS/EDGE Architecture

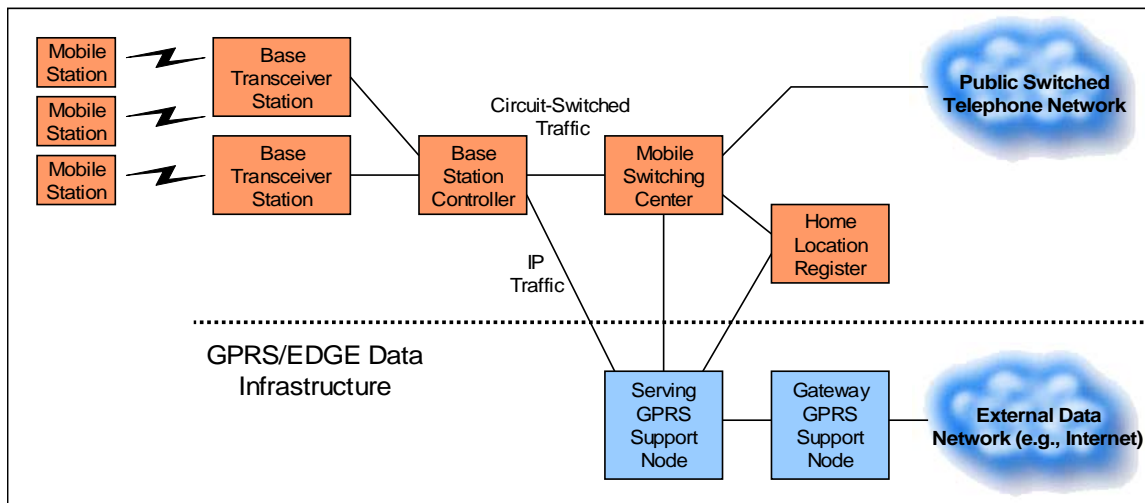

¹⁴ "Peak user-achievable" means users, under favorable conditions of network loading and signal propagation, can achieve this rate as measured by applications such as file transfer. Average rates depend on many factors and will be lower than these rates.

GPRS/EDGE is essentially the addition of a packet-data infrastructure to GSM. In fact, this same data architecture is preserved in UMTS and HSPA networks. The functions of the data elements are as follows:

1. The base station controller directs/receives packet data to/from the Serving GPRS Support Node (SGSN), an element that authenticates and tracks the location of mobile stations.
2. The SGSN performs the types of functions for data that the mobile switching center performs for voice. Each serving area has one SGSN, and it is often collocated with the Mobile Switching Center (MSC).
3. The SGSN forwards/receives user data to/from the Gateway GPRS Support Node (GGSN), which can be viewed as a mobile IP router to external IP networks. Typically, there is one GGSN per external network (e.g., the Internet). The GGSN also manages IP addresses, dynamically assigning them to mobile stations for their data sessions.

Another important element is the Home Location Register (HLR), which stores users' account information for both voice and data services. What is significant is that this same data architecture supports data services in GSM and in UMTS/HSPA networks, simplifying operator network upgrades.

In the radio link, GSM use radio channels of 200 kHz width, divided in time into eight timeslots comprising 577 μ s that repeat every 4.6 msec, as shown in Figure 3. The network can have multiple radio channels (referred to as transceivers) operating in each cell sector. The network assigns different functions to each timeslot, such as the broadcast control channel, circuit-switched functions like voice calls or circuit-switched data calls, the packet broadcast control channel (optional), and packet data channels. The network can dynamically adjust capacity between voice and data functions, and it can also reserve minimum resources for each service. This enables more data traffic when voice traffic is low or, likewise, more voice traffic when data traffic is low, which maximizes overall use of the network. For example, the Packet Broadcast Control Channel (PBCCH), which expands the capabilities of the normal Broadcast Control Channel (BCCH) may be set up on a timeslot of a TDMA frame when justified by the volume of data traffic.

Figure 3: Example of GSM/GPRS/EDGE Timeslot Structure

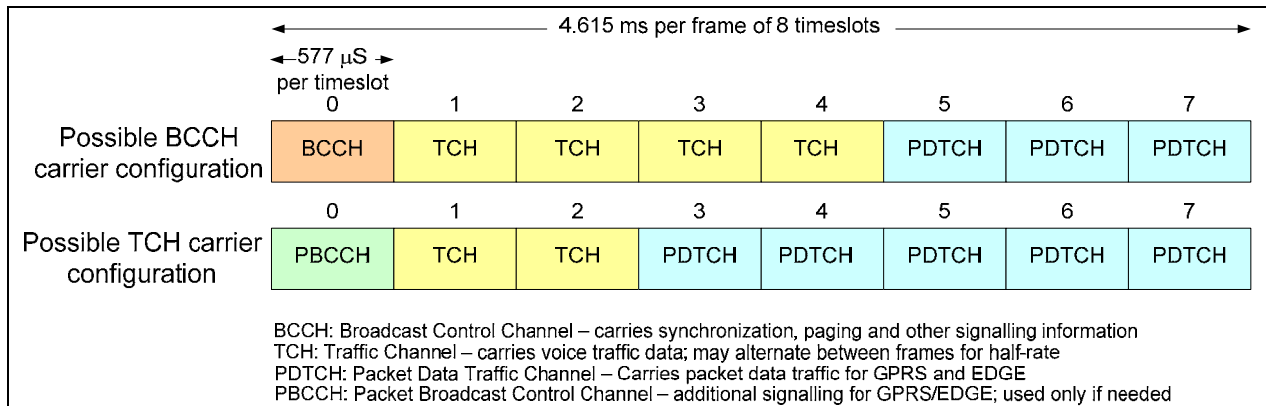

GPRS/EDGE offers close coupling between voice and data services. While in a data session, users can accept an incoming voice call, which suspends the data session, and then resume their data session automatically when the voice session ends. Users can

also receive SMS messages and data notifications¹⁵ while on a voice call. Future GSM networks will support simultaneous voice/data operation.

With respect to data performance, each data timeslot can deliver peak user-achievable data rates of about 10 kbps with GPRS¹⁶ and up to about 50 kbps with EDGE. The network can aggregate up to four of these on the downlink with current devices.

If there are multiple data users active in a sector, they share the available data channels. However, as demand for data services increases, operators can accommodate customers by assigning an increasing number of channels for data service limited only by their total available spectrum and radio planning.

While GPRS provides an effective data solution, EDGE offers many advantages. EDGE has proven extremely effective in field deployments, by not only boosting data rates and increasing capacity but also providing a resilient data link that translates into reliable application performance.

EDGE is an official 3G cellular technology that can be deployed within an operator's existing 850, 900, 1,800, and 1,900 MHz spectrum bands. A powerful enhancement to GSM/GPRS networks, EDGE increases data rates by a factor of three over GPRS and doubles data capacity using the same portion of an operator's valuable spectrum. It does so by enhancing the radio interface while allowing all other network elements, including Base Station Controller (BSC), SGSN, GGSN, and HLR, to remain mostly the same.

EDGE capability is now largely standard in new GSM deployments. It is also available as a software-based upgrade for newer GSM/GPRS¹⁷ networks. A GPRS network using the EDGE radio interface is technically called an Enhanced GPRS (EGPRS) network, and a GSM network with EDGE capability is referred to as GERAN. EDGE is an inherent part of GSM specifications since release 99 and is fully backward compatible with older GSM networks, meaning GPRS devices work on EDGE networks, GPRS and EDGE terminals can operate simultaneously on the same traffic channels, and any application developed for GPRS will also work with EDGE.

EDGE employs three advanced techniques in the radio link that allow it to achieve extremely high spectral efficiency for narrowband cellular-data¹⁸ services. The first technique is the addition of a modulation scheme called Octagonal Phase Shift Keying (8-PSK) that allows the radio signal to transmit three bits of information in each radio symbol¹⁹. In contrast, before Release 99, GSM/GPRS networks used only Gaussian Minimum Shift Keying (GMSK), which transmits one bit of information per radio symbol. The second technique employs multiple coding schemes, where the network can adjust the number of bits dedicated to error control based on the radio environment. EDGE has five coding schemes available for 8-PSK and four coding schemes for GMSK, thus providing up to nine different modulation and coding schemes (see Table 2). Evolved

¹⁵ Example: WAP notification message delivered via SMS.

¹⁶ Using GPRS coding schemes 1 and 2, which are the most common in deployments.

¹⁷ Assumes GSM Release 99. GSM Release 5 features require some enhancements to the core network.

¹⁸ *Narrowband data* refers to rates of up to about 100 kbps.

¹⁹ A *radio symbol* is the momentary change of phase, amplitude, or frequency to the carrier signal to encode binary data.

EDGE, as discussed below, will include the addition of new modulation and coding schemes, as well as the possibility of higher symbol rates.

EDGE dynamically selects the optimum modulation and coding scheme for the current radio environment in a process called link adaptation. In the third technique, if blocks of data are received in error, EDGE retransmits data using different coding. The newly received information is combined with the previous transmissions, significantly increasing the likelihood of a successful transmission. This mechanism, which provides an effective link gain of around 2 decibels (dB), assures the fastest possible receipt of correct data and is called *incremental redundancy*.

Table 2 shows the different modulation and coding schemes for EDGE.

Table 2: EDGE Modulation and Coding Schemes²⁰

Modulation and Coding Scheme	Modulation	Throughput per Timeslot (kbps)
MCS-9	8-PSK	59.2
MCS-8	8-PSK	54.4
MCS-7	8-PSK	44.8
MCS-6	8-PSK	29.6
MCS-5	8-PSK	22.4
MCS-4	GMSK	17.6
MCS-3	GMSK	14.8
MCS-2	GMSK	11.2
MCS-1	GMSK	8.8

The resulting throughput per GSM timeslot at the link layer with EDGE can vary from 8.8 kbps under adverse conditions to 59.2 kbps with a very good Carrier to Interference (C/I) ratio. In comparison, GPRS based on GMSK delivers 12 kbps with coding scheme 2 (the most commonly used scheme today) and 20 kbps with the optional coding scheme 4²¹. GSM with EDGE can theoretically provide 59.2 kbps in each of eight timeslots, adding up to a peak network rate of 473.6 kbps in eight timeslots. Today's devices aggregate up to four timeslots and result in peak user-achievable rates of 200 kbps, measured at the application level, and typical data rates in the 100 to 130 kbps range.

By sending more data in each timeslot, EDGE also increases spectral efficiency by 150 percent relative to GPRS using coding schemes 1 and 2.

EDGE makes full use of the capacity in the available radio spectrum. In this regard, EDGE is as effective a technique for expanding data capacity as the AMR codec is for expanding voice capacity. The two working together results in GSM being an extremely efficient cellular technology, one that continues to serve operators well.

²⁰ Radio Link Control (RLC) – layer 2 - throughputs. Application rates are typically 20 percent lower.

²¹ RLC throughputs. Layer 1 throughputs are 13.4 kbps per timeslot for CS2 and 21.4 kbps per timeslot for CS4.

Since higher order modulation (8-PSK) and low coding rates require higher C/I, one question is whether the higher rates are available throughout the entire coverage area. And EDGE will indeed provide these rates. Two sets of curves illustrate the performance gain (see Figures 4 and 5). The first, shown in Figure 4, illustrates downlink throughput (kbps per timeslot) versus path-loss distance out to 11 kilometers (km). The average gain over this distance for EGPRS over GPRS coding schemes 1 through 4 is 2.6. The average gain over GPRS coding schemes 1 and 2 is 3.6.

Figure 4: Throughput versus Distance for EGPRS/EDGE²²

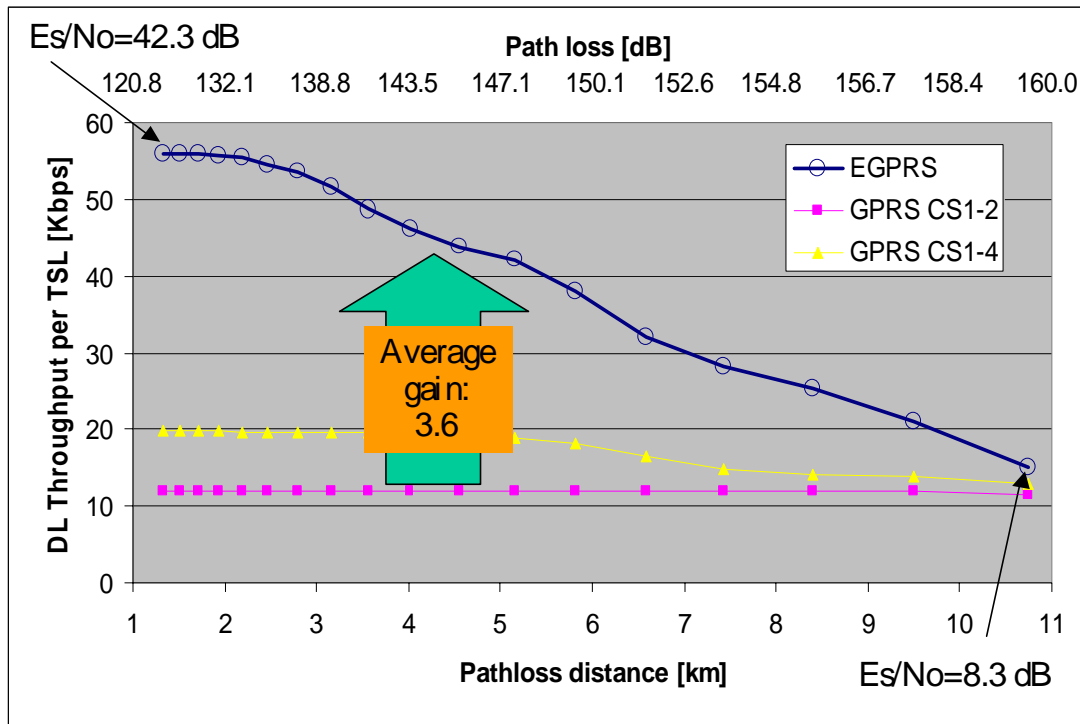

The second curve, as shown in Figure 5, depicts throughput per timeslot versus C/I:

- ❑ 15 percent of the coverage area, shown in the yellow section, experiences a two-fold performance improvement relative to GPRS (coding schemes 1 and 2).
- ❑ 70 percent of the coverage area, shown in the green and blue sections, experiences a four-fold performance improvement.
- ❑ 15 percent of the coverage area, shown in the pink section, experiences a five-fold performance improvement.

²² Source: 3G Americas' member company. Coverage limited scenario. DL refers to downlink and TSL refers to timeslot.

Figure 5: EDGE Performance Improvement Over Coverage Area²³

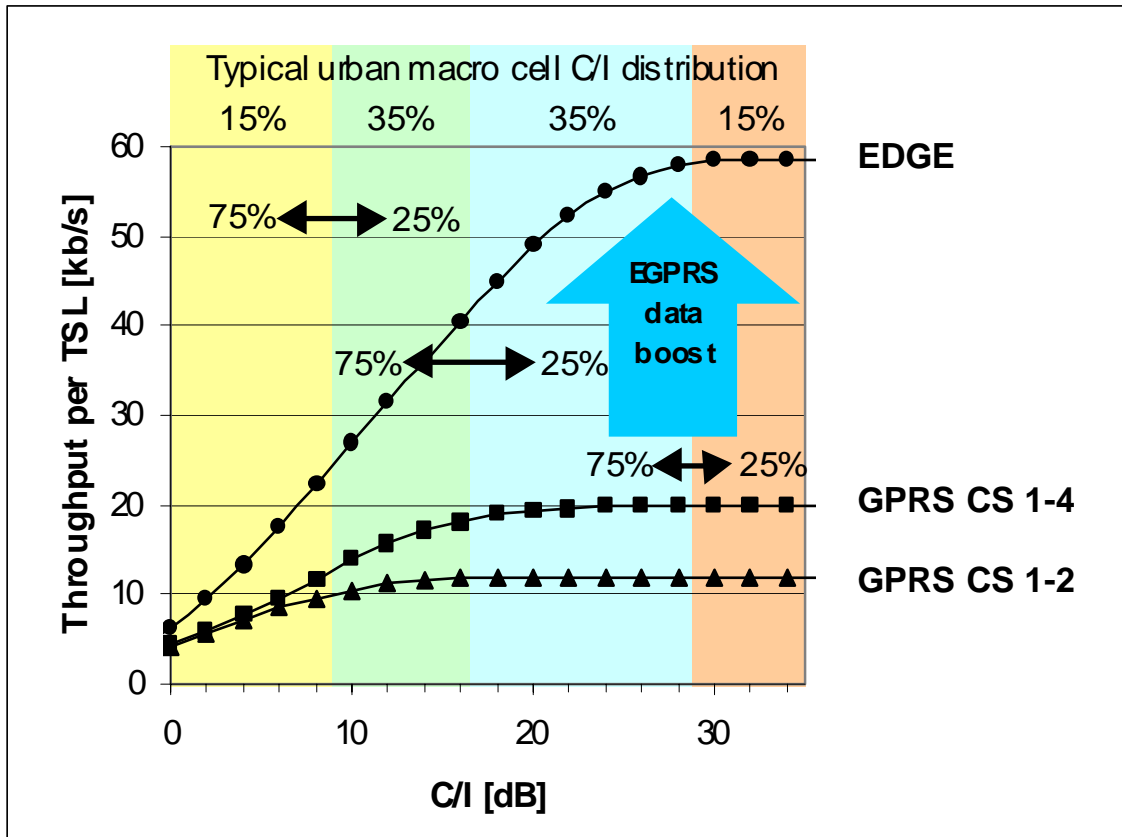

In Figure 5, the horizontal double-tipped arrows show how the 15 percent, 50 percent and 85 percent colored borders that depict the C/I distribution in the cell shift depending on network load²⁴. The diagram uses a 50 percent network load, and the arrows show how C/I and throughputs vary between 25 and 75 percent network loads.

Beyond improvements in radio performance, EDGE supports another important feature: the same QoS architecture as used by UMTS, which is discussed in the next section. This architecture is based on Release 99 of the 3GPP specifications. Successive releases build on this foundation, with support added for services such as multimedia and VoIP telephony.

With respect to deployment, the GSM network can allocate GPRS and EDGE timeslots in the 5/15 or 4/12 reuse layer²⁵ (which includes the broadcast control channel) as well as in the 1/3 reuse or even the 1/1 reuse hopping layers. This flexibility facilitates the launch of data services with a certain amount of data capacity and allows this capacity to be readily increased as required.

²³ Source: 3G Americas' member companies. 7 Km cell site distance, 1/3 reuse.

²⁴ Network load represents what percentage of the timeslots in the system are fully utilized. For example, 100 percent load means all timeslots across the system are fully utilized at full power, and 50 percent load means half of the timeslots across the system are in use at full power.

²⁵ 4/12 reuse means that available radio channels are used across four cells, each with three sectors. Each sector has 1/12 of the total channels. The pattern is repeated every four cells.

With the data capabilities and spectral efficiency of EDGE, along with the spectral efficiency of GSM for voice services, operators can use GSM technology to deliver a broad range of data services that will satisfy their customers for quite some time.

EDGE Deployment

Although EDGE is a highly sophisticated radio technology, it uses the same radio channels and timeslots as any GSM and GPRS system, so it does not require additional spectral resources except to accommodate loading. By deploying EDGE, operators can use their existing spectrum more efficiently. Most new GSM networks deployed today include EDGE. For many GSM/GPRS networks in areas such as the Americas, EDGE was mostly a software upgrade to the Base Transceiving Station (BTS) and the BSCs, as the transceivers in these networks are already EDGE capable. Some carriers have reported the cost of upgrading to EDGE from GSM/GPRS to be as low as \$1 to \$2 per POP²⁶. The same packet infrastructure supports both GPRS and EDGE. An increasing number of GPRS terminals support EDGE, thus making EDGE available to more subscribers.

Many operators that originally planned to use only UMTS for next-generation data services have deployed or are now deploying EDGE as a complementary 3G technology. There are multiple reasons for this, including:

1. EDGE provides a high-capability data service in advance of UMTS.
2. EDGE provides average data capabilities for the “sweet spot” of approximately 100 kbps, enabling many communications-oriented applications.
3. EDGE has proven itself in the field as a cost-effective solution and is now a mature technology.
4. EDGE is very efficient spectrally, allowing operators to support more voice and data users with existing spectrum.
5. Operators can maintain their EDGE networks as a complementary service offering, even as they deploy UMTS/HSPA.
6. EDGE provides a cost-effective wide-area data service that offers continuity and that is complementary with a UMTS/HSDPA network deployed in high traffic areas.

It is important to note that EDGE technology is continuing to improve. For example, Release 4 significantly reduced EDGE latency (network round-trip time)—from the typical 500 to 600 msec to about 300 msec. Release 7 will also include significant new features for EDGE.

Devices themselves are increasing in capability. Dual Transfer Mode (DTM) devices, already available from vendors, will allow simultaneous voice and data communications with both GPRS and EDGE devices. For example, during a voice call users will be able to retrieve e-mail, do multimedia messaging, browse the Web, and do Internet conferencing. This is particularly useful when connecting phones to laptops via cable or Bluetooth and using them as modems.

DTM is a 3GPP-specified technology that enables new applications like video sharing while providing a consistent service experience (service continuity) with UMTS. Typically, a DTM end-to-end solution requires only a software upgrade to the GSM/EDGE radio network.

²⁶ POP refers to population.

EDGE Evolution

Recognizing the value of the huge installed base of GSM networks, 3GPP is currently working to improve EDGE capabilities for Release 7. This work is part of the GERAN Evolution effort, which also includes voice enhancements not discussed in this paper.

Although EDGE today already serves many applications, such as wireless e-mail, extremely well, it makes good sense to continue to evolve EDGE capabilities. From an economic standpoint, it is less costly than upgrading to UMTS because most enhancements are designed to be software based, and highly asset efficient because it involves less long-term capital investments to upgrade an existing system. With 82 percent of the world market using GSM, which is already equipped for simple roaming and billing, it is easy to offer global service to subscribers.

Evolved EDGE offers higher data rates and system capacity; cable modem speeds are realistically achievable. Evolved EDGE mobiles will be much less expensive and offer greater talk and standby times than UMTS mobiles. UMTS mobile stations also incorporate GSM capability, and two radios are more expensive and consume more power than one radio.

Evolved EDGE also provides better service continuity between EDGE and HSPA, meaning that a user will not have a hugely different experience when moving between environments.

Although GSM and EDGE are already highly optimized technologies, advances in radio techniques enable further efficiencies. Some of the objectives of Evolved EDGE include:

- ❑ A 100-percent increase in peak data rates
- ❑ A 50-percent increase in spectral efficiency and capacity in C/I-limited scenarios
- ❑ A sensitivity increase in the downlink of 3 dB for voice and data
- ❑ Reduction of latency for initial access and round-trip time, enabling support for conversational services such as VoIP and PoC
- ❑ Achieving compatibility with existing frequency planning, thus facilitating deployment in existing networks
- ❑ Coexisting with legacy mobile stations by allowing both old and new stations to share the same radio resources
- ❑ Avoiding impacts on infrastructure by enabling improvements through a software upgrade
- ❑ Applicability for DTM (simultaneous voice and data) and the A/Gb mode interface. The A/Gb mode interface is part of the 2G core network, so this goal is required for full backward compatibility with legacy GPRS/EDGE

The methods being standardized in Release 7 to achieve these objectives include:

- ❑ Adding 16 Quadrature Amplitude Modulation (16-QAM) and a new set of modulation/coding schemes that will increase maximum throughput per timeslot by 38 percent. Currently, EDGE uses 8-PSK modulation. Simulations indicate a realizable 25 percent increase in user-achievable peak rates.
- ❑ Allowing reception on two distinct radio channels to increase the number of simultaneous timeslots. A type 2-enhanced EDGE device (which can simultaneously transmit and receive) will be able to receive up to 16 timeslots in two radio channels as well as transmit on up to eight timeslots in one radio channel.

- ❑ Reducing the Transmission Time Interval (TTI) to reduce overall latency. This will have a dramatic effect on application throughput for many applications.
- ❑ Downlink diversity reception of the same radio channel to increase the robustness in interference and improve the receiver sensitivity. Sensitivity gains of 3 dB and a decrease in required C/I of up to 18 dB for a single co-channel interferer are shown in simulations. Significant increases in system capacity can be achieved, as explained below.

Dual-Carrier Receiver

A key part of the evolution of EDGE is the utilization of more than one radio frequency carrier. This overcomes the inherent limitation of the narrow channel bandwidth of GSM. Using two radio-frequency carriers requires two receiver chains in the downlink, as shown in the following figure. Using two carriers enables the reception of twice as many radio blocks simultaneously or, alternatively, the original number of radio blocks can be divided between the two carriers, thus reducing the transmission time by half, and avoiding the potential need for simultaneous transmission and reception.

Figure 6: EDGE Multi-Carrier Receive Logic – Mobile Part

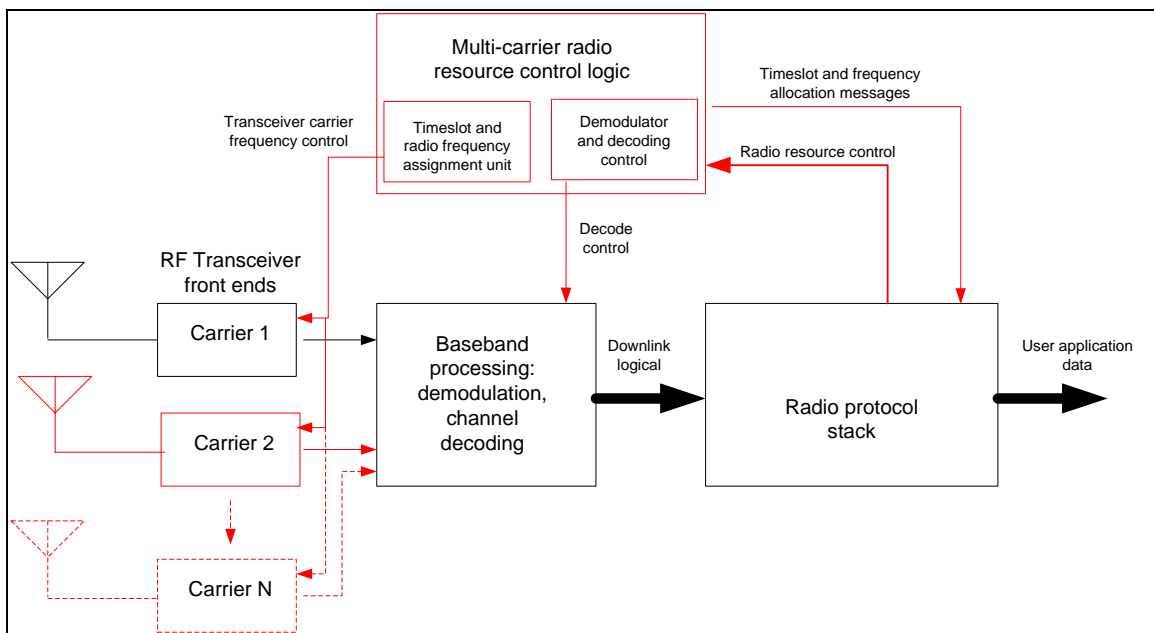

Channel capacity with dual-carrier reception improves greatly, not by increasing basic efficiencies of the air-interface but because of statistical improvement in the ability to assign radio resources, which increases trunking efficiency.

As network loading increases, it is statistically unlikely that contiguous timeslots will be available. With today's EDGE devices, it is not possible to change radio frequencies when going from one timeslot to the next. However, with an Evolved EDGE dual receiver this becomes possible, thus enabling contiguous timeslots across different radio channels. Figure 7 shows a dual-radio receiver approach optimizing the usage of available

timeslots. "R1" refers to receiver 1, "R2" refers to receiver 2, and "M2" refers to receiver 2 doing system monitoring.²⁷

Figure 7: Optimization of Timeslot Usage Example

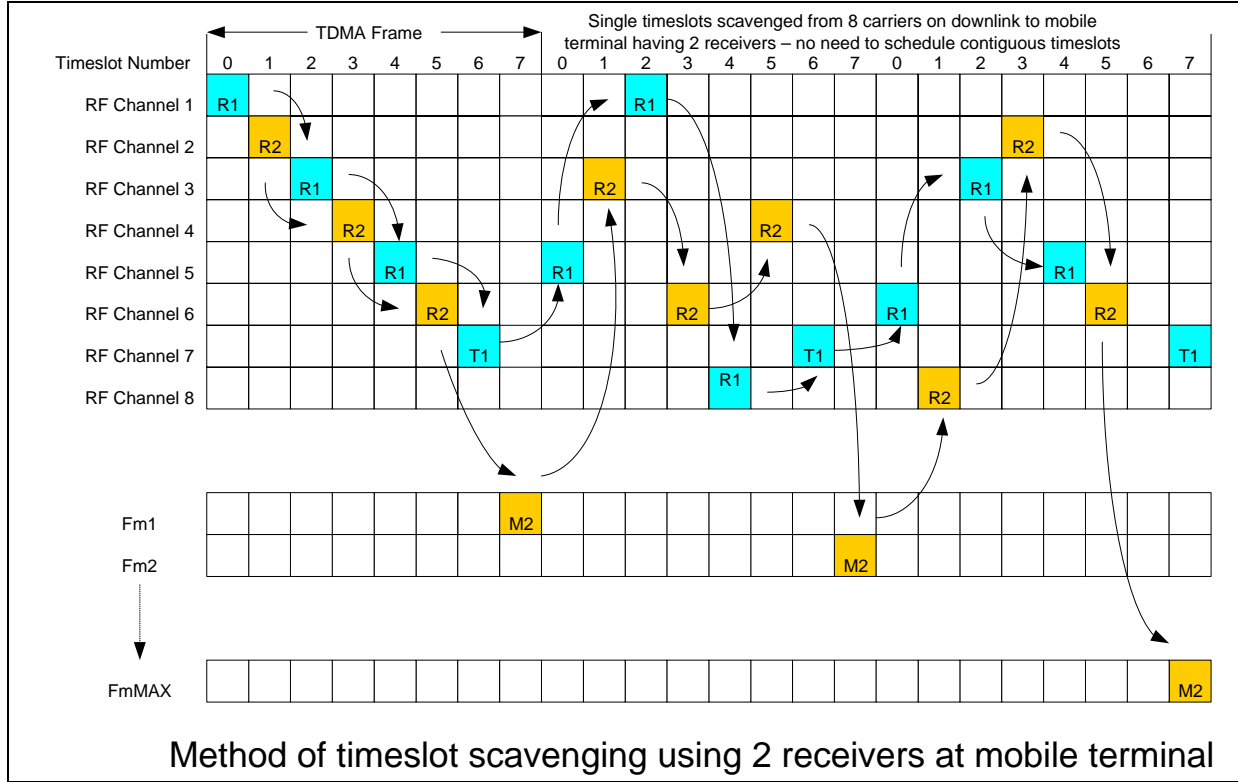

Through intelligent selection, the dual-carrier receiver architecture can support either dual-carrier reception or mobile station receive diversity, depending on the operation environment.

Mobile Station Receive Diversity

Figure 8 illustrates how mobile station receive diversity increases system capacity. BCCH refers to the Broadcast Control Channel and TCH refers to the Traffic Channel. The BCCH carrier repeats over 12 cells in a 4/12 frequency reuse pattern, which requires 2.4 MHz for GSM. A fractionally loaded system may repeat f12 through f15 on each of the cells. This is a 1/1 reuse pattern with higher system utilization but potentially also high co-channel interference in loaded conditions.

²⁷ Fm 1..FmMax are "measurement frequencies." These are different RF channels on which the mobile measures adjacent cell Received Signal Strength Indication (RSSI) and may also be required to read the Frequency Correction Burst (FCB) and Synchronization Channel (SCH). M1 and M2 are measurements performed by receiver 1 and receiver 2 respectively.

Figure 8: Example of 4/12 Frequency Reuse with 1/1 Overlay

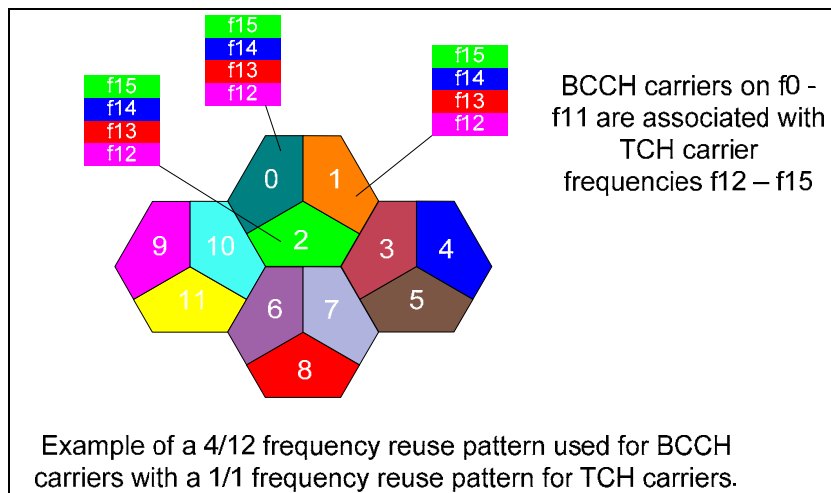

In today's EDGE systems, the frequencies f12-f15 in the 1/1 re-use layer can only be loaded to around 25 percent of capacity. Thus, with four of these frequencies, it's possible to obtain 100 percent of the capacity of the frequencies in the 4/12 reuse layer, or double the capacity by adding 800 KHz of spectrum.

However, using Evolved EDGE and receive-diversity-enabled mobiles that have a high tolerance to co-channel interference, it's possible to increase the load on the 1/1 layer from 25 to 50 percent, and possibly as high as 75 percent. An increase to 50 percent translates to a doubling of capacity on the 1/1 layer without requiring any new spectrum and a 200-percent gain compared to a 4/12 reuse layer.

Higher Order Modulation Schemes

The addition of higher order modulation schemes enhances EDGE network capacity with little capital investment by extending the range of the existing wireless technology. More bits per symbol mean more data transmitted per unit time. This yields a fundamental technological improvement in information capacity and faster data rates. Use of higher order modulation exploits localized optimal coverage circumstances, thereby taking advantage of the geographical locations associated with probabilities of high C/I ratio and enabling very high data transfer rates whenever possible.

These enhancements are only now being considered because factors such as processing power and variability of interference and signal level made higher order modulations impractical for mobile wireless systems just a few years ago. However, newer techniques for demodulation, such as advanced receivers and receive diversity, help enable their use. Realization of 16-QAM is planned for Release 7. Advanced equalizer research has shown that 32 and 64-QAM are also possible, and this is currently being studied for future releases.

Table 3 shows the theoretical peak throughput for four slots and considers only fundamental improvements, shown in the new Evolved EDGE Modulation and Coding Scheme (MCS) 10 and MCS 11.

Table 3: Comparison of Current EDGE and Evolved EDGE²⁸

Modulation and Coding Scheme (MCS)	Current EDGE		Evolved Edge	
	Description	Throughput (kbps) – 4 slots	Description	16-QAM Edge Enhancement Throughput (kbps) – 4 slots
MCS-1	GMSK	35.2	GMSK	35.2
MCS-2	GMSK	44.8	GMSK	44.8
MCS-3	GMSK	59.2	GMSK	59.2
MCS-4	GMSK	70.4	GMSK	70.4
MCS-5	8-PSK	89.6	8-PSK	89.6
MCS-6	8-PSK	118.4	8-PSK	118.4
MCS-7	8-PSK	179.2	8-PSK	179.2
MCS-8	8-PSK	217.6	8-PSK	217.6
MCS-9	8-PSK	236.8	8-PSK	236.8
MCS-10	N/A	N/A	16-QAM with turbo codes	268.8
MCS-11	N/A	N/A	16-QAM uncoded	326.4

Type 2 Mobile Stations

A Type 2 GSM mobile station is a mobile terminal capable of simultaneous transmission and reception. Although this was standardized in the mid-1990s, it was never implemented by device manufacturers because the required duplexers consumed a lot of space and often induced a loss of greater than 6 dB in the radio path. Today, duplexers are extremely small Film Bulk Acoustic Resonator (FBAR) devices having very low loss. Figure 9 shows the difference between Type 1 and Type 2 devices.

²⁸ RLC throughput.

Figure 9: Simultaneous Transmission/Reception

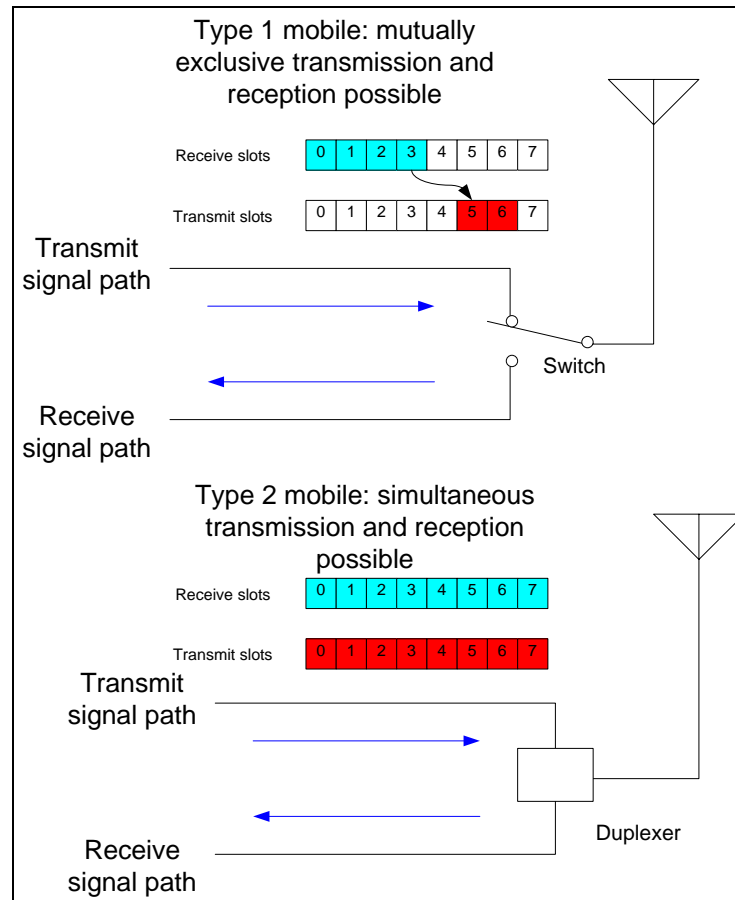

Type 2 operation is important because it enables the mobile station to transmit and receive on multiple timeslots simultaneously, significantly improving peak achievable data rates.

The combination of Release 7 EDGE Evolution enhancements shows a dramatic potential increase in throughput. For example, in the downlink, a Type 2 mobile using MCS-11 as the modulation and coding scheme and a dual-carrier receiver can achieve the following performance:

- Data rate per timeslot (layer 2) = 81.6 kbps
- Timeslots per carrier = 8
- Carriers used in the downlink = 2
- Total downlink data rate = 81.6 kbps X 8 X 2 = 1305.6 kbps

This translates to a user-achievable data rate of over 1 Mbps!

Other Methods Under Consideration

This paper has emphasized those Evolved EDGE features that 3GPP has agreed upon for Release 7. However, there are other features being proposed that would boost EDGE capabilities even further. These include advanced modulation, higher uplink symbol rates and uplink dual carrier.

Advanced modulation includes enhancements to existing modulation and coding schemes. This can be achieved, for example, by increasing the modulation for MCS 7 through 9 to 16-QAM using turbo coding, as well as increasing the modulation for MCS 1 through 4 to Quadrature Phase Shift Keying (QPSK). Other possibilities include the use of 32-QAM or 64-QAM modulation in areas of high C/I ratio.

Throughputs could double in the uplink with the introduction of 1.5 times higher symbol rate and 16QAM on the uplink, based on new modulation and coding schemes that would have double the bit rate, yielding 473.6 kbps peak throughput with 4 uplink slots. The higher symbol rate requires new modulators for the mobile station, but may or may not require network hardware upgrade. The mobile output power requires an additional backoff to limit interference at the base station, such that the impact to voice is expected to be negligible. The higher symbol rate on the uplink can also significantly enhance coverage.

A second uplink carrier could also double uplink throughput. Two approaches have been discussed. The first is a fully flexible dual transmitter approach. This approach has no network impacts but may have significant impacts on the feasibility of the mobile station, particularly in the handheld form factor, and is currently being researched and discussed. The second approach is a constrained form of uplink dual carrier, where the spacing of the two carriers is less than 1 MHz, and a single wideband transmitter generates the signal. This approach is easier to implement in a mobile handset, but may have impacts on legacy frequency planning. Proposals have been put forward outlining ways to coexist with legacy frequency planning; these ideas are being researched and discussed.

In conclusion, it is interesting to note the sophistication and capability achievable with GSM.

UMTS/HSPA Technology

Universal Mobile Telecommunications System has garnered the overwhelming majority of new 3G spectrum licenses, with well over 100 commercial networks already in operation. Compared to emerging wireless technologies, UMTS technology is mature and benefits from research and development that began in the early 1990s. It has been thoroughly trialed, tested, and commercially deployed. UMTS deployment is now accelerating with stable network infrastructure and attractive, reliable mobile devices with rich capabilities.

UMTS employs a wideband CDMA radio-access technology. The primary benefits of UMTS include high spectral efficiency for voice and data, simultaneous voice and data capability for users, high user densities that can be supported with low infrastructure cost, support for high-bandwidth data applications, and a clean migration to VoIP in the future. Operators can also use their entire available spectrum for both voice and high-speed data services.

Additionally, operators will be able to use a common core network that supports multiple radio-access networks, including GSM, GPRS, EDGE, WCDMA, HSDPA, and evolutions of these technologies. This common core network can use the same network elements as GPRS, including SGSN, GGSN, MSC, and HLR. This is called the UMTS multi-radio network, and it gives operators maximum flexibility in providing different services across their coverage areas (see Figure 10).

Figure 10: UMTS Multi-Radio Network

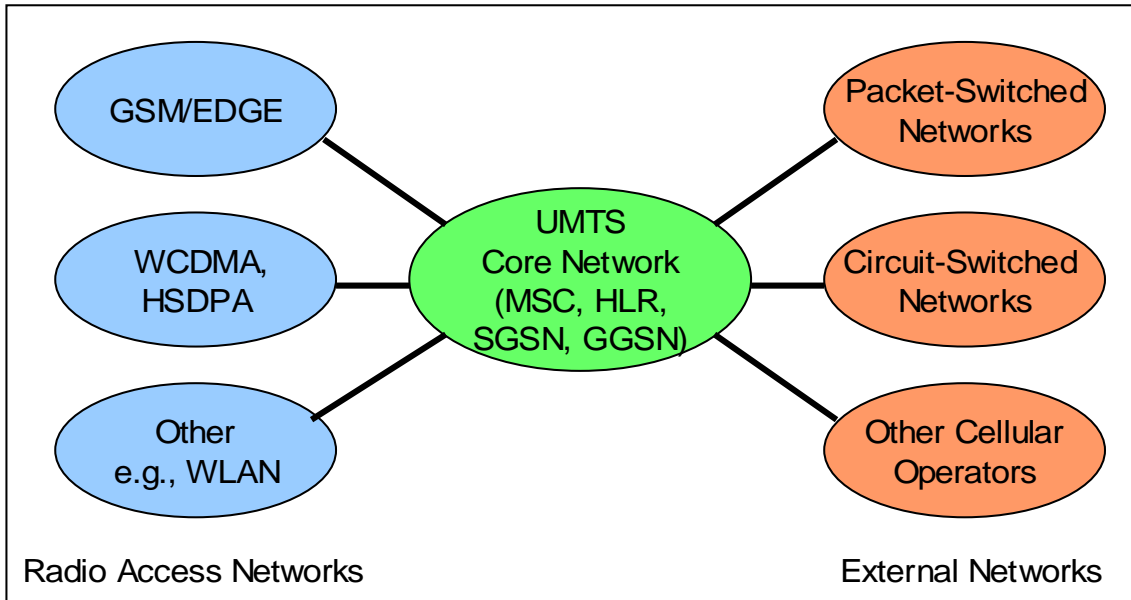

The UMTS radio-access network consists of base stations referred to as a Node B (corresponding to GSM base transceiver systems) that connect to radio network controllers (corresponding to GSM base station controllers). The Radio Network Controllers (RNC) connect to the core network, as do the BSCs. When both GSM and WCDMA access networks are available, the network can hand over users between these networks. This is important for managing capacity as well as in areas where the operator has continuous GSM coverage but has only deployed WCDMA in some locations.

Whereas GSM can effectively operate like a spread-spectrum system²⁹ based on time division in combination with frequency hopping, WCDMA is a direct-sequence spread-spectrum system. WCDMA is spectrally more efficient than GSM, but it is the wideband nature of WCDMA that provides its greatest advantage—the ability to translate the available spectrum into high data rates. This wideband technology approach results in the flexibility to manage multiple traffic types, including voice, narrowband data, and wideband data.

WCDMA allocates different codes for different channels, whether for voice or data, and it can adjust the amount of capacity, or code space, of each channel every 10 msec with WCDMA Release 99 and every 2 msec with HSPA. WCDMA creates high-bandwidth traffic channels by reducing the amount of spreading (using a shorter code) and higher-order modulation schemes for HSPA. Packet data users can share the same codes as other users, or the network can assign users dedicated channels.

To further expand the number of effectively operating applications, UMTS employs a sophisticated QoS architecture for data that provides four fundamental traffic classes, including:

1. **Conversational.** Real-time interactive data with controlled bandwidth and minimum delay, such as VoIP or video conferencing.
2. **Streaming.** Continuous data with controlled bandwidth and some delay, such as music or video.

²⁹ Spread spectrum systems can either be direct sequence or frequency hopping.

3. **Interactive.** Back-and-forth data without bandwidth control and some delay, such as Web browsing.
4. **Background.** Lower priority data that is non-real-time, such as batch transfers.

This QoS architecture involves negotiation and prioritization of traffic in the radio-access network, the core network, and the interfaces to external networks such as the Internet. Consequently, applications can negotiate QoS parameters on an end-to-end basis between a mobile terminal and a fixed-end system across the Internet or private intranets. This capability is essential for expanding the scope of supported applications, particularly multimedia applications, including packetized video telephony and VoIP.

UMTS Release 99 Data Capabilities

In UMTS Release 99, the maximum theoretical downlink rate is just over 2 Mbps. Although exact throughput depends on the channel sizes the operator chooses to make available, the capabilities of devices, and the number of users active in the network, users can obtain peak throughput rates of 350 kbps in commercial networks. Peak downlink network speeds are 384 kbps. Uplink peak network throughput rates are also 384 kbps in newer deployments, with user-achievable peak rates of 350 kbps³⁰. This satisfies many communications-oriented applications.

Channel throughputs are determined by the amount of spreading of the channel. With more spreading, as in voice channels, the data stream has greater redundancy and the operator can employ more channels. In comparison, a high-speed data channel has less spreading and a fewer number of such channels available. Voice channels use downlink spreading factors of 128 or 256, whereas a 384 kbps data channel uses a downlink spreading factor of eight. The commonly quoted rate of more than 2 Mbps downlink throughput for UMTS can be achieved by combining three data channels of 768 kbps, each with a spreading factor of four.

The actual throughput speeds a user can obtain with WCDMA Release 99 depend on the Radio Access Bearer (RAB) assigned by the network. Possible values include 768 kbps, 384 kbps, 128 kbps, 64 kbps, 32 kbps, and 16 kbps. The different rates correspond to the amount of spreading. A lower degree of spreading results in more code space assigned to that RAB, hence higher throughput. In today's Release 99 networks, operators have limited the range of operational data rates using Release 99 channels to 384 kbps as a result of the emergence of HSDPA, which provides a much more elegant way to reach data throughput in the 2 Mbps range and higher.

Beyond the maximum throughput supported by the RAB assigned by the network, the user throughput is also impacted by the radio conditions and amount of data to transfer. These elements are taken into account by the Radio Access Network to continuously adjust the instantaneous transfer rate based on operational conditions, and within the QoS constraints of the RAB. The network assigns RABs based on available resources. How the network assigns RABs varies by infrastructure vendor.

WCDMA has significantly lower network latency than GPRS/EDGE, with about 100 to 200 msec measured in actual networks.

Although UMTS Release 99 offers attractive data services, they become much more efficient and more powerful with HSDPA.

³⁰ Initial UMTS networks had peak uplink rates of 64 kbps or 128 kbps, but many deployments emphasize 384 kbps.

HSDPA

High Speed Downlink Packet Access is a tremendous performance upgrade for packet data that delivers peak theoretical rates of 14 Mbps. Peak user-achievable throughput rates in initial deployments are well over 1 Mbps, three times faster than Release 99 data, and will increase over time with enhanced terminals and network capabilities. Specified as part of 3GPP Release 5, operators are now deploying HSDPA around the world. In the United States, Cingular Wireless will have HSDPA service in most major markets by the end of 2006. HSDPA is fully backward compatible with UMTS Release 99, and any application developed for Release 99 will work with HSDPA. The same radio carrier can simultaneously service UMTS voice and data users as well as HSDPA data users. HSDPA also has significantly lower latency, measured today on some networks as low as 70 msec on the HSDPA data channel.

HSDPA achieves its high speeds through techniques similar to those that amplify EDGE performance past GPRS, including higher order modulation, variable coding, and soft combining, as well as through the addition of powerful new techniques such as fast scheduling. HSDPA takes WCDMA technology to an elevated performance level for providing broadband services, and it has the highest theoretical peak throughput of any cellular technology currently available. The higher spectral efficiency and higher data rates not only enable new classes of applications but also support a greater number of users accessing the network.

HSDPA achieves its performance gains from the following radio features:

- ❑ High-speed channels shared in both the code and time domains
- ❑ Short TTI
- ❑ Fast scheduling and user diversity
- ❑ Higher order modulation
- ❑ Fast link adaptation
- ❑ Fast Hybrid Automatic Repeat Request (HARQ)

These features function as follows:

High-Speed Shared Channels and Short Transmission Time Interval: First, HSDPA uses high-speed data channels called High Speed Physical Downlink Shared Channels (HS-PDSCH). Up to 15 of these can operate in the 5 MHz WCDMA radio channel. Each uses a fixed spreading factor of 16. User transmissions are assigned to one or more of these channels for a short TTI of 2 msec, significantly less than the interval of 10 to 20 msec used in Release 99 WCDMA. The network can then readjust how users are assigned to different HS-PDSCH every two milliseconds. The result is that resources are assigned in both time (the TTI interval) and code domains (the HS-DSCH channels). Figure 11 illustrates different users obtaining different radio resources.

Figure 11: High Speed–Downlink Shared Channels (Example)

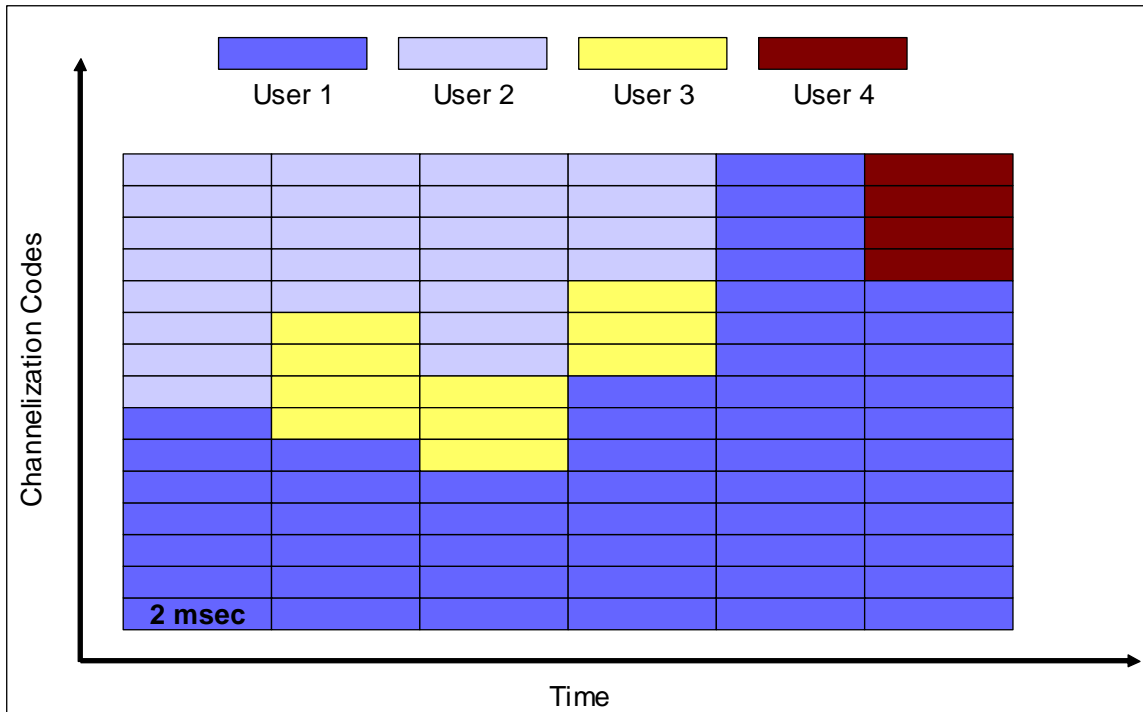

Fast Scheduling and User Diversity: Fast scheduling exploits the short TTI by assigning channels to the users with the best instantaneous channel conditions rather than in a round-robin fashion. Since channel conditions vary somewhat randomly across users, most users can be serviced with optimum radio conditions and thereby obtain optimum data throughput. Figure 12 shows how a scheduler might choose between two users based on their varying radio conditions to emphasize the user with better instantaneous signal quality. With about 30 users active in a sector, the network achieves significant user diversity and significantly higher spectral efficiency. The system also makes sure that each user receives a minimum level of throughput. This approach is sometimes called proportional fair scheduling.

Figure 12: User Diversity

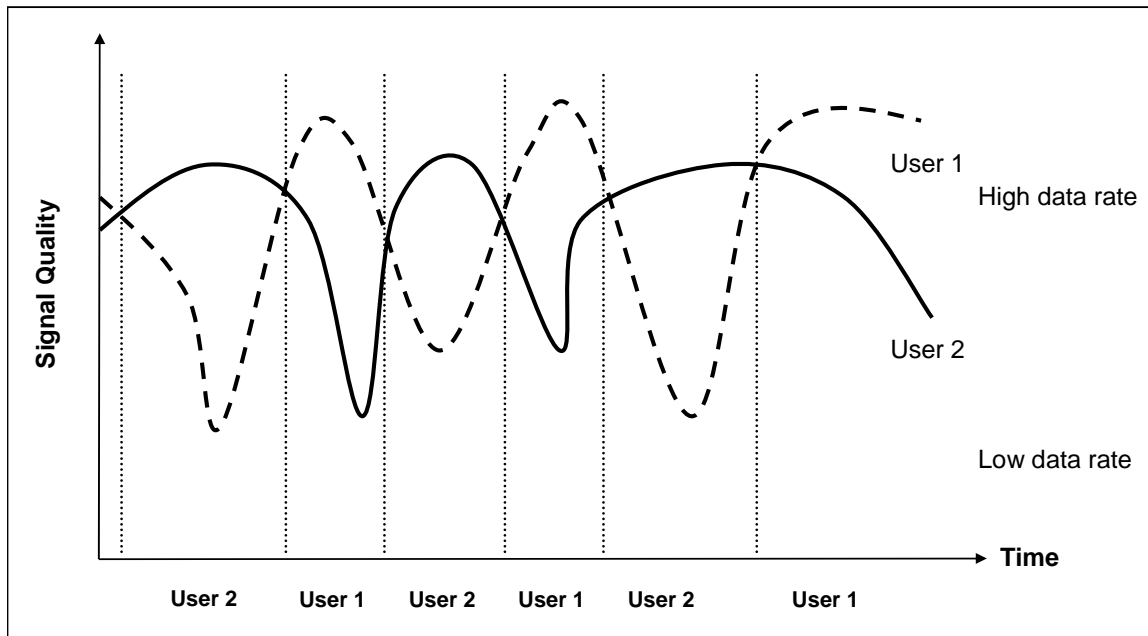

Higher Order Modulation: HSDPA uses both the modulation used in WCDMA, namely QPSK and, under good radio conditions, an advanced modulation scheme—16-QAM. The benefit of 16-QAM is that four bits of data are transmitted in each radio symbol as opposed to two bits with QPSK. 16-QAM increases data throughput, while QPSK is available under adverse conditions.

Fast Link Adaptation: Depending on the condition of the radio channel, different levels of forward-error correction (channel coding) can also be employed. For example, a three-quarter coding rate means that three quarters of the bits transmitted are user bits and one quarter is error-correcting bits. The process of selecting and quickly updating the optimum modulation and coding rate is referred to as fast link adaptation. This is done in close coordination with fast scheduling, described above.

Fast Hybrid Automatic Repeat Request: Another HSDPA technique is Fast Hybrid Automatic Repeat Request (Fast Hybrid ARQ.) “Fast” refers to the medium-access control mechanisms implemented in Node-B (along with scheduling and link adaptation) as opposed to the BSC in GPRS/EDGE, and “hybrid” refers to a process of combining repeated data transmissions with prior transmissions to increase the likelihood of successful decoding. Managing and responding to real-time radio variations at the base station, as opposed to an internal network node, reduces delays and further improves overall data throughput.

Using the approaches just described, HSDPA maximizes data throughputs and capacity and minimizes delays. For users, this translates to better network performance under loaded conditions, faster application performance, a greater range of applications that function well, and increased productivity.

Field results validate the theoretical throughput results. Using devices based on five codes and QPSK modulation (capable of 1.8 Mbps peak rates), vendors have measured consistent throughput rates well in excess of 1 Mbps³¹.

Initial HSDPA devices had peak rates of 1.8 Mbps³². By the second half of 2006, users will be able to purchase both HSDPA handsets and data cards supporting peak network rates of 3.6 Mbps. In 2007, devices with peak data rates of 7.2 Mbps will become available. Later sections of this paper discuss performance in greater detail, including the rates users can realistically achieve with different categories of devices, and throughput distributions in representative scenarios.

Table 4 shows the different categories of HSDPA devices defined. Soft channel bits refers to how many bits the system uses for error correction.

Table 4: HSDPA Terminal Categories

HS-DSCH Category	Maximum number of HS-DSCH codes	L1 Peak Rate (Mbps)	QPSK/ 16QAM	Soft Channel Bits
Category 1	5	1.2	Both	19200
Category 2	5	1.2	Both	28800
Category 3	5	1.8	Both	28800
Category 4	5	1.8	Both	38400
Category 5	5	3.6	Both	57600
Category 6	5	3.6	Both	67200
Category 7	10	7.2	Both	115200
Category 8	10	7.2	Both	134400
Category 9	15	10.2	Both	172800
Category 10	15	14.4	Both	172800
Category 11	5	0.9	QPSK	14400
Category 12	5	1.8	QPSK	28800

The attraction of HSDPA is that it is fully compatible with WCDMA Release 99 and can be deployed as a software-only upgrade to newer WCDMA networks. This approach has already been proven extremely effective with GPRS upgrades to EDGE. HSDPA, which uses many of the same proven radio techniques that EDGE applied to GPRS, is essentially the same approach applied to WCDMA. WCDMA Release 99 provided the initial foundation while HSDPA and HSUPA deliver the full inherent potential of the radio channel.

³¹ For example, on August 9, 2005, Vodafone Italy and Nokia announced HSDPA test results of 1.5 Mbps peak throughput.

³² Throughput available above the physical layer using QPSK modulation and a small amount of coding overhead.

High Speed Uplink Packet Access (HSUPA)

Whereas HSDPA optimizes downlink performance, High Speed Uplink Packet Access (HSUPA)—which uses the Enhanced Dedicated Channel (E-DCH)—constitutes a set of improvements that optimizes uplink performance. These improvements include higher throughputs, reduced latency, and increased spectral efficiency. HSUPA is standardized in Release 6. HSUPA will result in an approximately 85 percent increase in overall cell throughput on the uplink and an approximately 50 percent gain in user throughput. HSUPA also reduces packet delays.

Such an improved uplink will benefit users in a number of ways. For instance, some user applications transmit large amounts of data from the mobile station, such as sending video clips or large presentation files. For future applications such as VoIP, improvements will balance the capacity of the uplink with the capacity of the downlink.

HSUPA achieves its performance gains through the following approaches:

- ❑ An enhanced dedicated physical channel
- ❑ A short TTI, as low as 2 msec, which allows faster responses to changing radio conditions and error conditions
- ❑ Fast Node-B-based scheduling, which allows the base station to efficiently allocate radio resources
- ❑ Fast Hybrid ARQ, which improves the efficiency of error processing

The combination of TTI, fast scheduling, and Fast Hybrid ARQ also serves to reduce latency, which can benefit many applications as much as improved throughput. HSUPA can operate with or without HSDPA in the downlink, though it is likely that most networks will use the two approaches together. The improved uplink mechanisms also translate to better coverage, and for rural deployments, larger cell sizes.

HSUPA can achieve different throughput rates based on various parameters, including the number of codes used, the spreading factor of the codes, the TTI value, and the transport block size in bytes, as illustrated in Table 5.

Table 5: HSUPA Peak Throughput Rates

HSUPA Category	Codes x Spreading	TTI	Transport Block Size	Data Rate
1	1 x SF4	10	7296	0.73 Mbps
2	2 x SF4	10	14592	1.46 Mbps
2	2 x SF4	2	2919	1.46 Mbps
3	2 x SF4	10	14592	1.46 Mbps
4	2 x SF2	10	20000	2 Mbps
4	2 x SF2	2	5837	2.9 Mbps
5	2 x SF2	10	20000	2 Mbps
6	2xSF2 + 2xSF4	10	20000	2 Mbps
6	2xSF2 + 2xSF4	2	11520	5.76 Mbps

Evolution of HSPA (HSPA+)

Wireless and networking technologists are developing a continual series of enhancements for HSPA, some of which are being specified in Release 6 and Release 7, and some of which are being studied for Release 8.

3GPP has specified a number of advanced receiver designs, including Type 1 which uses mobile receive diversity, Type 2 which uses channel equalization and Type 3, which includes a combination of receive diversity and channel equalization.

The first approach, specified in Release 6, is mobile-receive diversity. This technique relies on the optimal combining of received signals from separate receiving antennas. The antenna spacing yields signals that have somewhat independent fading characteristics. Hence, the combined signal can be more effectively decoded, which results in a downlink capacity gain of up to 50 percent when employed in conjunction with techniques such as channel equalization. Receive diversity is effective even for small devices such as PC Card modems and smartphones.

Current receiver architectures based on rake receivers are effective for speeds up to a few megabits per second. But at higher speeds, the combination of reduced symbol period and multipath interference results in inter-symbol interference and diminishes rake receiver performance. This problem can be solved by advanced receiver architectures such as channel equalizers that yield an additional 20 percent gain over HSDPA with receive diversity. Alternative advanced receiver approaches include interference cancellation and generalized rake receivers (G-Rake). Different vendors are emphasizing different approaches. However, the performance requirements for advanced receiver architectures are specified in 3GPP Release 6. The combination of mobile receive diversity and channel equalization (Type 3) is especially attractive as it results in a large gain independently of the radio channel.

What makes such enhancements attractive is that no changes are required to the networks except increased capacity within the infrastructure to support the higher bandwidth. Moreover, the network can support a combination of devices, including both earlier devices that do not include these enhancements and those that do. Device vendors can selectively apply these enhancements to their higher performing devices.

Another capability being standardized is Multiple Input Multiple Output. MIMO refers to a technique that employs multiple transmit antennas and multiple receive antennas, often in combination with multiple radios and multiple parallel data streams. The most common use of the term "MIMO" applies to spatial multiplexing. The transmitter sends different data streams over each antenna. Whereas multipath is an impediment for other radio systems, MIMO actually exploits multipath, relying on signals to travel across different communications paths. This results in multiple data paths effectively operating somewhat in parallel and, through appropriate decoding, in a multiplicative gain in throughput.

Tests of MIMO have proven very promising in WLANs operating in relative isolation, where interference is not a dominant factor. Spatial multiplexing MIMO should also benefit HSPA "hotspots" serving local areas such as airports, campuses, and malls, where the technology will increase capacity and peak data rates. However, in a fully loaded network with interference from adjacent cells, overall capacity gains will be more modest, in the range of 20 to 33 percent over mobile-receive diversity. Relative to a 1x1 antenna system, however, 2X2 MIMO can deliver cell throughput gain of about 80

percent. 3GPP is standardizing spatial multiplexing MIMO in Release 7 using Double Transmit Adaptive Array (D-TxAA).³³

Although MIMO can significantly improve peak rates, other techniques such as Space Division Multiple Access (SDMA)—also a form of MIMO—may be even more effective than MIMO for improving capacity in high spectral efficiency systems using a reuse factor of 1. 3GPP has enhanced the system to support SDMA operation as part of Release 6.

In Release 7, Continuous Packet Connectivity enhancements reduce the uplink interference created by dedicated physical control channels of packet data users when they have no user data to transmit. This helps increase the limit for the number of HSUPA users that can stay connected at the same time.

3GPP currently has a study item referred to as “HSPA Evolution” or “HSPA+” that is not yet in a formal specification development stage. The intent is to create a highly optimized version of HSPA that employs both Release 7 features and other incremental features such as interference cancellation and optimizations to reduce latency.

The goals of HSPA+ are to:

- ❑ Exploit the full potential of a CDMA approach before moving to an OFDM platform in 3GPP LTE.
- ❑ Achieve performance comparable to LTE in 5 MHz of spectrum.
- ❑ Provide smooth interworking between HSPA+ and LTE that facilitates operation of both technologies. As such, operators may choose to leverage the SAE planned for LTE.
- ❑ Allow operation in a packet-only mode for both voice and data.
- ❑ Be backward compatible with previous systems while incurring no performance degradation with either earlier or newer devices.
- ❑ Facilitate migration from current HSPA infrastructure to HSPA+ infrastructure.

Depending on the features implemented, HSPA+ could match, and possibly exceed, the potential performance capabilities of IEEE 802.16e-2005 (mobile WiMAX) in the same amount of spectrum, and could match LTE performance in 5 MHz.

HSPA, HSPA+ and other advanced functions provide a compelling advantage for UMTS over competing technologies: The ability today to support voice and data services on the same carrier and across the whole available radio spectrum, to offer these services simultaneously to users, to deliver data at ever-increasing broadband rates, and to do so in a spectrally efficient manner.

HSPA Voice over IP

Once HSDPA and HSUPA are available, operators will have the option of moving voice traffic over to these high-speed data channels using Voice over IP. This will eventually increase voice capacity, allow operators to consolidate their infrastructure on an IP platform, and enable innovative new applications that combine voice with data functions in the packet domain. VoIP becomes possible with Release 6, but it is enhancements in

³³ For further details on these techniques, refer to the 3G Americas white paper “Mobile Broadband: The Global Evolution of UMTS/HSPA. 3GPP Release 7 and Beyond.”

Release 7 that make VoIP highly efficient and thus attractive to network operators. VoIP will be implemented in conjunction with IMS, discussed later in this paper.

One attractive aspect of deploying VoIP with HSPA is that operators can smoothly migrate users over time from circuit-switched operation to packet-switched operation. Since the UMTS radio channel supports both circuit-switched voice and packet-switched data, some number of voice users can be on legacy circuit-switched voice and others can be on VoIP. Figure 13 shows the system voice capacity with the joint operation of circuit-switched and IP based voice services.

Figure 13: Ability for UMTS to Support Circuit and Packet Voice Users³⁴

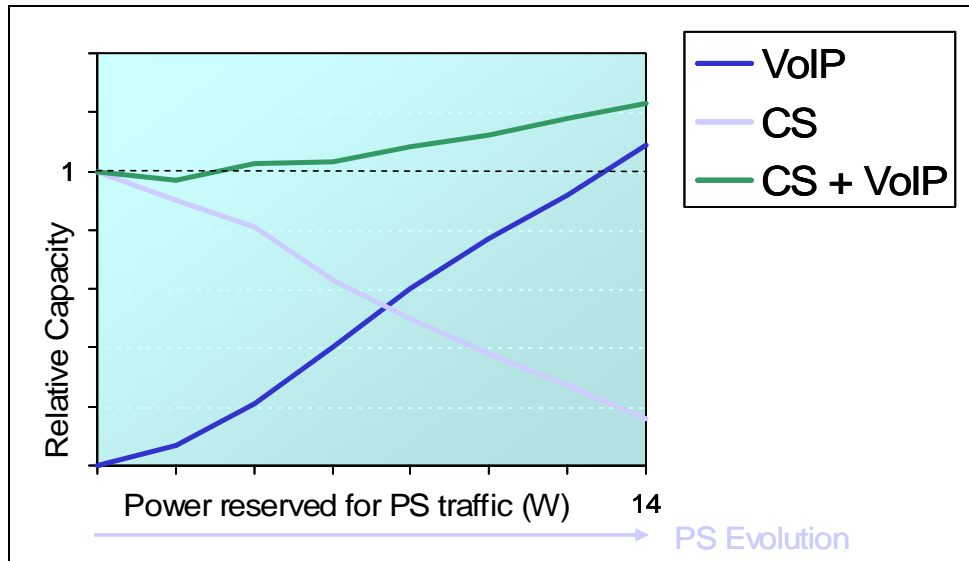

VoIP capacity gains are quantified in detail later in this paper, but they will range from 20 percent to as high as 100 percent with the implementation of interference cancellation. Operators are likely to emphasize packet voice in both HSPA+ and LTE.

3GPP Long Term Evolution (LTE)

Although HSPA and HSPA+ offer a highly efficient broadband wireless service that will likely enjoy success for the remainder of the decade, 3GPP is also working on a project called Long Term Evolution. LTE will allow operators to achieve even higher peak throughputs in higher spectrum bandwidth. Initial possible deployment is targeted for 2009.

LTE uses Orthogonal Frequency Division Multiple Access (OFDMA) on the downlink, which is well suited to achieve high peak data rates in high spectrum bandwidth. WCDMA radio technology is about as efficient as OFDM for delivering peak data rates of about 10 Mbps in 5 MHz of bandwidth. However, achieving peak rates in the 100 Mbps range with wider radio channels would result in highly complex terminals and is not practical with current technology. It is here that OFDM provides a practical implementation advantage. Scheduling approaches in the frequency domain can also minimize interference, and hence boost spectral efficiency.

³⁴ Source: 3G Americas member contribution.

On the uplink, however, a pure OFDMA approach results in high Peak to Average Ratio (PAR) of the signal, which compromises power efficiency and ultimately battery life. Hence, LTE uses an approach called SC-FDMA, which has some similarities with OFDMA but will have a 2 to 6 dB PAR advantage over the OFDMA method used by other technologies such as IEEE 802.16e.

LTE goals include:

- ❑ Downlink peak data rates up to 100 Mbps with 20 MHz bandwidth
- ❑ Uplink peak data rates up to 50 Mbps with 20 MHz bandwidth
- ❑ Operation in both TDD and FDD modes
- ❑ Scalable bandwidth up to 20 MHz, covering 1.25 MHz, 2.5 MHz, 5 MHz, 10 MHz, 15 MHz, and 20 MHz in the study phase. 1.6 MHz wide channels are under consideration for the unpaired frequency band, where a TDD approach will be used
- ❑ Increase spectral efficiency over Release 6 HSPA by a factor of two to four
- ❑ Reduce latency to 10 msec round-trip time between user equipment and the base station and to less than 100 msec transition time from inactive to active

The overall intent is to provide for an extremely high-performance radio-access technology that offers full vehicular speed mobility and that can readily coexist with HSPA and earlier networks. Because of scalable bandwidth, operators will be able to easily migrate their networks and users from HSPA to LTE over time.

Figure 14 shows the peak data rates possible with HSPA, HSPA+, and LTE under different types of MIMO and different spectrum bandwidth. Peak HSPA+ values are currently projected at 28 Mbps with 2X2 MIMO and 16-QAM modulation and 42 Mbps assuming 2X2 MIMO and 64-QAM modulation.

Figure 14: HSPA, HSPA+ and LTE Performance Possible Peak Data Rates³⁵

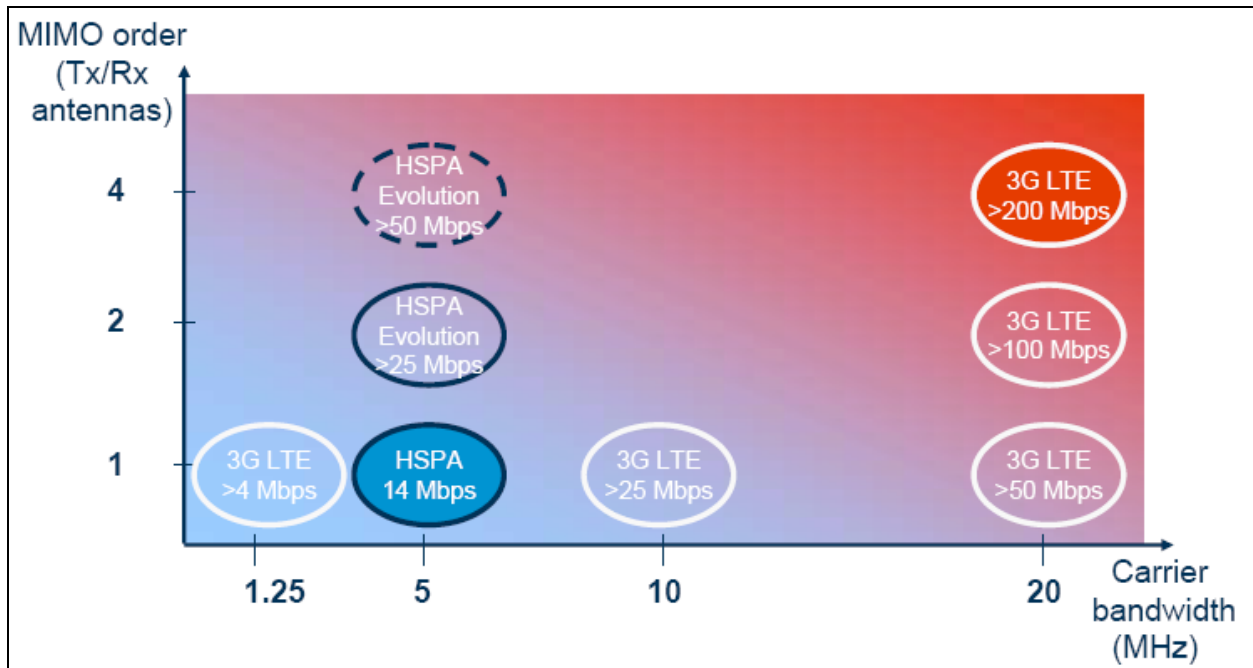

4G

LTE will address the market needs of the next decade. After that operators might deploy Fourth Generation (4G) networks using LTE technology as a foundation. There are no official standards efforts or formal definitions yet for 4G, but preliminary research is focusing on technologies capable of delivering peak rates of 1 Gbps, being fully IP based, and supporting full network agility for handovers between different types of networks, e.g., 4G to 3G to WLAN.

The International Telecommunications Union (ITU) has a framework for 4G in ITU-R Working Party 8F and has published a document, Recommendation ITU-R M.1645, entitled "Framework and overall objectives of the future development of IMT-2000 and systems beyond IMT-2000." Another ITU objective is to make innovative services available in a new globally harmonized spectrum. The high suggested 4G data rates will require channel bandwidths larger than what would be available in current spectrum.

Some companies are attempting to co-opt the term "4G" to refer to wireless systems that promise performance beyond current 3G systems. However, all these systems are on par with HSPA/HSPA+ and LTE, and their use of the term "4G" is largely inappropriate.

UMTS TDD

Most WCDMA and HSDPA deployments are based on Frequency Division Duplex, where the operator uses different radio bands for transmit and receive. An alternative approach is Time Division Duplex, where both transmit and receive functions alternate in time on

³⁵ Source: 3G Americas member contribution.

the same radio channel. 3GPP specifications include a TDD version of UMTS called UMTS TDD.

TDD does not provide any inherent advantage for voice functions, which need balanced links—namely, the same amount of capacity in both the uplink and the downlink. Many data applications, however, are asymmetric, often with the downlink consuming more bandwidth than the uplink, especially for applications such as Web browsing or multimedia downloads. A TDD radio interface can dynamically adjust the downlink-to-uplink ratio accordingly, hence balancing both forward-link and reverse-link capacity. The UMTS TDD specification also includes the capability to use joint detection in the receiver signal processing which offers improved performance. The vendor IP Wireless has commercialized UMTS TDD.

One consideration, however, relates to available spectrum. Various countries around the world, including Europe, Asia, and the Pacific region, have licensed spectrum available specifically for TDD systems. For this spectrum, UMTS TDD is a good choice. It is also a good choice in any spectrum that does not provide a duplex gap between forward and reverse links.

In the United States, there is limited spectrum specifically allocated for TDD systems³⁶. UMTS TDD is not a good choice in FDD bands as it would not be able to operate effectively in both bands, making the overall system efficiency relatively poor. One potential band for UMTS TDD is the Broadband Radio Service (BRS) band at 2.5 MHz, previously called the Multichannel Multipoint Distribution Service (MMDS) band.

As discussed in more detail in the WiMAX section on this paper, TDD systems require network synchronization and careful coordination between operators or guard bands which may be problematic in certain bands.

TD-SCDMA

Time Division-Synchronous CDMA is one of the official 3G wireless technologies being developed, mostly for deployment in China. Specified through 3GPP as a variant of the UMTS TDD System and operating with a 1.28 Megachips per second (Mcps) chip rate against 3.84 Mcps for UMTS TDD, the primary attribute of TD-SCDMA is that it is designed to support very high subscriber densities. This makes it a possible alternative for wireless local loop. TD-SCDMA uses the same core network as UMTS, and it is possible for the same core network to support both UMTS and TD-SCDMA radio-access networks.

Relative to UMTS and CDMA2000, TD-SCDMA technology is not as mature, and nor have any commercial announcements been made by operators choosing to deploy it, though trials are now underway. At this time, there are no planned deployments in any country other than China; however, TD-SCDMA could theoretically be deployed anywhere unpaired spectrum is available, such as the bands licensed for UMTS TDD, assuming appropriate resolution of regulatory issues.

³⁶ The 1910-1920 MHz band targeted unlicensed TDD systems, but has never been used.

Infrastructure and Service Advances

The previous sections of this paper emphasized advances in radio-access networks. In this section, we look at other advances that will both increase service offerings and improve the core network architecture. Specific items include IMS, MBMS, and SAE.

IP Multimedia Subsystem (IMS)

IMS is a service platform for operators to support IP multimedia applications. Potential applications include video sharing, PoC, VoIP, streaming video, interactive gaming, and so forth. IMS will enable mixed and dynamic services. For example, a user could be on a voice call but suddenly want to enable a video connection or transfer files. During an interactive chat session, the user could launch a voice call. Or while browsing the Web, the user could decide to speak to a customer-service representative.

IMS by itself does not provide all these applications. Rather, it provides a framework of application servers, subscriber databases, and gateways to make them possible. The exact services will depend on cellular operators and application developers who make these applications available to operators.

The core networking protocol used within IMS is Session Initiation Protocol (SIP), which includes the companion Session Description Protocol (SDP) used to convey configuration information such as supported voice codecs. Other protocols include Real Time Transport Protocol (RTP) and Real Time Streaming Protocol (RTSP) for transporting actual sessions. The QoS mechanisms in UMTS will be an important component of some IMS applications.

Although originally specified by 3GPP, numerous other organizations around the world are supporting IMS. These include the Internet Engineering Taskforce (IETF), which specifies key protocols such as SIP, and the Open Mobile Alliance, which specifies end-to-end service layer applications. Other organizations supporting IMS include the GSM Association (GSMA), the European Telecommunications Institute (ETSI), CableLabs, The Parlay Group, the ITU, the American National Standards Institute (ANSI), the Telecoms and Internet converged Services and Protocols for Advanced Networks (TISPAN), and the Java Community Process (JCP).

IMS is relatively independent of the radio-access network and can, and likely will, be used by other radio-access networks or even by wireline networks. Operators are already trialing IMS, and one initial application under consideration—PoC—is being specified by the Open Mobile Alliance. Other applications include picture and video sharing that occur in parallel with voice communications. Operators looking to roll out VoIP over networks could also use IMS. 3GPP initially introduced in Release 5, and has enhanced IMS in each subsequent specification release.

As shown in Figure 15, IMS operates just outside the packet core.

Figure 15: IP Multimedia Subsystem

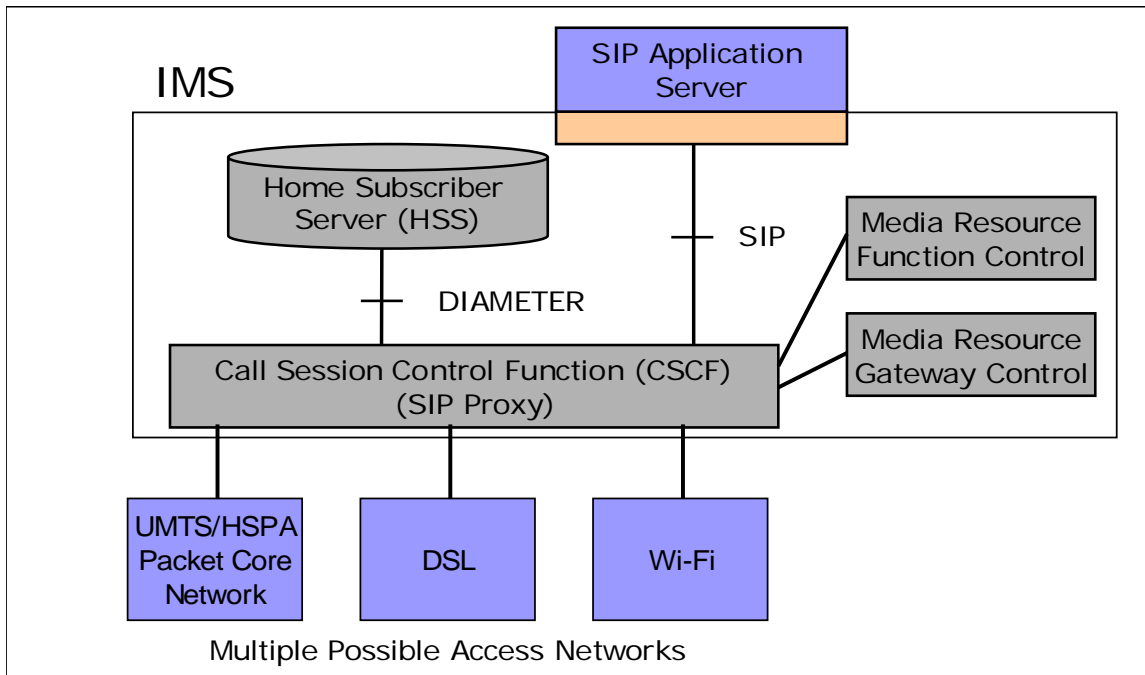

The benefits of using IMS include handling all communication in the packet domain, tighter integration with the Internet, and a lower cost infrastructure that is based on IP building blocks and is common between voice and data services. This allows operators to potentially deliver data and voice services at lower cost, thus providing these services at lower prices and further driving demand and usage.

IMS applications can reside either in the operator's network or in third-party networks, including enterprises. By managing services and applications centrally—and independently of the access network—IMS can enable network convergence. This allows operators to offer common services across 3G, Wi-Fi, and even wireline networks. Accordingly, operators around the world have committed to IMS, among them AT&T/Cingular in the United States.

Multimedia Broadcast/Multicast Service (MBMS)

An important new feature of 3GPP Release 6 is Multimedia Broadcast/Multicast Service. MBMS is a point-to-multipoint service where multiple users receive the same information using the same radio resource. This creates a much more efficient approach for delivering content, such as video programming, to which multiple users have subscriptions. In a broadcast, every subscriber unit in a service area receives the information, whereas in a multicast, only users with subscriptions receive the information. Service areas for both broadcast and multicast can span either the entire network or a specific geographical area.

System Architecture Evolution (SAE)

3GPP System Architecture Evolution is an on-going study item to develop a framework for an evolution or migration of the 3GPP system to a higher-data-rate, lower-latency, packet-optimized system that supports multiple radio access technologies. The focus of

this work will be on the packet-switched domain with the assumption that all services including voice are supported in this domain.

SAE will most likely be deployed in conjunction with LTE, but it could also be deployed for use with HSPA+, where it could provide a stepping-stone to LTE. SAE will be optimized for all services to be delivered via IP in a manner that is as efficient as possible—through minimization of latency within the system, for example. SAE will support service continuity across heterogeneous networks, which will be important for LTE operators who must simultaneously support GSM/GPRS/EDGE/UMTS/HSPA customers.

SAE will use IMS as a component and manage QoS across the whole system, which will be essential for enabling a rich set of multimedia-based services.

Figure 16 shows the SAE architecture.

Figure 16: SAE Architecture

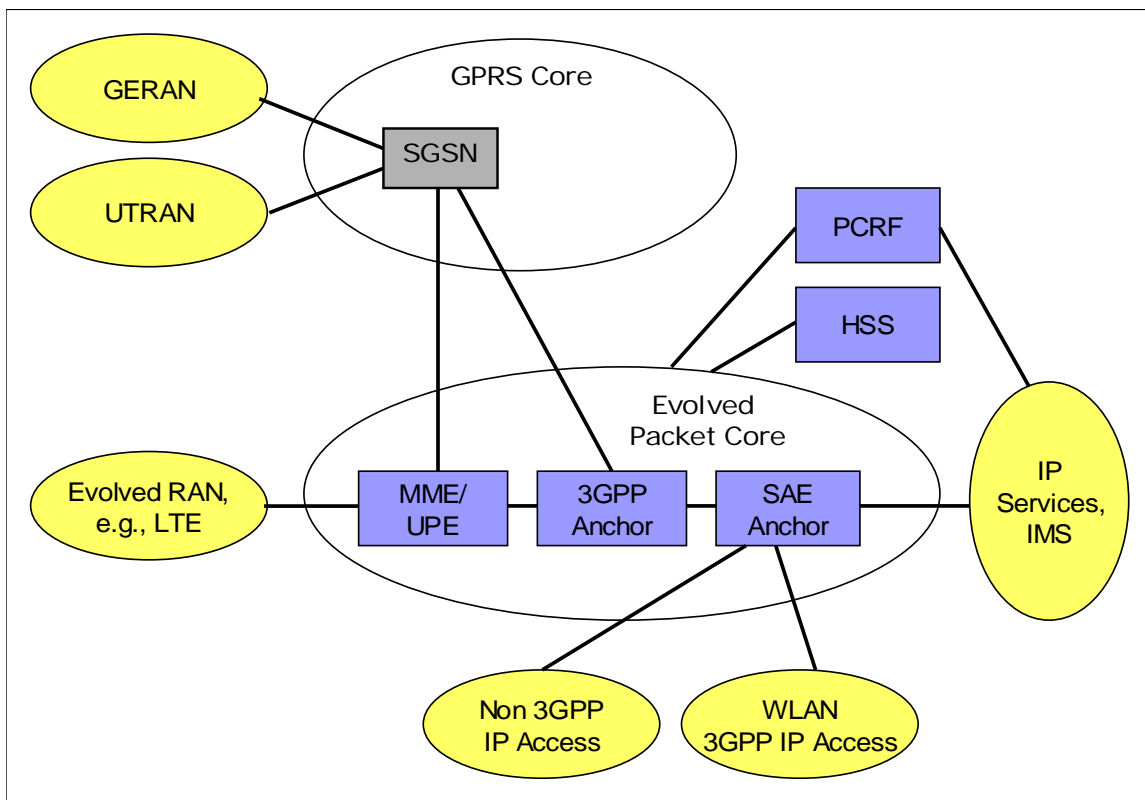

The elements of this architecture include:

- ❑ Support for legacy GSM/EDGE (GERAN) and UMTS Terrestrial Radio Access Network (UTRAN) connected via SGSN.
- ❑ Support for new radio-access networks such as LTE
- ❑ The Mobile Management Entity (MME) that supports user equipment context and identity as well as authenticates and authorizes users
- ❑ The User Plane Entity (UPE) that manages the user data path, including parameters of the IP service and routing

- ❑ The 3GPP Anchor that manages mobility between the 2G/3G access system and the LTE access system
- ❑ The SAE Anchor that manages mobility between 3GPP access systems and non-3GPP access systems, such as WLANs
- ❑ The Policy Control and Charging Rules Function (PCRF) that manages QoS aspects
- ❑ The Home Subscriber Server (HSS), which is the database of user subscription information

EDGE/HSPA/LTE Deployment and Migration

This section discusses the migration of data technologies from GSM/GPRS through to LTE. This progression happens in multiple phases, first with GPRS, then EDGE, and UMTS, followed by evolved 3G capabilities such as HSPDA, HSUPA, HSPA+, IMS, and eventually LTE.

GSM operators first enhanced their networks to support data capability through the addition of GPRS infrastructure, with the ability to use existing cell sites, transceivers, and interconnection facilities. Operators more recently deploying GSM installed GSM and GPRS simultaneously; these included AT&T Wireless (now part of Cingular), Cingular Wireless, Rogers Wireless, and Telecom Personal. Lately, operators have been upgrading their GPRS networks to EDGE, with extremely good results.

Operators are now deploying UMTS worldwide. Although UMTS involves a new radio-access network, several factors facilitate deployment. Firstly, most UMTS cell sites can be collocated in GSM cell sites enabled by multi-radio cabinets that can accommodate GSM/EDGE as well as UMTS equipment. Secondly, much of the GSM/GPRS core network can be used. While the SGSN needs to be upgraded, the mobile switching center needs only a simple upgrade and the GGSN can stay the same.

New features such as HSDPA, HSUPA, and MBMS (discussed earlier) are being designed so the same upgraded UMTS radio channel can support a mixture of terminals, including those based on 3GPP Release 99, Release 5, and Release 6. In other words, a network supporting Release 5 features (e.g., HSDPA) can support Release 99, Release 5, and Release 6 terminals (e.g., HSUPA) operating in a Release 5 mode. Alternatively, a network supporting Release 6 features can support Release 99, Release 5, and Release 6 terminals. This flexibility assures the maximum degree of forward and backward compatibility. Note also that most UMTS terminals today support GSM, facilitating use across large coverage areas and multiple networks.

Table 6 shows the rollout of EDGE/HSPA/LTE features over time.

Table 6: UMTS/LTE Feature and Capability Rollout in Networks/Terminals (Speculative Beyond 2007)

Year	Features
2006	HSPDA devices at 1.8 Mbps and 3.6 Mbps peak network rates
2007	HSDPA devices at 7.2 Mbps peak network rates HSUPA-capable networks and devices Radio techniques such as MMSE and mobile receive diversity that increase peak speeds and network capacity

Year	Features
	Initial IMS-based services (e.g., video sharing) Devices and services enabled with UMTS-QoS Evolved EDGE capabilities doubling EDGE throughput rates
2008	HSPA VoIP networks and devices enabled through Release 7, QoS, and IMS Enhanced IMS-based services (e.g., integrated voice/multimedia/presence/location) Networks and devices capable of HSPA+, including MIMO
2009	LTE introduced for next-generation throughput and latency performance Most new services implemented in the packet domain over HSPA+ and LTE

Once deployed, operators will be able to minimize the costs of managing GSM/EDGE and UMTS networks, as these networks share many of the same aspects, including:

- ❑ Packet-data architecture
- ❑ QoS architecture
- ❑ Mobility management
- ❑ Subscriber account management

Deployment of UMTS will occur in several stages, beginning with a portion of the coverage area having UMTS, progressing through continuous UMTS coverage, and then reaching highly integrated multi-radio operation. Operators will employ a similar strategy for deployment of LTE. Table 7 shows this progression.

Table 7: Network Deployment Progression of UMTS/HSPA

Deployment Stage	Characteristics
Initial UMTS deployment	Only a portion of coverage area has UMTS GSM/GPRS/EDGE provides continuous coverage UMTS provides enhanced features and capacity relief for GSM
Enhanced interworking of UMTS and GSM/EDGE and multi-radio network	Broader UMTS coverage Higher loading in UMTS Dense deployment of UMTS/HSPA, including microcells Integration of GERAN and UTRAN core equipment QoS implementation Introduction of VoIP services
Advanced core architectures	Introduction of SAE
Advanced radio interfaces	Introduction of HSPA+ Introduction of OFDMA-based 3GPP LTE

Over time, the separate GSM/EDGE access network (GERAN), UMTS access network (UTRAN), and core infrastructure elements will undergo consolidation, thus lowering total network cost and improving integrated operation of the separate access networks.

For actual users with multimode devices, the networks they access will be largely transparent. Today, most UMTS phones and modems support GSM/GPRS/EDGE.

Another important aspect of UMTS deployment (including HSPA) is the expanding number of available radio bands, as shown in Figure 17, and the corresponding support from infrastructure and mobile equipment vendors. The fundamental system design and networking protocols remain the same for each band; only the frequency-dependent portions of the radios have to change.

Figure 17: Bands for UMTS Deployment³⁷

Bandwidth	Configuration	Deployment
Up to 2600	190 MHz	New 3G band
2100	2x60 MHz	Mainstream WCDMA band
1900	2x60 MHz	PCS band in USA and Americas
1700/2100	2x45 MHz	New 3G band in USA
1800, 1700	2x75 MHz 2x30 MHz	1800 in Europe, Asia and Brazil 1700 in Japan and China with 2x30 MHz
900	2x35 MHz	Europe, Asia and Brazil
800, 850	2x25 MHz	Americas, Japan, Asia

One HSPA deployment option promoted by some vendors is a flat architecture that provides Internet access with minimal network infrastructure. In this approach, the network may not require a radio network controller and, optionally, does not need the SGSN/GGSN. Alternatively, the RNC/SGSN/GGSN nodes could be implemented in a single physical node, thereby heightening efficiency. These aspects are currently being discussed within the HSPA+ 3GPP study item.

Competing Technologies

Although GSM/GPRS/EDGE/UMTS/HSDPA networks are dominating global cellular technology deployments, other wireless technologies are being deployed that serve both wide and local areas. This section of the paper looks at the relationship between GSM/UMTS/LTE and some of these other network technologies.

³⁷ Source: 3G Americas' member company.

CDMA2000

CDMA2000, consisting principally of One Carrier Radio Transmission Technology (1xRTT) and Evolved, Data Optimized (1xEV-DO) versions, is the other major cellular technology deployed in many parts of the world. 1xRTT is currently the most widely deployed version. A number of operators have deployed or are deploying 1xEV-DO, where a radio carrier is dedicated to high-speed data functions. At the end of July 2006 there were 40 EV-DO networks available worldwide.³⁸ Evolved, Data Voice (1xEV-DV) would have allowed both voice and high-speed data on the same radio channel, but there is no longer commercial support for this technology.

EV-DO uses many of the same techniques for optimizing spectral efficiency as HSDPA, including higher order modulation, efficient scheduling, turbo-coding, and adaptive modulation and coding. For these reasons it achieves spectral efficiency that is virtually the same as HSDPA. The 1x technologies operate in the 1.25 MHz radio channels, compared to the 5 MHz channels UMTS uses. This results in lower theoretical peak rates, but average throughputs for the same level of network loading are similar. Operators quote 400 to 700 kbps typical throughput for EV-DO³⁹.

Current network versions are based on the EV-DO Rev 0 specification. EV-DO Rev A incorporates a more efficient uplink, which has spectral efficiency close to that of HSUPA. Operators are likely to make EV-DO Rev A commercially available in 2007.

One challenge for EV-DO operators is that they cannot dynamically allocate their entire spectral resources between voice and high-speed data functions. The EV-DO channel is not available for circuit-switched voice, and the 1xRTT channels offer only medium speed data. In the current stage of the market, where data only constitutes a small percentage of total network traffic, this is not a large issue. But as data usage expands, this limitation will cause suboptimal use of radio resources. Figure 18 illustrates this limitation.

³⁸ Source: www.cdg.org, July 28, 2006.

³⁹ Source: Verizon BroadbandAccess Web page, July 29, 2005; Sprint press release July 7, 2005.

Figure 18: Radio Resource Management 1xRTT/1xEV-DO versus UMTS/HSPA

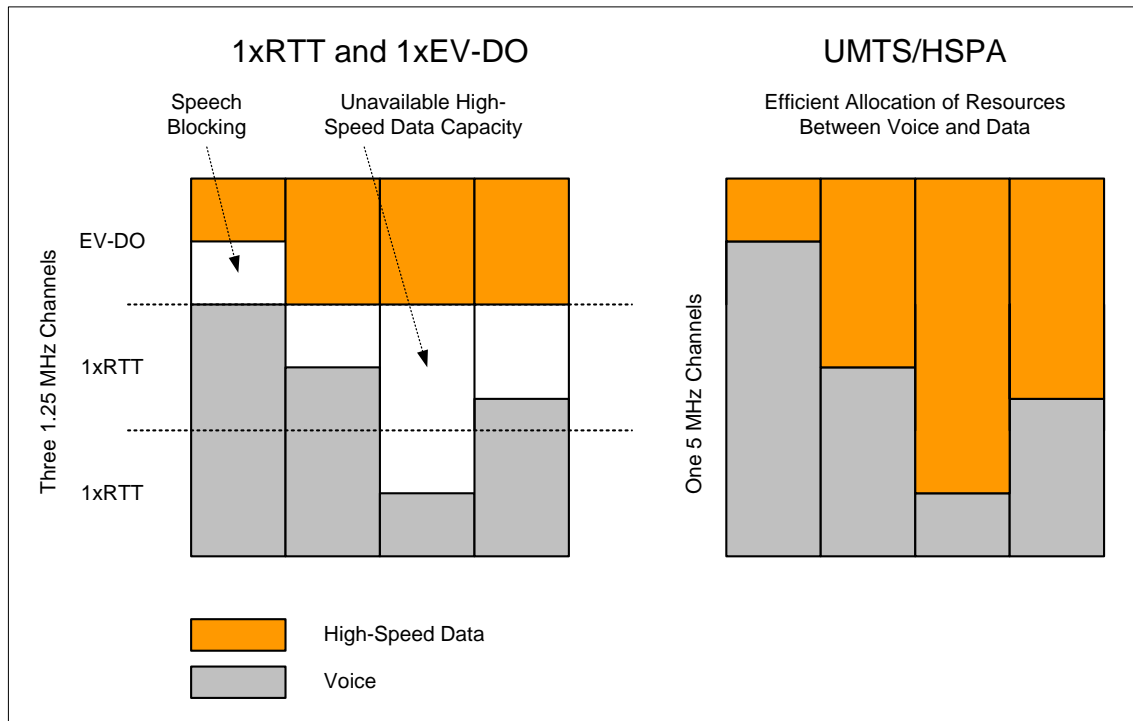

Another limitation of using a separate channel for EV-DO data services is that it currently prevents users from engaging in simultaneous voice and high-speed data services, as is possible with UMTS and HSPA. Many customers enjoy having a tethered data connection from their laptop—by using Bluetooth, for example—and being able to initiate and receive phone calls while maintaining their data sessions.

EV-DO will eventually provide voice service using VoIP protocols through EV-DO Rev A, which includes a higher speed uplink, QoS mechanisms in the network, and protocol optimizations to reduce packet overhead as well as address items such as jitter. One vendor has indicated it expects infrastructure to support VoIP on EV-DO Rev A in the 2007 to 2008 time frame, and one large EV-DO operator has indicated it could deploy VoIP in the 2008 to 2009 time frame.

Even then, however, operators will face difficult choices: How many radio channels at each base station should be made available for 1xRTT to support legacy terminals versus how many radio channels should be allocated to EV-DO. In contrast, UMTS allows both circuit-switched and packet-switched traffic to occupy the same radio channel, where the amount of power each occupies can be dynamically adjusted. This makes it simple to migrate users over time from circuit voice to packet voice.

Although advocates sometimes position Voice over IP as the “Holy Grail” of voice management, VoIP actually introduces many issues operators must manage. First and foremost, there is presently no global end-to-end VoIP system that allows voice to remain in an IP format to endpoints outside the cellular network. Such a system will inevitably become the norm at some time in the next decade. In the meantime, most VoIP calls will need to go back into the circuit-switched telephone network for termination outside the cellular network.

Beyond Rev A, 3GPP2 has defined EV-DO Rev B, which allows the combining of up to 15 1.25 MHz radio channels in 20 MHz—significantly boosting peak theoretical rates to 73.5 Mbps. More likely, an operator would combine three radio channels in 5 MHz. Such an approach does not increase overall capacity, but it does offer users high peak data rates. No operators have publicly committed to EV-DO Rev B yet. EV-DO Rev C will likely be based on an OFDMA approach.

CDMA2000 is clearly a viable and effective wireless technology and, to its credit, many of its innovations have been brought to market ahead of competing technologies. Today, however, the GSM family of technologies—including UMTS—adds more customers in one year than the entire base of CDMA2000 customers. And the GSM family has in excess of two billion subscribers—more than five times the total number of subscribers as the CDMA family of technologies.⁴⁰

WiMAX

Like GSM/UMTS, WiMAX is not a single technology; it's a family of interoperable technologies. The original specification, IEEE 802.16, was completed in 2001 and intended primarily for telecom backhaul applications in point-to-point line-of-sight configurations using spectrum above 10 GHz. This original version of IEEE 802.16 uses a radio interface based on a single-carrier waveform.

The next major step in the evolution of IEEE 802.16 occurred in 2004, with the release of the IEEE 802.16-2004 standard. It added multiple radio interfaces, including one based on OFDM-256 and one based on OFDMA. IEEE 802.16-2004 also supports point-to-multipoint communications, sub-10 GHz operation, and non-line-of-sight communications. Like the original version of the standard, operation is fixed, meaning that subscriber stations are typically immobile. Potential applications include wireless ISP service, local telephony bypass, an alternative to cable modem or DSL service, and cellular backhaul for connections from cellular base stations to operator infrastructure networks. Vendors can design equipment for either licensed or unlicensed bands.

Vendors are now delivering IEEE 802.16-2004-certified equipment. This standard does not compete directly with cellular-data and private Wi-Fi networks and can thus provide complementary services. In addition to operator-hosted access solutions, private entities such as municipal governments, universities, and corporations will be able to use this version of WiMAX in unlicensed bands (e.g., 5.8 GHz) for local connectivity, though there has been little or no development in this area.

The IEEE has completed a mobile broadband standard, IEEE 802.16e-2005, which adds mobility capabilities including support for radio operation while mobile, handovers across base stations, and handovers across operators. Unlike IEEE 802.16-2004, which operates in both licensed and unlicensed bands, IEEE 802.16e-2005 makes most sense in licensed bands. Operators could start deploying mobile WiMAX in the 2007 to 2008 time frame. Current WiMAX profiles emphasize time-division-duplex operation.

IEEE 802.16e-2005 employs many of the same mechanisms as HSPA to maximize throughput and spectral efficiency, including high-order modulation, efficient coding, dynamic modulation and coding, and HARQ. The principal difference from HSDPA is IEEE 802.16e-2005's use of OFDMA. As discussed in the "Technical Approaches (TDMA, CDMA, OFDM)" section above, OFDM provides a potential implementation advantage for wide radio channels (e.g., 10 to 20 MHz). In 5 to 10 MHz radio channels, there is no

⁴⁰ Source: Informa Telecoms & Media, World Cellular Information Service, June 2006.

evidence indicating that IEEE 802.16e-2005 will have any significant performance advantage on the downlink.

It should be noted, however, that 802.16e contains some aspects that may limit its performance, particularly in scenarios where a large number of mobile users are in a sector. The performance of the MAC layer is inefficient when scheduling large numbers of users and some aspects, such as power control of the mobile station, are provided using MAC signaling messages rather than the fast power control used in WCDMA and other technologies.

OFDM systems, including IEEE 802.16e-2005, exhibit greater orthogonality on the uplink, so IEEE 802.16e-2005 may have slightly greater uplink spectral efficiency than even HSUPA. IEEE 802.16e-2005 achieves its greatest spectral efficiency in a 1/1 reuse pattern, where each sector uses the same radio channel. However, this may introduce greater levels of other-cell interference that may introduce problems since these signals would not be orthogonal. Another deployment option for IEEE 802.16e-2005 is 1/3, where each cell site uses the same frequency band but each sector uses one of three radio channels. The 1/3 configuration is not as spectrally efficient as 1/1, but improves both cell throughput as well as higher user data rate at the cell edge.

One deployment consideration is that TDD requires network synchronization. It is not possible for one cell site to be transmitting and an adjacent cell site to be receiving at the same. Different operators in the same band either have to coordinate their networks or have guard bands to ensure they don't interfere with each other. This may introduce problems as more operators introduce networks in the same spectrum band; for example, the 2.5 GHz band in the US may be used for both TDD and FDD operation.

Although IEEE 802.16e exploits significant radio innovations, it faces challenging prospects with respect to spectrum, economies of scale, and technology. Very few operators have access to spectrum for WiMAX that would permit them to provide widespread coverage. In the United States, Clearwire and Sprint Nextel have indicated they will use mobile WiMAX technology for future network deployments.

In reference to economies of scale, GSM/UMTS/HSPA subscribers number in the billions. However, even by the end of the decade the number of WiMAX subscribers is likely to be quite low. For example, Senza Fili Consulting in a Trendsmedia Telebriefing on June 21, 2006, projected only 16 million subscribers worldwide by the end of 2010.

Finally, from a technology standpoint, mobile WiMAX on paper may be slightly more capable than today's available versions of HSPA. But by the time mobile WiMAX becomes available, it will actually have to compete against evolved HSPA systems that will offer similar capabilities and enhanced performance. And by then, LTE will not be that far from being available for deployment.

Wireless data business models must also be considered. Today's cellular networks can finance the deployment of data capabilities through a successful voice business. Building new networks for broadband wireless mandates a large amount of capacity per subscriber. Consumers who download 1 gigabyte of data each month represent a 10 times greater load on the network than a 1,000-minute a month voice user. It is not clear how easily the available revenue per subscriber will be able to finance large-scale deployment of network capacity. Although there is discussion of providing voice services over WiMAX using VoIP, mobile voice users demand extremely wide coverage, including indoor coverage. Matching the cellular footprint with WiMAX would require massive—and

unlikely—operator investments. Despite numerous attempts, no terrestrial wireless-data-only network has ever succeeded as a business⁴¹.

Flash OFDM

Fast Low-Latency Access with Seamless Handoff OFDM is a proprietary wireless networking technology developed by Flarion Technologies. Qualcomm purchased this company for a reported \$600 to \$800 million. A number of operators in Asia and Europe have trialed Flash OFDM. The first commercial network was launched in Slovakia by TM-SK using frequencies released from NMT analog service in the 450 MHz band. Another deployment commitment is in Finland, where the government has granted an operating license in the 450 MHz band for a nationwide network.

Flash OFDM is based on OFDM in the 1.25 MHz radio channels. It employs frequency hopping in the tones (subchannels), which provides frequency diversity and enables 1/1 reuse. The network is all IP based and implements voice functions using VoIP. Flarion claims typical downlink speeds of 1 to 1.5 Mbps and average uplink speeds of 300 to 500 kbps, with typical latency of less than 50 msec.

From a spectral efficiency point of view, Flash OFDM claims to achieve approximately the same downlink value as HSPA in combination with mobile receive diversity and approximately the same uplink value as HSUPA. Since the technology is proprietary, details are not available for an objective assessment. Although Flash OFDM has a time-to-market advantage in that its equipment is already available, it has major disadvantages in having support from only a small vendor base and not being an open standards-based technology.

It is not clear at this time whether Qualcomm intends to pursue deployment and development of the Flash OFDM technology or whether it intends to use the technology as a base for designing future OFDM systems.

IEEE 802.20

This IEEE standard on mobile broadband is currently on hold as a result of allegations of impropriety in the standards process. Initial contributions are similar in nature to IEEE 802.16e-2005 in that they use OFDMA, specify PHY and MAC networking layers, address flexible channelization to 20 MHz, and provide peak data rates on the order of 100 Mbps. Current contributions do not base the technology on Flash OFDM, though there are common elements. Assuming standards work resumes, efforts are at a stage where the technology could possibly be commercialized by 2008. At this time, no operator has committed to the technology.

Wi-Fi

In the local area, the IEEE 802.11 family of technologies has experienced rapid growth, mainly in private deployments. In addition, operators—including cellular operators—are offering hotspot service in public areas such as airports, fast-food restaurants, and hotels. For the most part, hotspots are complementary with cellular-data networks, as the hotspot can provide broadband services in extremely dense user areas and the cellular network can provide near-broadband services across much larger areas. Various

⁴¹ Source: Andy Seybold, January 18, 2006, commentary: "Will Data-Only Networks Ever Make Money?" <http://www.outlook4mobility.com/commentary2006/jan1806.htm>

organizations are looking at integrating wireless LAN service with GSM/UMTS data services. The GSM Association has developed recommendations for SIM-based authentication of hotspots, and 3GPP has multiple initiatives that address WLAN integration into its networks, including Unlicensed Mobile Access (UMA), IMS, and SAE.

Many cities are now deploying metro Wi-Fi systems that will provide Wi-Fi access in downtown areas. These systems are based on a mesh technology, where access points forward packets to nodes that have backhaul connections. Although some are predicting this will have an adverse effect on 3G data services, these services are more likely to be complementary in nature. This is because Wi-Fi can generally provide better application performance over limited coverage areas, whereas 3G systems can deliver access over much larger coverage areas.

Metro systems today are still quite immature and face the following challenges:

- ❑ Today's mesh systems are all proprietary. IEEE is developing a mesh networking standard—IEEE 802.16s—but this may not be ready until 2008.
- ❑ Coverage in most systems is designed to provide an outdoor signal. However, the result is that the signal does not penetrate many buildings in the coverage area, mandating repeaters to propagate the signal indoors.
- ❑ Operation is in unlicensed bands in the 2.4 GHz radio channel. Given only three relatively non-overlapping radio channels at 2.4 GHz, interference between public and private systems is inevitable.
- ❑ No proven business models exist.

Nevertheless, these networks have attracted considerable interest, and many projects are proceeding. Technical issues will likely be resolved over time, and as more devices support both 3G and Wi-Fi, users can look forward to multiple access options.

Market Fit

3G and WiMAX technologies encompass a huge range of evolving capability. But how well do these technologies actually address market needs? Table 8 matches technology capabilities with different market segments.

Table 8: Wireless Technology Fit for Market Needs

Segmentation Variable		Wireless data Market Needs	Wireless Technology Fit
Fixed versus Mobile	Fixed	Broadband capability must compete against wireline options. Continuous coverage not required.	3G not intended to compete against wireline approaches. Fixed WiMAX will compete in this area, though mostly in regions where wireline is not available. Wireline systems are evolving toward 100 Mbps, which will make it difficult for wireless systems to compete directly.

Segmentation Variable		Wireless data Market Needs	Wireless Technology Fit
	Mobile	<p>Good throughput is necessary, but it does not have to meet landline performance.</p> <p>Continuous coverage in coverage areas.</p> <p>Nationwide service offerings.</p>	<p>3G will be available in top markets with fallback to 2.5G services in other areas.</p>
Enterprise versus Consumer	Enterprise	<p>Nationwide service offerings.</p> <p>Unlimited usage service plans.</p> <p>Choice in devices, including modem cards, smartphones, and data-capable mobile phones.</p>	<p>3G technologies will provide coverage in top markets with fallback to 2.5G for other areas.</p> <p>Mobile WiMAX will potentially offer service in dense population areas.</p> <p>All technologies will likely have unlimited usage service plans.</p> <p>3G technologies will have the widest device selection and strongest economies of scale.</p>
	Consumer	<p>Wide range of feature phones with multimedia capabilities.</p>	<p>3G technologies will have the greatest selection of multimedia feature phones.</p>
Urban versus Rural	Urban	<p>High capacity to serve large numbers of subscribers.</p> <p>Broadband speeds desirable.</p>	<p>3G and mobile WiMAX will both have high capacity and the ability to deliver broadband speeds but will be limited in coverage.</p> <p>Metro Wi-Fi will be an option in some urban areas.</p>
	Rural	<p>Good coverage in low-density areas achieved through large radius cells.</p> <p>High data throughputs are a lesser priority.</p>	<p>These areas in the Americas are most likely to be served by 2.5G technologies in the near term and 3G in the longer term.</p>
Developed versus Emerging Markets	Developed	<p>Value-added services such as broadband data and wireless e-mail.</p>	<p>3G networks can provide broadband data. Mobile WiMAX networks will eventually be able to offer broadband services too.</p> <p>3G operators are likely to provide the greatest number of value-added services.</p>
	Emerging	<p>Basic telephony services supporting high-population densities. Data is a much lower priority.</p>	<p>UMTS, CDMA2000, and fixed WiMAX can all provide basic telephony services with data options.</p>
Application Type	Laptop	<p>High data throughputs.</p>	<p>3G can deliver high data throughputs and is available in PC Card and embedded formats.</p> <p>Mobile WiMAX will eventually be able to do the same in some areas.</p>
	Smartphone	<p>Medium data throughputs and wide coverage areas.</p>	<p>2.5/3G is the best choice because of data support and wide coverage areas.</p>

Segmentation Variable		Wireless data Market Needs	Wireless Technology Fit
	Feature Phone for Multimedia	High data throughputs and wide coverage areas.	3G is the best choice because of data support and wide coverage areas.

Comparison of Wireless Technologies

This section of the paper compares the different wireless technologies, looking at throughput, latency, spectral efficiency, and market position. Finally, the paper presents a table that summarizes the competitive position of the different technologies across multiple dimensions.

Data Throughput

Data throughput is an important metric for quantifying network throughput performance. Unfortunately, how various organizations quote throughput varies tremendously, which often results in misleading claims. The intent of this paper is to realistically represent the capabilities of these technologies.

One method of representing a technology's throughput is what people call "peak throughput" or "peak network speed." This refers to the fastest possible transmission over the radio link and is generally based on the highest order modulation available and the least amount of coding (error correction) overhead. It is also usually quoted at layer 2 of the radio link. Because of protocol overhead, application throughput may be 10 to 20 percent lower (or more) than this figure. Even if the radio network can deliver this speed, other aspects of the network—such as the backhaul from base station to operator infrastructure network—can often constrain throughput rates.

Another method is to disclose throughputs actually measured in deployed networks with applications such as File Transfer Protocol (FTP) under favorable conditions, which assumes light network loading (as low as one active data user in the cell sector) and favorable signal propagation. This number is useful because it demonstrates the high-end actual capability of the technology. This paper refers to this rate as the "peak user-achievable rate." However, average rates are lower than this peak, and no precise guideline can be provided. Unless the network is experiencing congestion, the majority of users should experience throughput rates higher than one half of the peak achievable rate.

Table 9 presents the technologies in terms of peak network throughput rates and peak user-achievable rates (under favorable conditions). It omits values that are not yet known, such as those associated with future technologies.

Table 9: Throughput Performance of Different Wireless Technologies

	Downlink		Uplink	
	Peak Network Speed	Peak Achievable User Rate	Peak Network Speed	Peak Achievable User Rate
GPRS (CS1-2, type 2 MS)⁴²	107.2 kbps		107.2 kbps	
GPRS (CS1-2, type 1 MS)⁴³	53.6 kbps	40 kbps	53.6 kbps	40 kbps
GPRS (CS1-4, type 2 MS)⁴⁴	171.2 kbps		171.2 kbps	
GPRS (CS1-4, type 1 MS)	85.6 kbps		85.6 kbps	
EDGE (type 2 MS)	473.6 kbps	400 kbps	473.6 kbps	400 kbps
EDGE (type 1 MS)	236.8 kbps	200 kbps	236.8 kbps	200 kbps
Evolved EDGE (type 1 MS)⁴⁵	652.8 kbps	500 kbps	326.4 kbps ⁴⁶	250 kbps
Evolved EDGE (type 2 MS)⁴⁷	1305.6 kbps	1.0 Mbps	652.8 kbps	500 kbps
UMTS WCDMA Rel'99 (Theoretical)	2.048 Mbps		768 kbps	
UMTS WCDMA Rel'99 (Practical Terminal)	384 kbps	350 kbps	384 kbps	350 kbps
HSDPA Initial Devices	1.8 Mbps	> 1 Mbps	384 kbps	350 kbps
HSDPA Current Devices	3.6 Mbps	> 2 Mbps ⁴⁸	384 kbps	350 kbps
HSDPA Future Devices	7.2 Mbps	> 3 Mbps	384 kbps	350 kbps
HSDPA Theoretical Peak	14.4 Mbps		5.76 Mbps	
HSPA⁴⁹ Initial Implementation	7.2 Mbps	> 4 Mbps	1.46 Mbps	1 Mbps

⁴² CS1-2 refers to coding schemes 1 and 2, available on most GPRS networks today. Type 2 refers to a mobile station that can send or receive on up to eight timeslots in one radio channel.

⁴³ Type 1 refers to a mobile station that can send or receive on four timeslots in one radio channel.

⁴⁴ CS1-4 refers to coding schemes 1 to 4.

⁴⁵ A type 1 evolved EDGE MS can receive on up to eight timeslots using two radio channels and can transmit on up to four timeslots in one radio channel using 16 QAM modulation with turbo coding.

⁴⁶ 473.6 kbps peak rate projected with implementation of higher symbol rates.

⁴⁷ A type 2-evolved EDGE MS can receive on up to 16 times slots using two radio channels and can transmit on up to eight timeslots in one radio channel using 16 QAM modulation with turbo coding.

⁴⁸ 2 Mbps requires supporting network

⁴⁹ High Speed Packet Access (HSPA) consists of systems supporting both High Speed Downlink Packet Access (HSDPA) and High Speed Uplink Packet Access (HSUPA).

	Downlink		Uplink	
	Peak Network Speed	Peak Achievable User Rate	Peak Network Speed	Peak Achievable User Rate
HSPA Future Implementation	7.2 Mbps		5.76 Mbps	
HSPA Theoretical Peak	14.4 Mbps		5.76 Mbps	
HSPA+ (2X2 MIMO, 16-QAM)	28 Mbps ⁵⁰		11.5 Mbps	
3GPP LTE Targets (in 20 MHz bandwidth)	100 Mbps		50 Mbps	
CDMA2000 1XRTT	153 kbps	130 kbps	153 kbps	130 kbps
CDMA2000 1XRTT Theoretical Peak	307 kbps		307 kbps	
CDMA2000 EV-DO Rev 0	2.4 Mbps	> 1 Mbps	153 kbps	150 kbps
CDMA2000 EV-DO Rev 0 Theoretical Peak	2.4 Mbps		307 kbps	
CDMA2000 EV-DO Rev A expected and theoretical	3.1 Mbps	> 1 Mbps	1.8 Mbps	900 kbps
CDMA2000 EV-DO Rev B expected (3 radio channels)	9.3 Mbps		5.4 Mbps	
CDMA2000 EV-DO Rev B Theoretical (15 radio channels)	73.5 Mbps		27 Mbps	
CDMA2000 EV-DO Rev C Goals	100 Mbps		50 Mbps	
802.16e WiMAX expected phase 1 (10 MHz TDD DL/UL=3, 1X2 SIMO)	23 Mbps		4 Mbps	
802.16e WiMAX expected phase 2 (10 MHz TDD, DL/UL=3, 2x2 MIMO)	46 Mbps		4 Mbps	

Yet another approach to representing a technology's throughput is to quote an average or typical speed for users that takes more factors into account, such as the operator's actual network configuration, backhaul constraints, and a higher though generally unspecified level of loading. U.S. operators have quoted typical throughput rates, but this is less common in other countries.

Rysavy Research's 2002 paper for 3G Americas on wireless data anticipated EDGE average performance of 110 to 130 kbps and UMTS average performance of 200 to 300 kbps. Actual results from operator and vendor field trials matched the predicted results,

⁵⁰ 28 Mbps achievable in Release 7. 42 Mbps possible with implementation of 64-QAM.

validating the methodology used to predict performance. In the 2004 and 2005 versions of the paper, the 550 to 800 kbps throughput performance of initial HSDPA devices has also materialized as fairly accurate.

In the United States, Cingular Wireless quotes typical HSDPA throughput rates of 400 to 700 kbps. Sprint Nextel and Verizon quote typical EV-DO Rev 0 rates of 400 to 700 kbps.

HSDPA Throughput in Representative Scenarios

It is instructive to look at actual HSDPA throughput in a commercial network. The following three figures show test results from a network in Europe that was lightly loaded with respect to data but supporting voice traffic. Neither the median value nor the actual histogram should be taken as absolute. Rather, the distribution shows representative HSDPA performance. Actual performance will vary by network, geography, network load, devices, and so forth. However, distributions will generally have these kinds of profiles.

Under a favorable signal condition⁵¹ with a 1.8 Mbps device⁵², the median bit rate measured was 1.48 Mbps. The blue line in Figure 19 is the Cumulative Distribution Function (CDF), which shows the probability of throughput being at least that high.

Figure 19: Histogram of HSDPA Throughput Under Favorable Radio Conditions⁵³

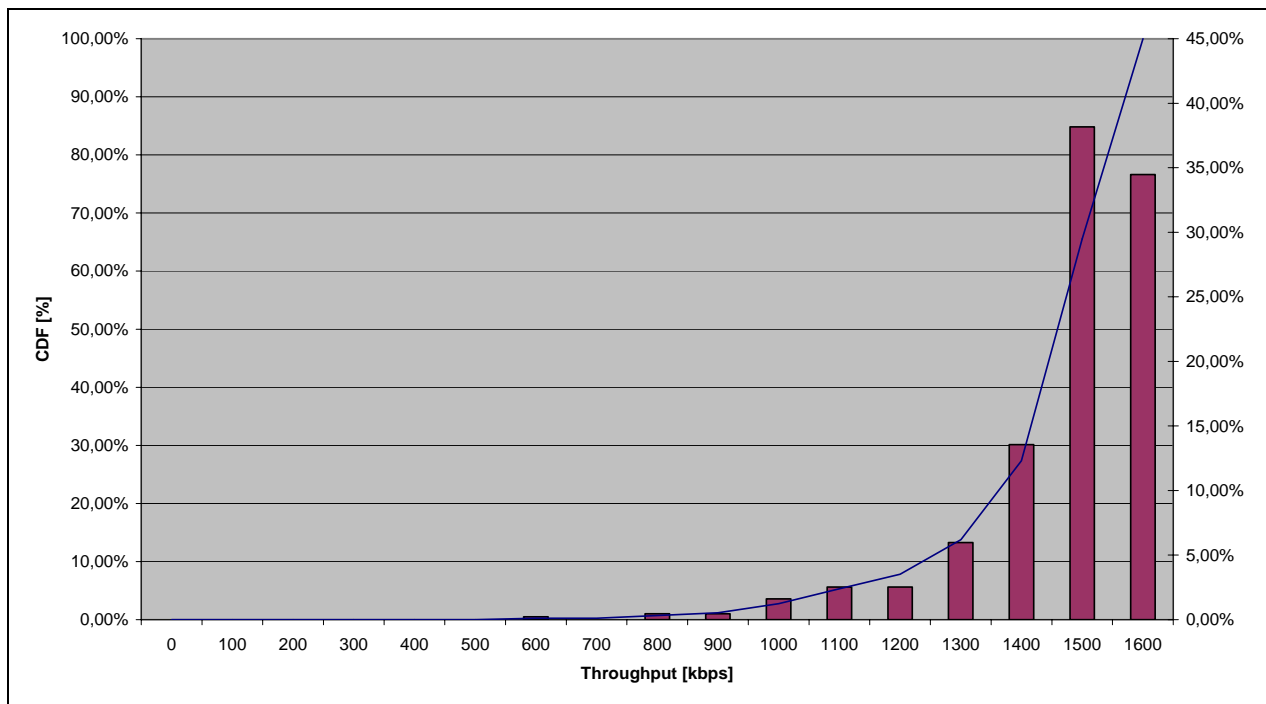

⁵¹ Received signal code power (RSCP) was -70 dBm and the Signal Energy per chip over Noise Power Spectral Density (EC/NO) was -4.5 dB.

⁵² Peak network rate of 1.8 Mbps at layer 2.

⁵³ Source: 3G Americas member company contribution.

Figure 20 shows the distribution of throughput under unfavorable radio conditions⁵⁴. Though measured values were lower than under good radio conditions, the median rate was still quite high, at 930 kbps.

Figure 20: Histogram of HSDPA Throughput Under Unfavorable Radio Conditions⁵⁵

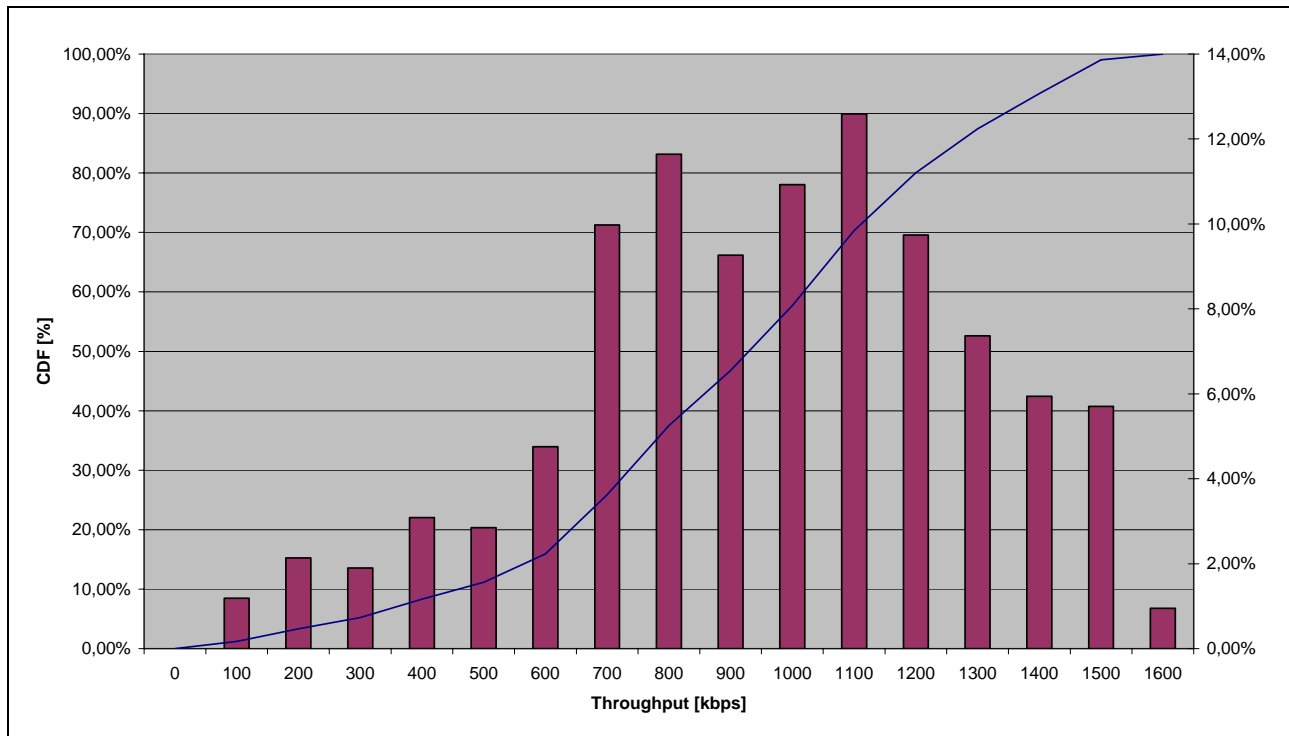

Figure 21 shows the distribution of throughput measured with favorable radio conditions⁵⁶ while driving through a coverage area. Though lower than operation when stationary, the median throughput rate was still 1.2 Mbps.

It is interesting to note how the range of data rates experienced by the user increases when moving from an area with favorable conditions to areas with less favorable conditions, or in a mobile environment.

⁵⁴ Received signal code power (RSCP) was -110 dBm and the Signal Energy per chip over Noise Power Spectral Density (EC/NO) was -13 dB.

⁵⁵ Source: 3G Americas member company contribution.

⁵⁶ Received signal code power (RSCP) was -70 dBm and the Signal Energy per chip over Noise Power Spectral Density (EC/NO) was -5.5 dB.

Figure 21: Histogram of HSDPA Throughput Under Favorable Radio Conditions While Mobile⁵⁷

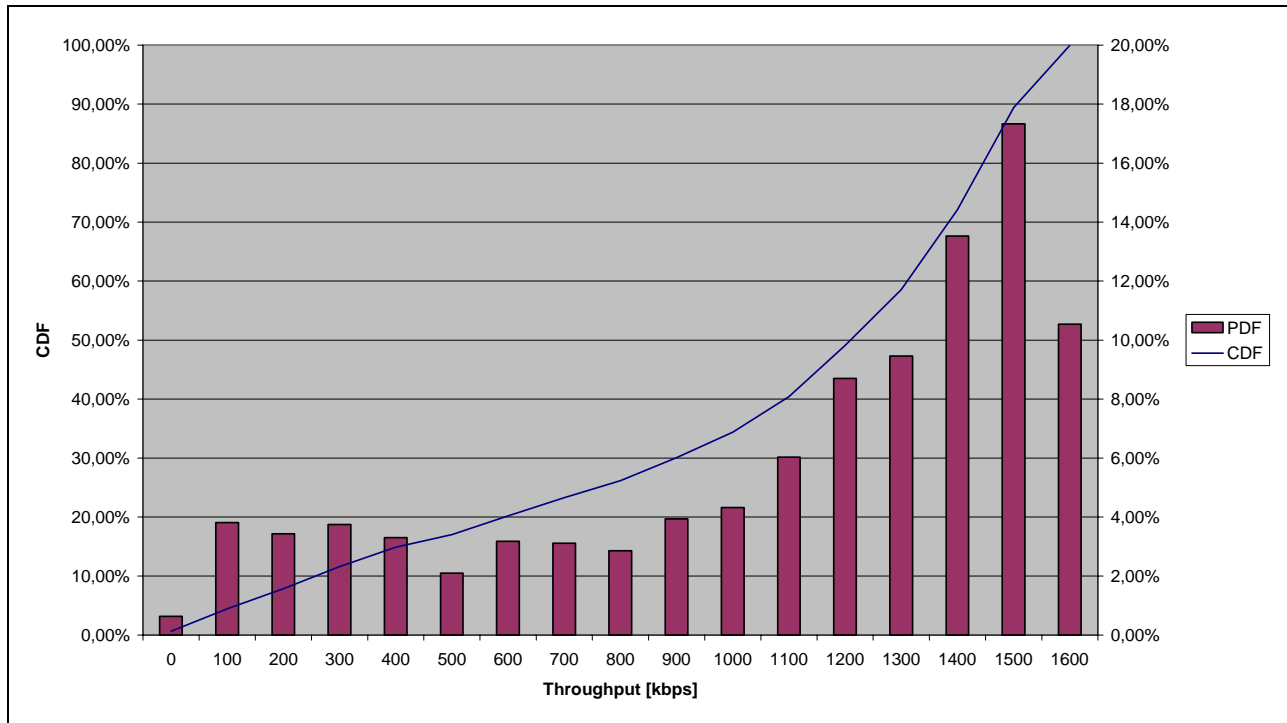

Release 99 and HSUPA Uplink Performance

HSUPA will dramatically increase uplink throughputs over Release 99. However, even Release 99 networks have seen significant uplink increases. Many networks were initially deployed with a 64 kbps uplink rate. Later, this increased to 128 kbps. Now, operators are increasing speeds further, to 384 kbps peak rates, with peak user-achievable rates of 350 kbps.

Figure 22 shows the average throughputs when using a Release 99 128 kbps Bearer, or a Release 99 384 kbps Bearer, and when using HSUPA in a system limited to 1.46 Mbps maximum throughput. It plots throughputs versus cell range and shows operation at 1,900 MHz, in a suburban area with 10 simultaneous Voice users. The cell range is only one of the dimensions that can affect the average throughput. Similarly to HSDPA, the fast scheduling and ARQ used in HSUPA allow the system to adjust the instantaneous data rate to the instantaneous propagation and interference conditions faced by the Terminal. Figure 22 shows that average throughput higher than 500kbps are achievable at 1900 MHz in a sub-urban area for a typical inter-site distance of 2.5 km (1.7 km max cell range), but will be lower for higher inter-site distances.

⁵⁷ Source: 3G Americas member company contribution.

Figure 22: Average Release 99 Uplink and HSUPA Throughput⁵⁸

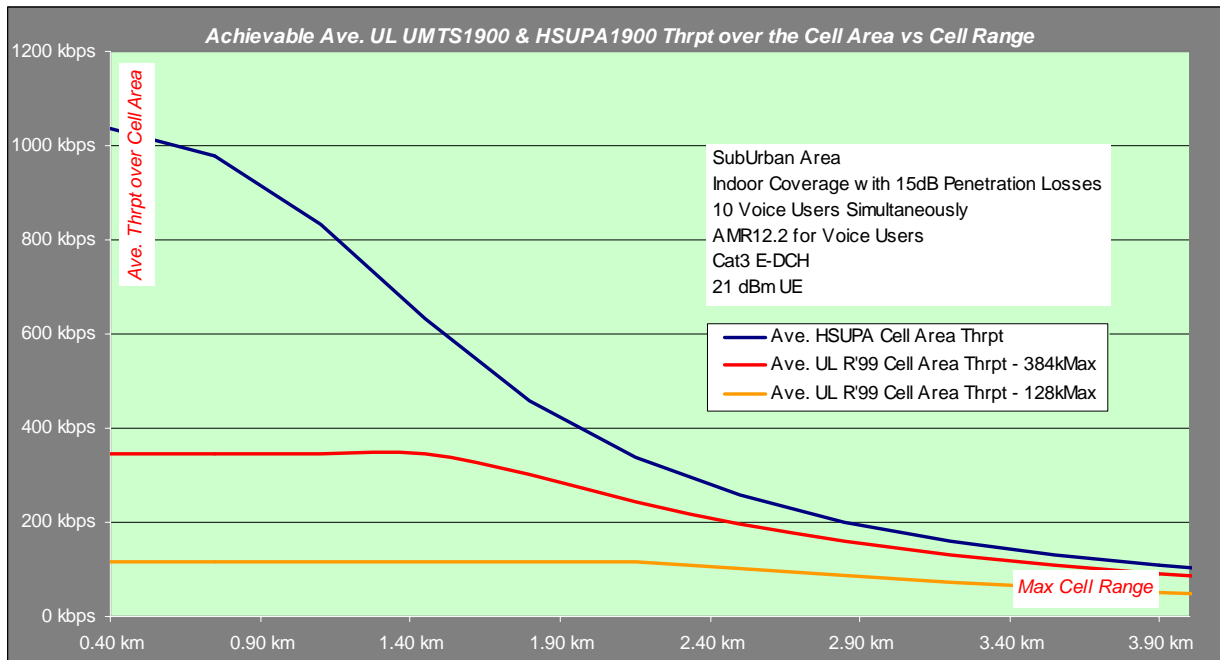

Latency

Just as important as throughput is network latency: defined as the round-trip time it takes data to traverse the network. Each successive data technology from GPRS forward reduces latency, with HSDPA having latency as low as 70 msec. HSUPA brings latency down even further, as will 3GPP LTE. Ongoing improvements in each technology mean all these values will go down as vendors and operators fine-tune their systems. Figure 23 shows the latency of different 3GPP technologies.

⁵⁸ Source: 3G Americas member company contribution.

Figure 23: Latency of Different Technologies⁵⁹

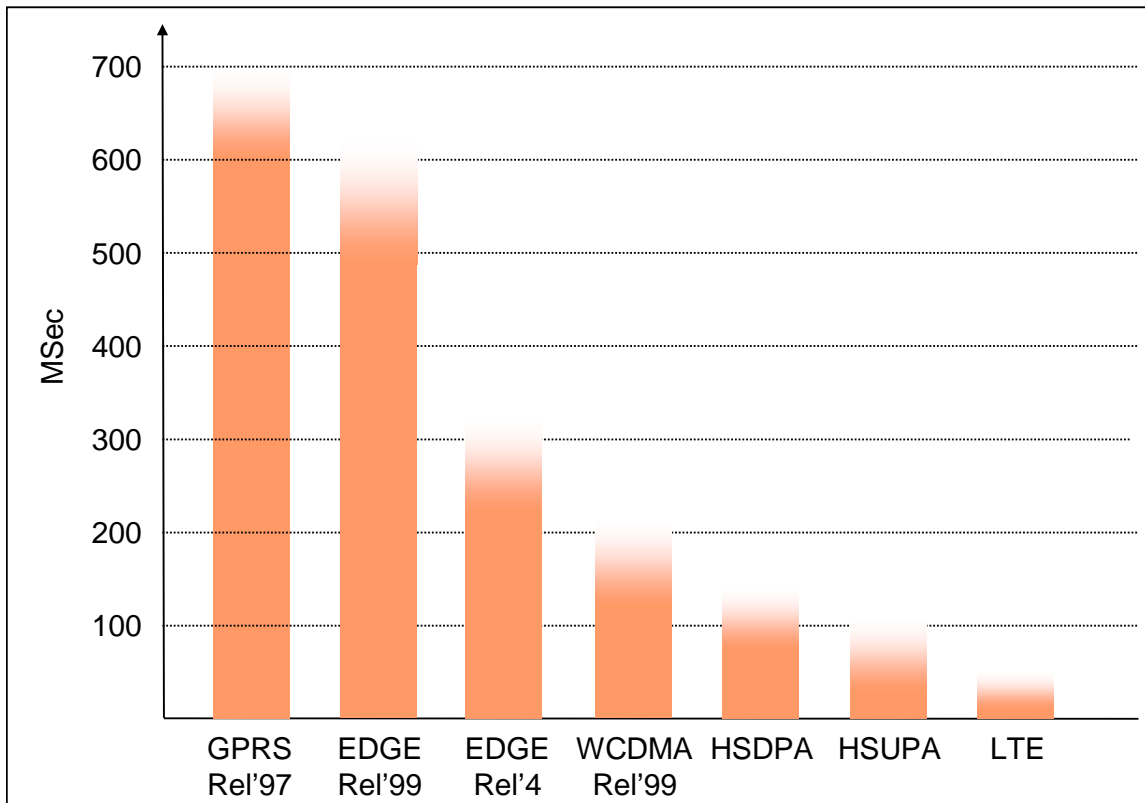

The values shown above reflect measurements in commercial networks. Some vendors have reported significantly lower values in networks using their equipment, such as 150 msec for EDGE and 70 msec for HSDPA.

Spectral Efficiency

To better understand the reasons for deploying the different data technologies and to better predict the evolution of capability, it is useful to examine spectral efficiency. The evolution of data services will be characterized by an increasing number of users with ever-higher bandwidth demands. As the wireless data market grows, deploying wireless technologies with high spectral efficiency will be of paramount importance. Keeping all other things equal, such as frequency band, amount of spectrum, and cell site spacing, an increase in spectral efficiency translates to a proportional increase in the number of users supported at the same load per user—or, for the same number of users, an increase in throughput available to each user. Delivering broadband services to large numbers of users can be best achieved with high spectral efficiency systems, especially since the only other alternatives are using more spectrum or deploying more cell sites.

Increased spectral efficiency comes at a price, however. It generally implies greater complexity for both user and base station equipment. Complexity can arise from increased numbers of calculations performed to process signals or from additional radio

⁵⁹ Source: 3G Americas' member companies. Measured between subscriber unit and Gi interface, just external to wireless network. Does not include Internet latency. Note that there is some variation in latency based on network configuration and operating conditions.

components. Hence, operators and vendors must balance market needs against network and equipment cost.

The roadmap for the EDGE/HSPA/LTE family of technologies provides a wide portfolio of options to increase spectral efficiency. The exact timing for deploying these options is difficult to predict because much will depend on the growth of the wireless data market and what types of applications become popular.

When determining the best area on which to focus future technology enhancements, it is interesting to note that HSDPA, 1xEV-DO, and IEEE 802.16e-2005 all have highly optimized link, i.e., physical layers. In fact, as shown in Figure 24, the link layer performance of these technologies is approaching the theoretical limits as defined by the Shannon bound. (The Shannon bound is a theoretical limit to the information transfer rate [per unit bandwidth] that can be supported by any communications link. The bound is a function of the Signal to Noise Ratio [SNR] of the communications link.) Figure 24 also shows that HSDPA, 1xEV-DO, and IEEE 802.16e-2005 are all within 2 to 3 dB of the Shannon bound, indicating that there is not much room for improvement from a link layer perspective.

Figure 24: Performance Relative to Theoretical Limits for HSDPA, EV-DO, and IEEE 802.16e-2005⁶⁰

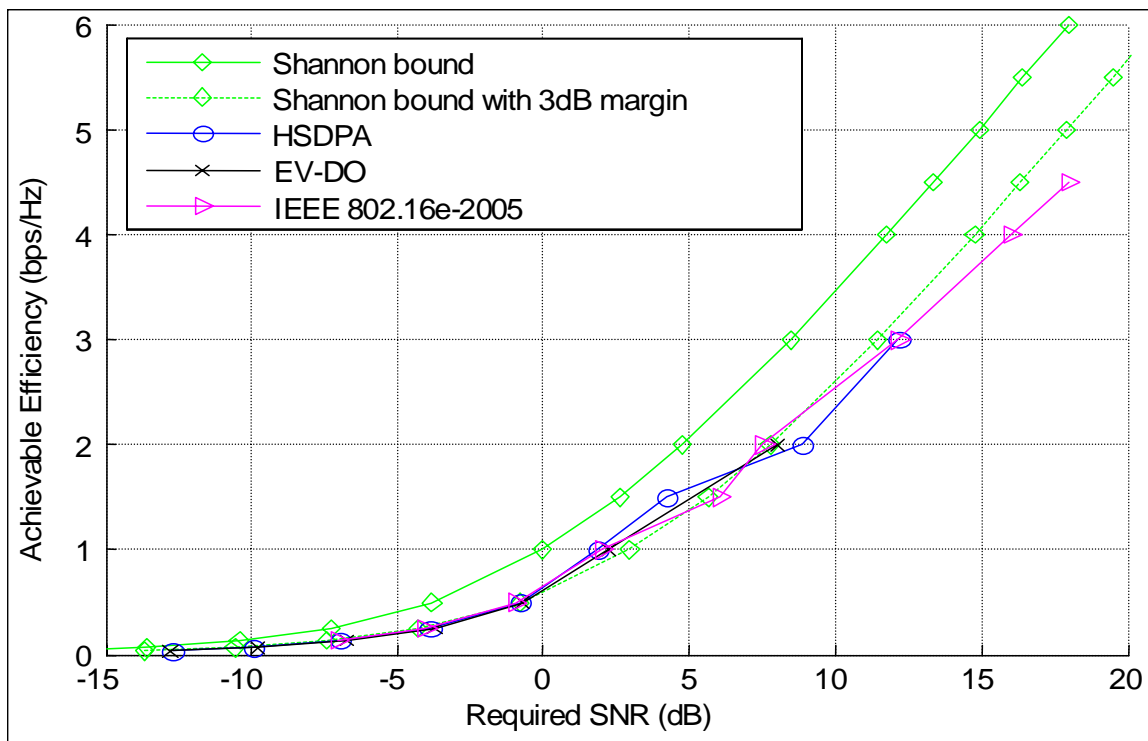

Although the curves in Figure 25 apply to an Additive White Gaussian Noise Channel (AWGN), if the channel is slowly varying and the effect of frequency selectivity can be overcome through either an equalizer in HSDPA or OFDM, then the channel can be known almost perfectly and the effects of fading and non-AWGN interference can be ignored, thus justifying the AWGN assumption. As the speed of the mobile station

⁶⁰ Source: 3G Americas' member company.

increases and the channel estimation becomes less accurate, additional margin is needed, but this additional margin would impact the different standards fairly equally.

The curves also demonstrate that the focus of future technology enhancements should be on improving system performance aspects that improve and maximize the experienced SNRs in the system rather than investigating new air interfaces that attempt to improve the link layer performance. Examples of technologies that improve SNR in the system are those that minimize interference through intelligent antennas or interference coordination between sectors and cells. Note that MIMO techniques using spatial multiplexing to potentially increase the overall information transfer rate by a factor proportional to the number of transmit or receive antennas do not violate the Shannon bound since the per antenna transfer rate (i.e., the per communications link transfer rate) is still limited by the Shannon bound.

This situation suggests that arguments over which wireless technology outperforms another are largely irrelevant, as all the technologies offer largely comparable performance at the physical layer. Users should concentrate instead on other factors, such as availability, pricing, coverage, roaming, and devices.

Figure 25 compares the spectral efficiency of different wireless technologies based on a consensus view of 3G Americas contributors to this paper. It shows the continuing evolution of the capabilities of all the technologies.

Figure 25: Comparison of Downlink Spectral Efficiency⁶¹

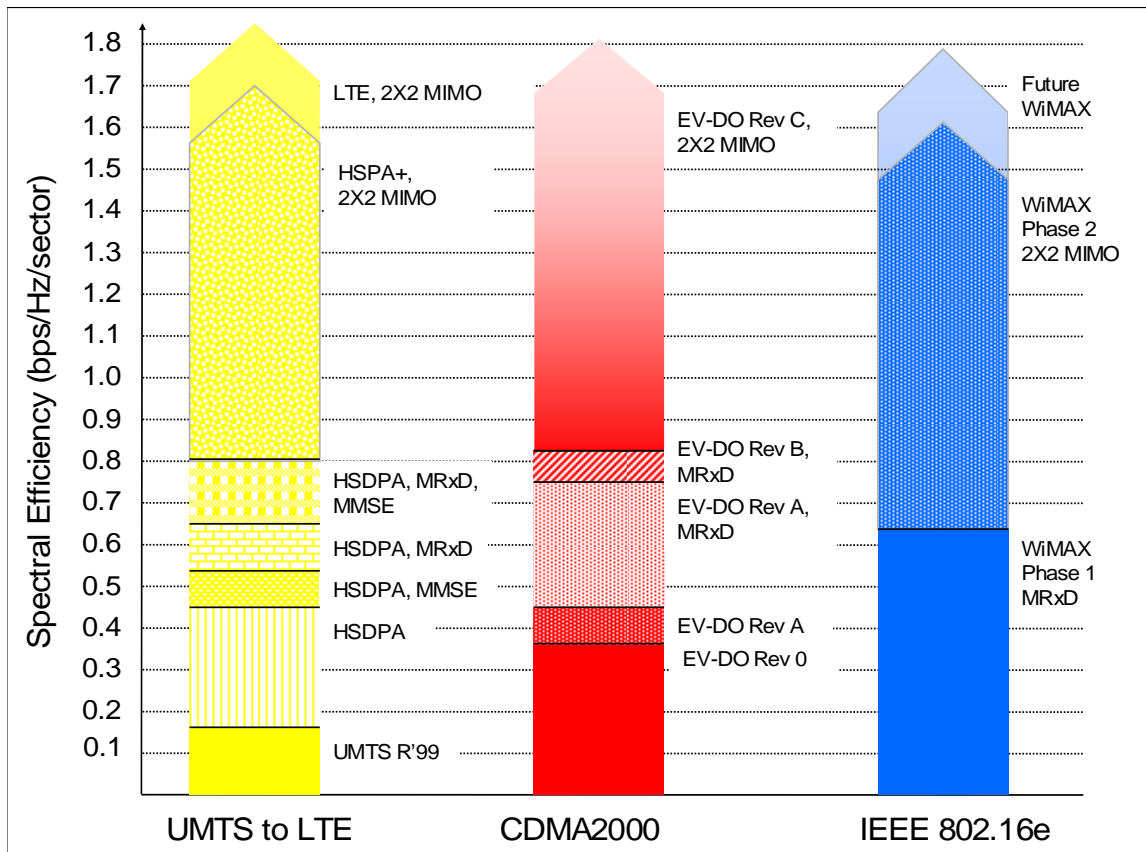

⁶¹ Source: Joint analysis by 3G Americas' members. 5+5 MHz for UMTS/HSPA/LTE and CDMA2000, and 10 MHz DL/UL=3:1 TDD for WiMAX.

Relative to WCDMA Release 99, HSDPA increases capacity by almost a factor of three. Minimum Mean Square Error (MMSE) equalization will further increase capacity by a factor of approximately 20 percent, and Mobile Receive Diversity (MRxD) will boost capacity by a factor of approximately 50 percent. MMSE and MRxD can be used jointly, producing almost a doubling of HSDPA spectral efficiency. Significant additional gains are available in HSPA+ with MIMO.

Beyond HSDPA, 3GPP LTE will also result in further gains in spectral efficiency, with spectral efficiency two to three times that of Release 6 HSPA. 3GPP standards bodies are still finalizing HSPA+ details, but if all optimizations under consideration are implemented, HSPA+ spectral efficiency could reach within 10% of LTE spectral efficiency in 5 MHz channels.

Similar gains are available for CDMA2000. Mobile WiMAX also experiences gains in spectral efficiency as various optimizations, such as MRxD and MIMO, are applied.

The main reason that HSPA+ with MIMO is shown as spectrally more efficient than WiMAX with MIMO is because HSPA supports incremental-redundancy HARQ while the initial WiMAX profiles support only Chase Combining HARQ. Another reason is that WiMAX has larger control overhead in the downlink than HSPA because the uplink in WiMAX is fully scheduled. This is required for OFDMA technology because the mobiles need to be scheduled to avoid two mobiles transmitting on the same tones simultaneously. An uplink MAP zone in the downlink channel does this scheduling.

Conversely, HSUPA can use autonomous transmission on the uplink. Hence, there is no downlink overhead required to schedule the uplink. This does lead to a disadvantage for HSUPA in the uplink when compared to WiMAX, as Figure 26 shows, because the HSUPA uplink is not orthogonal. But it does provide an advantage of lower downlink control overhead for HSPA relative to WiMAX. It also helps to mitigate other-cell interference which may become a problem when WiMAX is deployed.

An important conclusion of this comparison is that all the major wireless technologies achieve comparable spectral efficiency through the use of comparable radio techniques.

Figure 26 compares the uplink spectral efficiency of the different systems.

Figure 26: Comparison of Uplink Spectral Efficiency⁶²

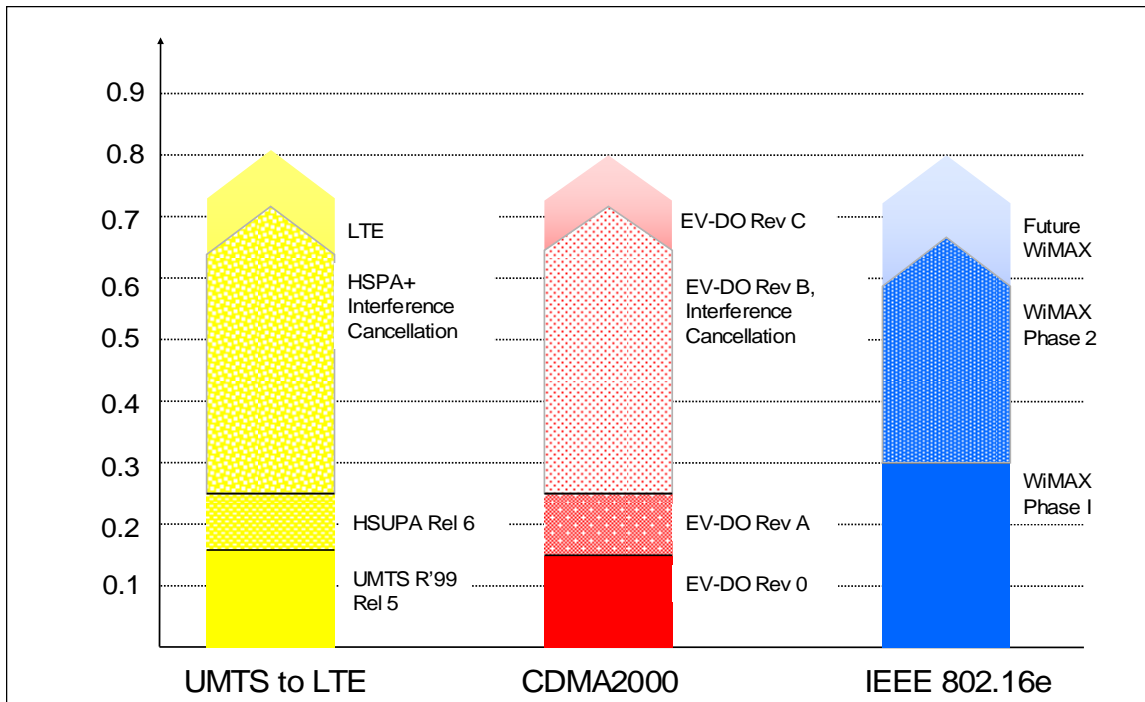

HSUPA significantly increases uplink capacity, as does Rev A of 1xEV-DO, compared to Rev 0. OFDM-based systems can exhibit improved uplink capacity relative to CDMA technologies but this depends on factors such as the scheduling efficiency and the exact deployment scenario. 3G Americas members anticipate that CDMA can match OFDM systems via interference cancellation.

Figure 26 shows WiMAX uplink spectral efficiency to be lower than 3GPP and 3GPP2 technologies employing interference cancellation. This is due to the high pilot overhead in IEEE 802.16e, as high as 33% of tones. With the optional more efficient pilot structure implemented, it is likely that IEEE 802.16e uplink spectral efficiency will be on par.

Opportunities to improve voice capacity using VoIP over HSPA channels will arise. Depending on the specific enhancements implemented, voice capacity could double over existing circuit-switched systems. It should be noted, however, that the gains are not related specifically to the use of VoIP; rather, gains relate to advances in radio techniques applied to the data channels. Many of these same advances could also be applied to current circuit-switched modes. However, other benefits of VoIP are driving the migration to packet voice, including a consolidated IP core network for operators and sophisticated multimedia applications for users.

Figure 27 compares voice spectral efficiency. It assumes a round-robin type of scheduler, as opposed to a proportional-fair scheduler that is normally used for asynchronous data.

⁶² Source: Joint analysis by 3G Americas' members.

Figure 27: Comparison of Voice Spectral Efficiency⁶³

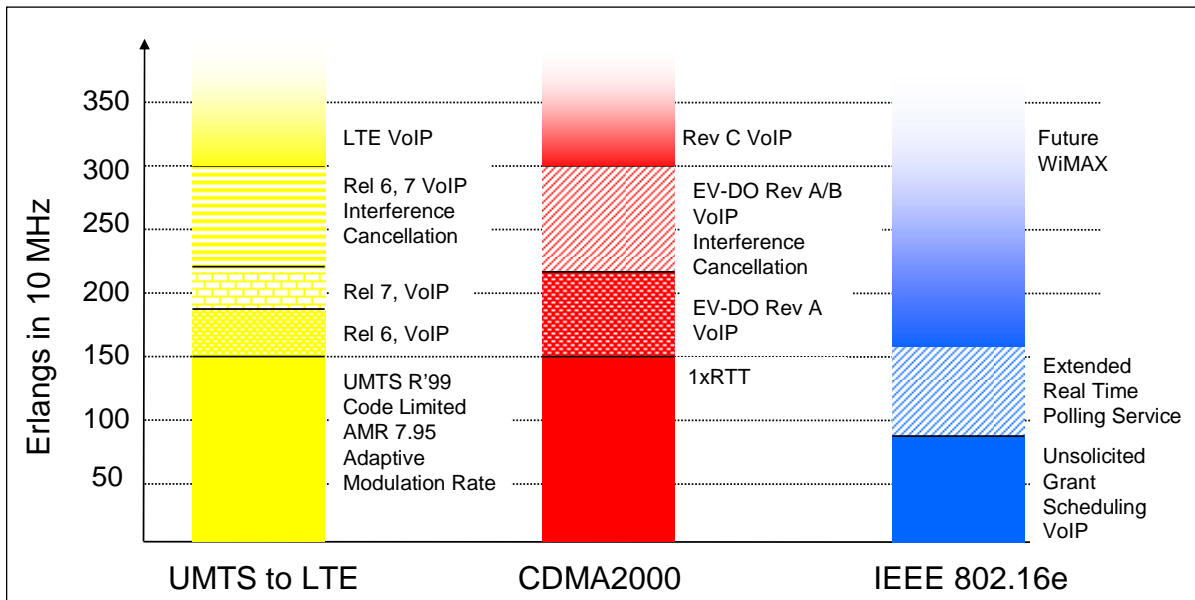

Remember that for practical VoIP deployments, it is highly beneficial to be able to combine circuit-switched and packet-switched voice on the same radio carrier, which is only possible with WCDMA/HSPA.

Initial versions of VoIP with IEEE 802.16e are not expected to be near as spectrally efficient as current circuit-switched approaches with CDMA-based systems.

Power Consumption Comparison

Mobile consumers have become accustomed to the size, weight, cost and battery life of voice-only devices. New product offerings will be measured against these existing metrics, regardless of what new features they offer. Any noticeable regression from the current voice-only level could impact adoption on new data-centric devices. A mobile device that provides high speed data requires greater computing power and greater RF power consumption, resulting in shorter battery life.

In that respect, every technology has specific power requirements impacting battery life. Improvements in battery technology will enhance all radio access technologies, so the differences between how current technologies use battery power are likely to persist for some time.

Figure 28 shows a comparison of the peak mobile power dissipation while transmitting for the different technologies. The values include both digital processing and RF elements.

⁶³ Source: Joint analysis by 3G Americas' members.

Figure 28: Comparison of Power Consumption of Different Technologies⁶⁴

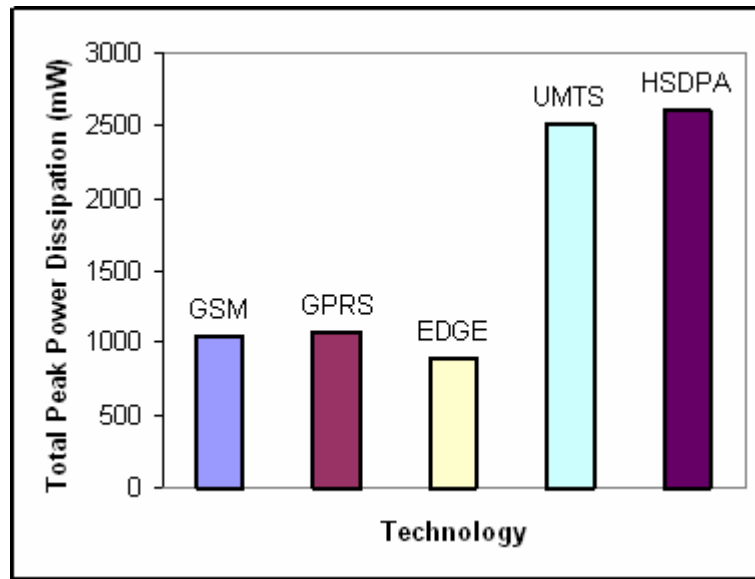

The contribution to the power consumption from the RF circuitry from receiving is much lower (typically 80 to 100 mW) and varies less across the different wireless technologies.

Cost and Volume Comparison

So far, we have compared technologies on the basis of technical capability and demonstrated that many of the different wireless technologies have similar technical attributes. This is for the simple reason that they employ many of the same approaches.

However, there is a point of comparison where the differences between the technologies diverge tremendously; namely, the difference in volume involved, including subscribers and amount of infrastructure. This translates to dramatically reduced costs for the highest volume solutions, specifically GSM/UMTS. Based on projections and numbers already presented in this paper, 3G subscribers on UMTS will number in the many hundreds of millions by the end of this decade, whereas emerging wireless technologies such as IEEE 802.16e-2005 will number in the tens of millions subscribers.

Although proponents for technologies such as mobile WiMAX point to lower costs for their technology, there doesn't seem to be any inherent cost advantage to these alternatives, even on an equal volume basis. And when factoring in the lower volumes, any cost advantage is debatable. Some have pointed to lower IPR costs with OFDM-based solutions, and perhaps IPR will be less centralized with OFDM than with CDMA. However, OFDM-related IPR issues are still very much in their early stages, and it could take years for these issues to be fully understood and resolved.

The advantages of high volume can be seen in projections for GSM handsets. At this year's 3GSM World Congress, GSM Association CEO Rob Conway⁶⁵ indicated that the

⁶⁴ Source: 3G Americas' member company. Comparison based on transmission of files of 2MBytes or less. For the RF portion only the power draw from the power amplifier is considered.

organization's "Emerging Market Handset" initiative would enable sub-\$15 devices by 2008. This follows the successful availability of sub-\$30 handsets.

As for UMTS/HSPA versus CDMA2000, five times higher deployment could translate to significant cost gains. For example, research and development amortization results in a four-to-one difference in base station costs.⁶⁶ Similarly, just as GSM handsets are much less expensive than 1xRTT handsets, UMTS wholesale terminal prices will soon be significantly lower than EV-DO terminal prices.

Competitive Summary

Based on the information presented in this paper, Table 10 summarizes the competitive position of the different technologies.

Table 10: Competitive Position of Major Wireless Technologies

Technology	EDGE/HSPA/LTE	CDMA2000	IEEE 802.16e WiMAX
Subscribers	Over 2 billion today; 3 billion expected by 2010	275 million ⁶⁷ today; slower growth expected than GSM/UMTS	Approximately 16 million expected by 2010
Maturity	Extremely mature	Extremely mature	Emerging/immature
Adoption	Cellular operators globally	Cellular operators globally	Extremely limited to date
Coverage	Global	Global with the general exception of Western Europe	None
Devices	Broad selection of GSM/EDGE/UMTS/HSDPA devices	Broad selection of 1xRTT/EV-DO devices	None yet; initial devices likely to emphasize data
Radio Technology	Highly optimized TDMA for EDGE, highly optimized CDMA for HSPA, highly optimized OFDMA for LTE	Highly optimized CDMA for Rev 0/A/B, highly optimized OFDMA for Rev C	Optimized OFDMA in Phase I, highly optimized OFDMA in Phase II
Spectral Efficiency	Very high with HSPA, matches OFDMA approaches in 5 MHz with HSPA+	Very high with EV-DO Rev A/B	Very high but as yet unproven

⁶⁵ Reported in the article "Mobile phones on the catwalk" by Paul Rasmussen. GSM Association, Wireless Business Review, Spring 2006.

⁶⁶ Source: 3G Americas member analysis.

⁶⁷ Source: CDG, August 2006.

Technology	EDGE/HSPA/LTE	CDMA2000	IEEE 802.16e WiMAX
Throughput Capabilities	Peak downlink user-achievable rates of 1 over Mbps today with higher rates in the future	Peak downlink user-achievable rates of over 1 Mbps	Peak downlink user-achievable rates will depend on network design
Latency	As low as 70 msec with HSDPA	Approximately 150 msec with EV-DO Rev 0	To be determined
Voice Capability	Extremely efficient circuit-voice available today; smoothest migration to VoIP of any technology	Extremely efficient circuit-voice available today Challenging transition to VoIP	Relatively inefficient VoIP initially; more efficient in later stages Voice coverage will be much more limited than cellular
Simultaneous Voice and Data	Available with UMTS today	Not available today	Potentially available, though initial services will emphasize data
Efficient Spectrum Usage	Entire UMTS radio channel available for any mix of voice and high-speed data	Radio channel today limited to either voice/medium speed data or high-speed data only	Efficient for data-centric networks only until later versions

Conclusion

The EDGE/HSPA/LTE family of technologies provides operators and subscribers many advantages. The continued use of GSM technology through ongoing enhancements, referred to as Enhanced GSM EDGE Radio Access Network, allows operators to leverage existing investments. With UMTS/HSPA, the technologies' advantages provide for broadband services that will deliver increased data revenue as well as a path to all-IP architectures. With LTE, the advantages offer a best-of-breed long-term solution that matches the performance of all competing approaches. In all cases, the different radio-access technologies can coexist using the same core architecture.

Today, HSDPA offers the highest peak data rates of any widely available, wide-area wireless technology with the lowest latency. With continued evolution, peak data rates keep increasing, spectral efficiency increases, and latency decreases. The result is support for more users at higher speeds with more applications enabled. Application scope will also increase with quality-of-service control and multimedia support. Greater efficiencies will translate to more competitive offers, greater network usage, and increased revenues.

The migration and benefits of the evolution from GPRS/EDGE to HSPA and then to LTE are both practical and inevitable. Combined with the ability to roam globally, huge economies of scale, widespread acceptance by operators, complementary services such as multimedia messaging, and a wide variety of competitive handsets and other devices, the result is a compelling technology family for both users and operators. Today, over 100 commercial UMTS networks are already in operation. Nearly all major regional standardization bodies support UMTS. It offers an excellent migration path for GSM operators as well as an effective technology solution for Greenfield operators.

EDGE has proven to be a remarkably effective and efficient technology for GSM networks. It achieves high spectral efficiency and data performance that today support a wide range of applications. Evolved EDGE, available in the 2007 time frame as part of Release 7, will greatly enhance EDGE capabilities—more than quadrupling throughputs.

Beyond EDGE, many operators have deployed UMTS Release 99 technology to provide peak user-achievable rates of 350 kbps with current devices and to support many new high-bandwidth applications. Whereas EDGE is extremely efficient for narrowband data services, the WCDMA radio link is efficient for wideband services. EDGE and WCDMA provide the capabilities to make entire cities and countries “broadband hotspots.” Unlike some competing technologies, UMTS today offers users simultaneous voice and data as well as allows operators to support voice and data across their entire available spectrum. Combined with a comprehensive QoS framework and multimedia support, a network employing both EDGE and UMTS provides an optimal solution for a broad range of usages.

HSDPA significantly enhances UMTS by providing a broadband data service with user-achievable rates often exceeding 1 Mbps in initial deployments. Today’s devices support peak network rates of 3.6 Mbps, and the technology itself has a theoretical maximum network rate of 14 Mbps. HSDPA achieves its high speeds through techniques similar to those that propel EDGE performance past GPRS as well as through the addition of powerful new techniques such as fast scheduling. Like EDGE, HSDPA can be deployed as a software-based upgrade and is currently being deployed around the world. More than 42 networks are now available.

HSDPA and its advanced evolution can compete against any other technology in the world, and it is widely expected that most all UMTS operators will eventually upgrade to this technology. While HSDPA improves throughput speeds and spectral efficiency for the downlink, HSUPA will improve these for the uplink. Other innovations, such as MIMO, will be deployed over the next several years. Evolved HSPA+ systems, with peak rates of 28 Mbps or higher, will match the throughput and capacity of OFDMA-based approaches. 3GPP adopted OFDMA with 3GPP Long Term Evolution, which will provide a growth platform for the next decade.

With the continued growth in mobile computing, powerful new handheld computing platforms, an increasing amount of mobile content, multimedia messaging, mobile commerce, and location services, wireless data has slowly but inexorably become a huge industry. EDGE/HSPA/LTE provides one of the most robust portfolios of mobile-broadband technologies and is an optimum framework for realizing the potential of this market.

This white paper was written for 3G Americas by Rysavy Research (<http://www.rysavy.com>) and utilized a composite of statistical information from multiple resources.

Additional Information

3G Americas maintains complete and current lists of market information, including EDGE, UMTS, and HSPDA deployments worldwide, available for free download on our website, www.3gamericas.org.

If there are any questions regarding the download of this information, please call +1 425 372 8922 or email Angela Dy, Public Relations Administrator, info@3gamericas.org.

References

3G Americas: "The Evolution of UMTS, 3GPP Release 5 and Beyond," June 2004

3G Americas: "The Global Evolution of UMTS/HSDPA - 3GPP Release 6 and Beyond," July 2005

3G Americas: "Mobile Broadband: The Global Evolution of UMTS/HSPA – 3GPP Release 7 and Beyond," July 2006

AT&T Wireless: research data, July 2002, November 2003, June 2004, submission to 3G Americas

CDMA Developer Group, <http://www.cdg.org>, July 29, 2006

Cingular Wireless: "Competitive Technology Outlook," June 2006, submission to 3G Americas

Cingular Wireless: "Spectrum Efficiency Comparison, GSM vs. UMTS vs. 1XRTT" - research material, March 14, 2002, submission to 3G Americas

Cingular Wireless: uplink throughput data, June 2006, submission to 3G Americas

Dow Jones NY: "3G Retains its Buzz but Potential Remains Unclear," January 27, 2006

C. Edwards, P. Clark, S. Ohr, "Power Problems Threaten Launch of 3G Handsets," EE Times, Feb. 14, 2000

Ericsson: "The 3G Long-Term Evolution – Radio Interface Concepts and Performance Evaluation," 2006

Ericsson: "3GPP Improved UE Receiver Requirements," June 2006, submission to 3G Americas

Ericsson: "Cellular Evolution," May 2006, submission to 3G Americas

Ericsson: "Delay Versus Capacity Trade Off," July 2005, submission to 3G Americas

Ericsson: "HSDPA Performance," July 2005, submission to 3G Americas

Ericsson: "Long Term Evolution of 3G," Ericsson Review No. 2, 2005

Ericsson: "Measurement TCP Throughput over HSDPA," July 2005, submission to 3G Americas

Ericsson: "Technology Comparison," July 2005, submission to 3G Americas

Ericsson: "Uplink Capacity Evaluations," July 2005, submission to 3G Americas

Ericsson: "WCDMA, EDGE and cdma2000 - Capacity for Packet Data Services," July 2002, submission to 3G Americas

Ericsson white papers: "Broadband Data Performance of Third-Generation Mobile Systems" and "GSM to WCDMA the Global Choice" by Johan Skold, Magnus Lundevall, Stefan Parkvall, and Magnus Sundelin. 2002

Ericsson: "Advanced Receivers for WCDMA Terminal Platforms and Base Stations," Ericsson Review No. 2, 2006

Ericsson: "GSM/EDGE Continued Evolution," Ericsson Review No. 1, 2006

Ericsson: "HSDPA performance - HSDPA and R99 on Same Carrier," June 2006, submission to 3G Americas

Ericsson: HSPA voice migration, June 2006, submission to 3G Americas

Ericsson: Marten Ericson, Stefan Wanstedt, Jonas Pettersson, "Effects of Simultaneous Circuit and Packet Switched Voice Traffic on Total Capacity"

Ericsson: "Providing Reliable and Efficient VoIP over WCDMA," Ericsson Review No. 2, 2005

Ericsson: "WCDMA vs. CDMA Business View," 2006, submission to 3G Americas

Ericsson white paper: "WCDMA Evolved, The first step – HSDPA," May 2004

Ericsson white paper: "WiMAX – Copper in the Air," April 2006

Ericsson, Nokia, Siemens: "Agreed Data Performance Characterization for EGPRS, WCDMA and CDMA2000 1XRTT," September 20, 2002, submission to 3G Americas

Senza Fili Consulting: Trendsmedia Telebriefing, June 21, 2006

Gartner Group: "Forecast: Mobile Terminals, Worldwide, 2000-2009 (4Q05 Update)," January 12, 2006

GSM Association: "Mobile phones on the catwalk" by Paul Rasmussen. Wireless Business Review, Spring 2006

Timo Halonen, Javier Romero and Juan Melero: "GSM, GPRS and EDGE Performance - GSM Evolution towards 3G/UMTS," May 13, 2002

Harri Holma and Antti Toskala: "WCDMA for UMTS," 3rd edition, John Wiley & Sons, July 2004

Informa Telecoms & Media: World Cellular Information Service "Global UMTS Network Status," July 26, 2005

Informa Telecoms & Media: World Cellular Information Service, August 2006

iSuppli Corp.: "Mobile-Phone Premium Content Market to Reach \$40 billion by 2010," www.cellular-news.com/story/16425.php, March 8, 2006

Lucent: "3GPP Rel'7 Enhancement Concepts," July 2005, submission to 3G Americas

Lucent: "Benefits of MIMO: BLAST vs. SDMA," July 2005, submission to 3G Americas

Lucent: "Comparative Spectral Efficiency," July 2005, submission to 3G Americas

Lucent: "HSDPA Test Results," July 2005, submission to 3G Americas

Lucent: "Link Capacity for Various Rate-Controlled Technologies," July 2005, submission to 3G Americas

Lucent: "Performance of VoIP on Dynamic Shared Channels," July 2005, submission to 3G Americas

Lucent: "UMTS Data Performance from Simulations and Field Data Measurements," submission to 3G Americas

Lucent: "Technical Comparison," August 2006, submission to 3G Americas

E. McCune, "System Implications of Heat in Wireless High-Speed Data Networks, " IEEE RAWCON 2000 Conference Proceedings, Denver, CO, September 2000

Motorola: "Performance of 3GPP High Speed Downlink Packet Access (HSDPA)," by Robert Love, Amitava Ghosh, Weimin Xiao, and Rapeepat Ratasuk, 2004

Nokia: "3GPP vs. 3GPP2 Cellular VoIP Driver Comparison," June 2006, submission to 3G Americas

Nokia: "A Comparison Between EDGE and Alternative Technologies," June 5, 2001, www.3gamericas.org

Nokia datasheet: "Nokia High Speed Packet Access Solution," 2004

Nokia: "HSDPA and the Shannon Limit," July 2005, submission to 3G Americas

Nokia: "HSDPA Performance Measurements with Commercial QPSK (CAT 12) and 16QAM (CAT 6)," June 2006, submission to 3G Americas

Nokia: performance data for HSDPA and E-DCH, July 2005, submission to 3G Americas

Nokia: performance analysis of WCDMA and HSDPA, July 2004, submission to 3G Americas

Nokia: "EGPRS Throughput versus Path Loss," October 5, 2002, submission to 3G Americas

Nokia: "Future Voice Traffic: Primary vs. Secondary?" June 2006, submission to 3G Americas

Nokia: "VoIP over HSPA with 3GPP Release 7," by Harry Holma, et. al., 2006

Nokia: "Overview on HSPA+," June 2006, submission to 3G Americas

Nokia: "Positioning of Future Access Network Alternatives," June 2006, submission to 3G Americas

Nokia: "HSUPA Simulation Results," May 2006, submission to 3G Americas

Nokia: "SAE Evolved Architecture," June 2006, submission to 3G Americas

Nokia: "WCDMA CS vs. HSPA VoIP Capacity Difference," June 2006, submission to 3G Americas

Nortel Networks: "A MIMO-OFDM Prototype for Next-Generation Wireless WANs," by Christian Dubuc, David Starks, Tim Creasy, and Yong Hou, December 2004, IEEE Communications

Nortel Networks: IEEE 802.16e-2005 and HSDPA performance analysis, July 2005, submission to 3G Americas

Nortel Networks: MIMO-OFDM performance analysis, July 2005, submission to 3G Americas

Nortel Networks: "Nortel's GSM/EDGE Radio Access Network (GERAN) Evolution," 2006

Nortel Networks: latency and spectral efficiency data, July 2006, submission to 3G Americas

Nortel Networks: "WiMAX: Untethering the Internet User," by Bill Gage, Charlie Martin, Ed Sich, and Wen Tong, Nortel Technical Journal, Issue 2

Nortel Networks: "What 3G Applications & Services to Launch?" June 2004, submission to 3G Americas

Research in Motion: "EDGE Evolution, GERAN Update," June 2006

Rysavy Research: "Hard Numbers and Experts' Insights on Migration to 4G Wireless Technology," published by Datacomm Research, February 2005

Andy Seybold: "Will Data-Only Networks Ever Make Money?" January 18, 2006, commentary, <http://www.outlook4mobility.com/commentary2006/jan1806.htm>

Chetan Sharma: U.S. Wireless Data Market - Mid Year Update 2006, <http://www.chetansharma.com/midyearupdate06.htm>

The Shosteck Group, July 2006

Tropian Inc.: "Solving the Heat Problem in Wireless Data Terminals", E. McCune

Yankee Group: "Global Wireless/Mobile Premium Forecast," November 2005, © Copyright 1997-2006. Yankee Group Research Inc. All rights reserved.

Rysavy Research provides this document and the information contained herein to you for informational purposes only. Rysavy Research provides this information solely on the basis that you will take responsibility for making your own assessments of the information.

Although Rysavy Research has exercised reasonable care in providing this information to you, Rysavy Research does not warrant that the information is error-free. Rysavy Research disclaims and in no event shall be liable for any losses or damages of any kind, whether direct, indirect, incidental, consequential, or punitive arising out of or in any way related to the use of the information.

Acronyms

The following are the acronyms used in this paper. Acronyms are defined the first time they are used.

1xEV-DO – Evolved, Data Voice
1xEV-DV – Evolved, Data Voice
1XRTT – One Carrier Radio Transmission Technology
2G – Second Generation
3G – Third Generation
3GPP – Third Generation Partnership Project
3GPP2 – Third Generation Partnership Project 2
4G – Fourth Generation
8-PSK – Octagonal Phase Shift Keying
AAS – Adaptive Antenna Systems
AMR – Adaptive Multi Rate
ANSI – American National Standards Institute
ARQ – Automatic Repeat Request
ARPU – Average Revenue Per User
AWGN – Additive White Gaussian Noise Channel
BCCH – Broadcast Control Channel
BRS – Broadband Radio Service
BSC – Base Station Controller
BTS – Base Transceiving Station
C/I – Carrier to Interference Ratio
CDF – Cumulative Distribution Function
CDMA – Code Division Multiple Access
dB – Decibel
DTM – Dual Transfer Mode
D-TxAA – Double Transmit Adaptive Array
DVB-H – Digital Video Broadcasting Handheld
E-DCH – Enhanced Dedicated Channel
EBCMCS – Enhanced Broadcast Multicast Services
EDGE – Enhanced Data Rates for GSM Evolution
EGPRS – Enhanced General Packet Radio Service
ETSI – European Telecommunications Institute
EV-DO – One Carrier Evolved Data Optimized
EV-DV – One Carrier Evolved Data Voice
FBAR – Film Bulk Acoustic Resonator
FDD – Frequency Division Duplex

Flash OFDM – Fast Low-Latency Access with Seamless Handoff OFDM

FLO – Forward Link Only

FTP – File Transfer Protocol

Gbps – Gigabits per second

GERAN – GSM EDGE Radio Access Network

GGSN – Gateway GPRS Support Node

GMSK – Gaussian Minimum Shift Keying

GPRS – General Packet Radio Service

GSM – Global System for Mobile communications

GSMA – GSM Association

HARQ – Hybrid Automatic Repeat Request

HLR – Home Location Register

HSDPA – High Speed Downlink Packet Access

HS-DSCH – High Speed-Downlink Shared Channels

HS-PDSCH - High Speed Physical Downlink Shared Channels

HSPA – High Speed Packet Access (HSDPA with HSUPA)

HSPA+ – HSPA Evolution

HSS – Home Subscriber Server

HSUPA – High Speed Uplink Packet Access

IETF – Internet Engineering Taskforce

IMS – IP Multimedia Subsystem

IP – Internet Protocol

ITU – International Telecommunications Union

JCP – Java Community Process

kbps – Kilobits Per Second

LAN – Local Area Network

LTE – Long Term Evolution

MBMS - Multimedia Broadcast/Multicast Service

Mbps – Megabits Per Second

Mcps – Megachips Per Second

MCS – Modulation and Coding Scheme

MIMO – Multiple Input Multiple Output

MMDS – Multichannel Multipoint Distribution Service

MME – Mobile Management Entity

MRxD – Mobile Receive Diversity

MMSE – Minimum Mean Square Error

MSC – Mobile Switching Center

msec – millisecond

OFDM – Orthogonal Frequency Division Multiplexing

OFDMA – Orthogonal Frequency Division Multiple Access

PAR – Peak to Average Ratio
PARC – Per-Antenna Rate Control
PBCH – Packet Broadcast Control Channel
PCRF – Policy Control and Charging Rules Function
PoC – Push-to-talk over Cellular
QAM – Quadrature Amplitude Modulation
QoS – Quality of Service
QPSK – Quadrature Phase Shift Keying
RAB – Radio Access Bearer
RLC – Radio Link Control (layer 2)
RNC – Radio Network Controller
RTP – Real Time Transport Protocol
RTSP – Real Time Streaming Protocol
SCFDMA – Single Carrier Frequency Division Multiple Access
SAE – System Architecture Evolution
SDMA – Space Division Multiple Access
SDP – Session Description Protocol
SGSN – Serving GPRS Support Node
SIP – Session Initiation Protocol
SMS – Short Message Service
SNR – Signal to Noise Ratio
TCH – Traffic Channel
TDD – Time Division Duplex
TDMA – Time Division Multiple Access
TD-SCDMA – Time Division Synchronous CDMA
TISPAN – Telecoms and Internet converged Services and Protocols for Advanced Networks
TTI – Transmission Time Interval
UMA – Unlicensed Mobile Access
UMTS – Universal Mobile Telecommunications System
UPE – User Plane Entity
UTRAN – UMTS Terrestrial Radio Access Network
VoIP – Voice over Internet Protocol
VPN – Virtual Private Network
WAN – Wide Area Network
WAP – Wireless Application Protocol
WCDMA – Wideband CDMA
Wi-Fi – Wireless Fidelity
WiMAX – Worldwide Interoperability for Microwave Access
WLAN – Wireless Local Area Network