

EDGE, HSPA and LTE BROADBAND INNOVATION

September 2008



RYSAVY
RESEARCH

TABLE OF CONTENTS

INTRODUCTION	3
BROADBAND DEVELOPMENTS	5
WIRELESS DATA MARKET	8
Trends	9
EDGE/HSPA/HSPA+ Deployment.....	13
Statistics	13
WIRELESS TECHNOLOGY EVOLUTION AND MIGRATION	15
Technical Approaches (TDMA, CDMA, OFDMA)	15
3GPP Evolutionary Approach	17
Spectrum	20
Core-Network Evolution.....	22
Service Evolution.....	23
Broadband-Wireless Deployment Considerations	24
Feature and Network Roadmap.....	25
COMPETING TECHNOLOGIES	29
CDMA2000	29
WiMAX	32
IEEE 802.20.....	35
Wi-Fi and Municipal Wi-Fi Systems	35
COMPARISON OF WIRELESS TECHNOLOGIES	36
Data Throughput	36
HSDPA Throughput in Representative Scenarios	40
Release 99 and HSUPA Uplink Performance	41
LTE Throughput.....	42
Latency.....	43
Spectral Efficiency	44
Cost, Volume and Market Comparison	52
Competitive Summary.....	54
CONCLUSION	56
APPENDIX: TECHNOLOGY DETAILS	58
EDGE	58
Evolved EDGE	62
UMTS/HSPA Technology	70
UMTS Release 99 Data Capabilities.....	72
HSDPA.....	73
HSUPA	76
Evolution of HSPA (HSPA+).....	78
HSPA Voice Support.....	84
3GPP LTE	86
4G, IMT-Advanced and LTE Advanced	89
UMTS TDD.....	90
TD-SCDMA	91
IMS	91
Broadcast/Multicast Services	93
EPC/SAE.....	94
ACRONYMS	96
ADDITIONAL INFORMATION	100
REFERENCES	100

Introduction

Through constant innovation, Universal Mobile Telecommunications System (UMTS) with High Speed Packet Access (HSPA) technology and its evolution to beyond third generation (3G) has established itself as *the* global, mobile-broadband solution. Building on the phenomenal success of Global System for Mobile Communications (GSM), the GSM/UMTS ecosystem is becoming the most successful communications technology family ever. Through a process of constant improvement, the GSM family of technologies has not only matched or exceeded the capabilities of all competing approaches, but has significantly extended the life of each of its member technologies.

UMTS/HSPA, in particular, has many key technical and business advantages over other mobile wireless technologies. Operators worldwide are now deploying both High Speed Downlink Packet Access (HSDPA) and High Speed Uplink Packet Access (HSUPA), the combination of the two technologies called simply HSPA. HSPA is one of the most powerful cellular-data technologies ever developed. HSPA, already widely available, follows the successful deployment of UMTS networks around the world and is now a standard feature. Any operator deploying UMTS today is doing so with HSPA. The UMTS-to-HSPA upgrade is similar to Enhanced Data Rates for GSM Evolution (EDGE), which has already proven to be a remarkably effective upgrade to GSM networks, and HSPA (or HSDPA for some networks) is now supported by an overwhelming number of operators and vendors worldwide.

HSPA is strongly positioned to be the dominant mobile-data technology for the rest of the decade. To leverage operator investments in HSPA, the 3GPP (Third Generation Partnership Project) standards body has developed a series of enhancements to create “HSPA Evolution,” also referred to as “HSPA+.” HSPA Evolution represents a logical development of the Wideband Code Division Multiple Access (WCDMA) approach, and it is the stepping stone to an entirely new Third Generation Partnership Project (3GPP) radio platform called 3GPP Long Term Evolution (LTE). LTE, which uses Orthogonal Frequency Division Multiple Access (OFDMA), should be ready for deployment in the 2010 timeframe. Simultaneously, 3GPP — recognizing the significant worldwide investments in GSM networks—has defined enhancements that will significantly increase EDGE data capabilities through an effort called Evolved EDGE.

Combined with these improvements in radio-access technology, 3GPP has also spearheaded the development of major core-network architecture enhancements such as the IP Multimedia Subsystem (IMS) and the Evolved Packet Core (or EPC, previously called System Architecture Evolution or SAE), as well as developments in Fixed Mobile Convergence (FMC). These developments will facilitate new types of services, the integration of legacy and new networks, the convergence between fixed and wireless systems, and the transition from circuit-switched approaches for voice traffic to a fully packet-switched model.

The result is a balanced portfolio of complementary technologies that covers both radio-access and core networks, provides operators maximum flexibility in how they enhance their networks over time, and supports both voice and data services.

This paper discusses the evolution of EDGE, HSPA enhancements, 3GPP LTE, the capabilities of these technologies, and their position relative to other primary competing technologies. The following are some of the important observations and conclusions of this paper:

- Persistent innovation created EDGE, which was a significant advance over GPRS; HSPA and HSPA+, which are bringing UMTS to its full potential; and is now delivering LTE, the most powerful, wide-area wireless technology ever developed.

- ❑ GSM/UMTS has an overwhelming global position in terms of subscribers, deployment, and services. Its success will marginalize other wide-area wireless technologies.
- ❑ In current deployments, HSPA users regularly experience throughput rates well in excess of 1 megabit per second (Mbps), under favorable conditions, on both downlinks and uplinks. Planned enhancements will increase these peak user-achievable throughput rates, with 4 Mbps on commercial networks being commonly measured.
- ❑ HSPA Evolution provides a strategic performance roadmap advantage for incumbent GSM/UMTS operators. HSPA+ with 2x2 MIMO, successive interference cancellation, and 64 Quadrature Amplitude Modulation (QAM) is more spectrally efficient than competing technologies including Worldwide Interoperability for Microwave Access (WiMAX) Wave 2 with 2x2 MIMO and Evolved Data Optimized (EV-DO) Revision B.
- ❑ The LTE Radio Access Network technical specification was approved in January 2008 and is being incorporated into 3GPP Release 8, which is close to completion. Initial deployments are likely to occur around 2010. The 3GPP OFDMA approach used in LTE matches or exceeds the capabilities of any other OFDMA system. Peak theoretical rates are 326 Mbps in a 20 MHz channel bandwidth. LTE assumes a full Internet Protocol (IP) network architecture, and it is designed to support voice in the packet domain.
- ❑ LTE has become the technology platform of choice as GSM/UMTS and CDMA/EV-DO operators are making strategic long-term decisions on their next-generation platforms. In June of 2008, after extensive evaluation, LTE was the first and only technology recognized by the Next Generation Mobile Network alliance to meet its broad requirements.
- ❑ GSM/HSPA will comprise the overwhelming majority of subscribers over the next five to ten years, even as new wireless technologies are adopted. The deployment of LTE and its coexistence with UMTS/HSPA will be analogous to the deployment of UMTS/HSPA and its coexistence with GSM.
- ❑ 3GPP is now studying how to enhance LTE to meet the requirements of IMT-Advanced in a project called LTE Advanced.
- ❑ UMTS/HSPA/LTE have significant economic advantages over other wireless technologies.
- ❑ WiMAX has developed an ecosystem supported by many companies, but it will still only represent a very small percentage of wireless subscribers over the next five to ten years.
- ❑ EDGE technology has proven extremely successful and is widely deployed on GSM networks globally. Advanced capabilities with Evolved EDGE can double and eventually quadruple current EDGE throughput rates.
- ❑ With a UMTS multiradio network, a common core network can efficiently support GSM, WCDMA, and HSPA access networks and offer high efficiency for both high and low data rates, as well as for both high- and low-traffic density configurations. In the future, EPC/SAE will provide a new core network that supports both LTE and interoperability with legacy GSM/UMTS radio-access networks.
- ❑ Innovations such as EPC/SAE and UMTS one-tunnel architecture will “flatten” the network, simplifying deployment and reducing latency.

- ❑ Circuit-switched, voice over HSPA, then moving to Voice over Internet Protocol (VoIP) over HSPA will add to voice capacity and reduce infrastructure costs. In the meantime, UMTS/HSPA enjoys high circuit-switched voice spectral efficiency, and it can combine voice and data on the same radio channel.

This paper begins with an overview of the market, looking at trends, EDGE and UMTS/HSPA deployments, and market statistics. It then examines the evolution of wireless technology, particularly 3GPP technologies, including spectrum considerations, core-network evolution, broadband-wireless deployment considerations, and a feature and network roadmap. Next, the paper discusses other wireless technologies, including Code Division Multiple Access 2000 (CDMA2000), Ultra Mobile Broadband (UMB), and WiMAX. Finally, it compares the different wireless technologies technically, based on features such as performance and spectral efficiency.

The appendix explains in detail the capabilities and workings of the different technologies including EDGE, Evolved EDGE, WCDMA¹, HSPA, HSPA Evolution (HSPA+), LTE, IMS, and SAE.

Broadband Developments

As wireless technology represents an increasing portion of the global communications infrastructure, it is important to understand overall broadband trends and the role between wireless and wireline technologies. Sometimes wireless and wireline technologies compete with each other, but in most instances they are complementary. For the most part, backhaul transport and core infrastructure for wireless networks are based on wireline approaches, whether optical or copper. This applies as readily to Wi-Fi networks as it does to cellular networks.

Given that the inherent capacity of one fiber optical link exceeds the entire available radio frequency (RF) spectrum, data flow over wireless links will never represent more than a small percentage of the total global communications traffic. Nevertheless, wireless technology is playing a profound role in networking and communications, because it provides two fundamental capabilities: mobility and access. Mobility refers to untethered communication whether stationary or in motion. Access refers to communication services, whether telephony or Internet, easily provided across geographic areas and often more easily accomplished than with wireline approaches, especially in greenfield situations where there is little existing communications infrastructure. Thus, given these characteristics, mobile communications volume may be less than wireline, but its overall contribution to communications in the world and its social, political and economic impact, is just as significant.

The overwhelming global success of mobile telephony, and now the growing adoption of mobile data, conclusively demonstrate the desire for mobile-oriented communications. The question of using wireless technology, however, for access is more complex. One must consider the performance and capacity of wireless technologies relative to wireline approaches, what wireline infrastructure may already be available, and ongoing developments with wireline technology. In particular, wireline networks have always had greater capacity, and historically have delivered faster throughput rates. Figure 1 shows advances in typical user throughput rates, and a consistent 10x advantage of wireline technologies over wireless technologies.

¹ Although many use the terms "UMTS" and "WCDMA" interchangeably, in this paper we use "WCDMA" when referring to the radio interface technology used within UMTS and "UMTS" to refer to the complete system. HSPA is an enhancement to WCDMA.

Figure 1: Wireline and Wireless Advances

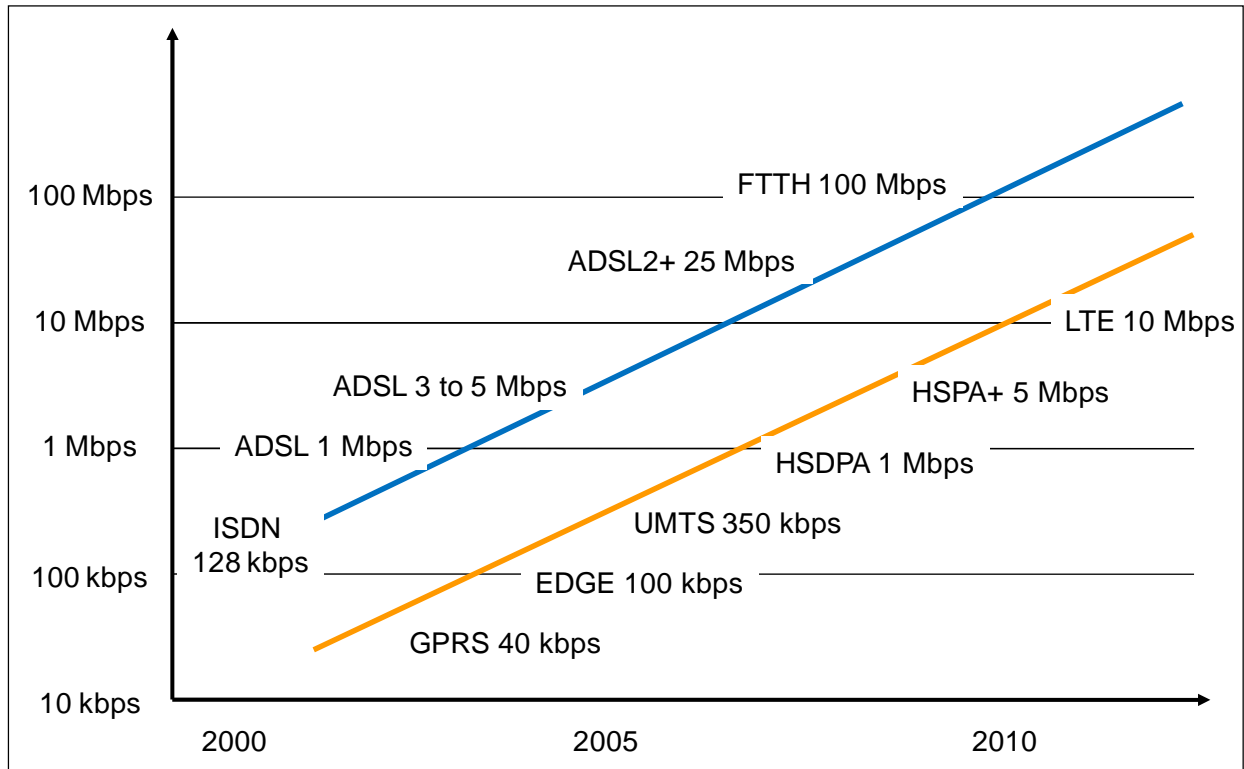

Mobile broadband combines compelling high-speed data services with mobility. Thus, the opportunities are limitless when considering the many diverse markets mobile broadband can successfully address. In developing countries, there is no doubt that 3G technology will cater to both enterprises and their high-end mobile workers and consumers, for whom 3G can be a cost-effective option, competing with digital subscriber line (DSL), for home use.

In the developed world, users' desire to be connected anytime, anywhere will be a primary source of demand. While consumer demand for social and search services, such as Facebook, MySpace, YouTube, Yahoo, and Google, increases the demand for mobile-broadband capabilities, the majority of early adopters of mobile broadband have been enterprises. Better connectivity means a business is more efficient. As a result, enterprise broadband-connectivity adoption is taking on the same "look and feel" as early mobile-phone service adoption. In the early 1990s, doctors, lawyers, salespeople, and executives already had home phones, office desk phones, and even receptionists. It was the productivity increases associated with being connected to a cellular network, however, that accelerated mobile-broadband growth throughout the world. Portio Research predicted in June 2008 that worldwide mobile data revenue would increase at an annual rate of 16 percent to reach \$252 billion the end of 2012.²

Overall, whether in business or in our personal lives, the world of voice and data is quickly becoming one that must be *untethered, but always connected*.

Although it is true that most 3G systems are now offering throughputs of about 1 Mbps—which is comparable to what many users experience with a basic DSL or cable-modem service—the overall capacity of wireless systems is generally lower than it is with wireline systems. This is especially true when wireless is compared to optical fiber, which some

² "Mobile Data Services Markets 2008", Portio Research, June 11, 2008

operators are now deploying to people’s homes. With wireline operators looking to provide 20 to 100 Mbps to either people’s homes or businesses via next-generation cable-modem services, very high-speed DSL (VDSL), or fiber—especially for services such as high-definition IP Television (IPTV)—the question becomes, is it possible to match these rates using wireless approaches? The answer is “yes” from a purely technical perspective, but it is “no” from a practical point of view. It is only possible to achieve these rates by using large amounts of spectrum, generally more than is available for current 3G systems, and by using relatively small cell sizes. Otherwise, it simply will not be possible to deliver the hundreds of gigabytes per month that users will soon be consuming over their broadband connections with wide-area wireless networks. Consider today’s high definition (HD) television content that demands 6 to 9 Mbps of continuous connectivity, where one subscriber could essentially consume the entire capacity of a WiMAX or HSPA cell sector. The only possible wireless approach to address such high-data consumption is with FMC approaches, such as femto cells (or dual mode Wi-Fi/3G devices, as shown in Figure 2. This presupposes, however, an existing wireline Internet connection (e.g., DSL).

Figure 2: FMC Used to Expand Capacity

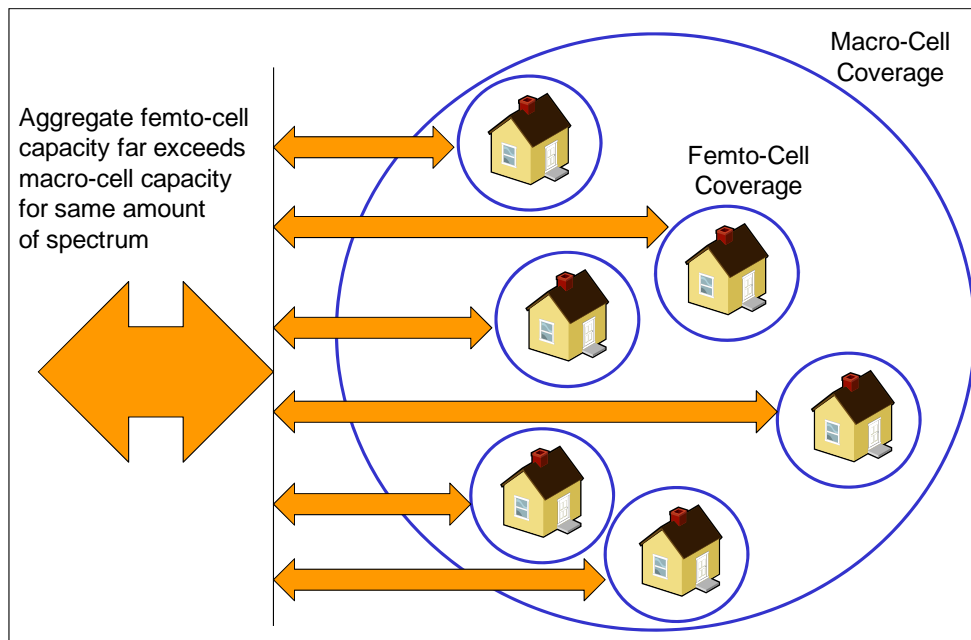

What makes much more sense today is using wireless technology for access only when there are no good wireline alternatives. Hence, the interest developing countries have in broadband-wireless technologies. What changes the dynamics of the business model in these areas is that operators can cost-effectively deploy voice (which is inherently low bandwidth) and lower-speed data services, mostly because of the lack of wireline offerings. Deploying at lower capacity—as measured by lower bits per second (bps) per square kilometer—means larger cell sizes, and thus fewer cell sites and much lower deployment costs.

Table 1 summarizes the strengths and weaknesses of wireless versus wireline broadband approaches.

Table 1: Strengths and Weakness of Broadband Approaches

	Strength	Weakness
Mobile broadband (EDGE, HSPA, LTE)	Constant connectivity Broadband capability across extremely wide areas Good access solution for areas lacking wireline infrastructure Capacity enhancement options via FMC Excellent voice communications	Lower capacity than wireline approaches Inability to serve high-bandwidth applications such as IP TV
Wireline broadband (e.g., DSL, DOCSIS, FTTH)	High capacity broadband at very high data rates Evolution to extremely high throughput rates	Expensive to deploy new networks, especially in developing economies lacking infrastructure

This is not a static situation, however. In the longer term, a number of developments could make high-capacity broadband-wireless systems more competitive with wireline approaches. Among these developments are mesh capabilities to reduce deployment costs, higher spectral efficiency, low-cost commoditized base stations, and future spectrum allocations for mobile-broadband systems. However, any such future success is somewhat speculative and dependent on many developments including technology and broadband application evolution.

3GPP technologies clearly address proven market needs; hence, their overwhelming success. The 3GPP roadmap, which anticipates continual performance and capacity improvements, provides the technical means to deliver on proven business models. As the applications for mobile broadband continue to expand, HSPA, HSPA+, LTE and LTE Advanced will continue to provide a competitive platform for tomorrow's new business opportunities.

Wireless Data Market

By August 2008, over 3.2 billion subscribers were using GSM/UMTS³—approaching an astonishing 50 percent of the world's total 6.7 billion population.⁴ Informa's World Cellular Information Service projects over 4 billion GSM/UMTS customers by 2010, with 742 million of these subscribers using UMTS services.⁵ 3G Americas President Chris Pearson states, "This level of wireless technology growth exceeds that of almost all other lifestyle-changing

³ Informa Telecoms & Media, August 2008.

⁴ http://en.wikipedia.org/wiki/World_population, July 2008

⁵ Informa Telecoms & Media, World Cellular Information Service, July 2008.

innovations.”⁶ Clearly, GSM/UMTS has established global dominance. Although voice still constitutes most cellular traffic, wireless data worldwide now comprises 17 percent of average revenue per user (ARPU). In the United States, wireless data is more than 20 percent of ARPU for the three largest operators.⁷ This number could easily double within three years, and operators across North and South America are confirming this growth with their reports of rising data ARPU.

This section examines trends and deployment, and then provides market data that demonstrates the rapid growth of wireless data.

Trends

Users are adopting wireless data across a wide range of applications, including e-mail, social networking, game downloads, instant messaging (IM), ringtones, and video. Wireless data in enterprise applications like group collaboration, enterprise resource planning (ERP), customer relationship management (CRM), and database access is also gaining acceptance. The simultaneous adoption by both consumers, for entertainment-related services, and businesses, to enhance productivity, increases the return-on-investment potential for wireless operators.

A number of important factors are accelerating the adoption of wireless data. These include increased user awareness, innovative “feature phones”, powerful smartphones, and global coverage. But two factors stand out: network capability and applications. Technologies such as GSM, UMTS, and HSPA support a wide range of applications, including standard networking applications and those designed for wireless. Meanwhile, application and content suppliers are optimizing their offerings or, in many cases, developing entirely new applications and content to target the needs and desires of mobile users.

Computing itself is becoming more mobile, and notebook computers and smartphones are now prevalent. In fact, all mobile phones are becoming “smart,” with some form of data capability, and leading notebook vendors are now offering computers with integrated 3G (e.g., HSPA) capabilities. Modems are available in multiple formats including USB devices, PC Cards and Express cards.

Computer manufacturers are also experimenting with new form factors, such as ultra-mobile PCs, “netbook” computers and mobile Internet devices (MIDs). Lifestyles at home and at work are increasingly mobile with more people traveling more often for business, for pleasure or in retirement. Meanwhile, the Internet is becoming progressively more intertwined with people’s lives providing communications, social networking, information, enhancements to memberships and subscriptions, community involvement, and commerce. Wireless access to the Internet in this environment is a powerful catalyst for the creation of new services. It also provides operators and other third-party providers with many new business opportunities.

As data constitutes a rising percentage of total cellular traffic, it is essential that operators deploy spectrally efficient data technologies that meet customer requirements for performance—especially because data applications can demand significantly more network resources than traditional voice services. Operators have a huge investment in spectrum and in their networks; data services must leverage these investments. It is only a matter of time before today’s more than 3 billion cellular customers start taking

⁶ 3G Americas press release of June 5, 2007.

⁷ <http://www.chetansharma.com/usmarketupdateq108.htm>

full advantage of data capabilities. This adoption will offer tremendous opportunities and the associated risks to operators as they choose the most commercially viable evolutionary path for migrating their customers. The EDGE/HSPA/LTE evolutionary paths provide data capabilities that address market needs and deliver ever-higher data throughputs, lower latency, and increased spectral efficiency.

Although wireless data has always offered a tantalizing vision of always-connected mobile computing, adoption has been slower than that for voice services. In the past several years, however, adoption has accelerated thanks to a number of key developments. Networks are much more capable, delivering higher throughputs at lower cost. Awareness of data capabilities has increased, especially through the pervasive success of Short Message Service (SMS), wireless e-mail, downloadable ringtones, and downloadable games. Widespread availability of services has also been important. The features found in cellular telephones are expanding at a rapid rate and today include large color displays, graphics viewers, still cameras, movie cameras, MP3 players, IM clients, e-mail clients, Push-to-Talk over Cellular (PoC), downloadable executable content capabilities, and ever more powerful browsers. All these capabilities consume data.

Meanwhile, smartphones, which emphasize a rich computing environment on a phone, represent the convergence of the personal digital assistant, a fully capable mobile computer, and a phone, all in a device that is only slightly larger than the average cellular telephone. Many users would prefer to carry one device that “does it all.” Smartphones, originally targeted for the high end of the market, are now available at much lower price points and thus affordable to a much larger market segment. ABI Research predicts that the smartphone market, which was 10% of the total market in 2007, will become 31% of the market in 2013.⁸ This number may be conservative as the iPhone demonstrates the latent market demand for devices that enable rich multimedia and communications capabilities.

As a consequence, this rich network and device environment is spawning the availability of a wide range of wireless applications and content. Because of its growing size—and its unassailable potential—application and content developers simply cannot afford to ignore this market. And they aren't. Consumer content developers are already successfully providing downloadable ringtones and games. Enabled by 3G network capabilities, downloadable and streaming music and video are not far behind. In the enterprise space, all the major developers now offer mobilized “wireless-friendly” components for their applications. A recent article in Network Computing surveyed major enterprise application vendors, including IBM, Oracle, Salesforce.com, SAP, and Sybase and found comprehensive support for mobile platforms from each of these vendors.⁹

Acting as catalysts, a wide array of middleware providers are addressing issues such as increased security (for example, Virtual Private Networks [VPNs]), switching between different networks (for example, WLANs to 3G), session maintenance under adverse radio conditions, and policy mechanisms that control application access to networks.

A number of other powerful catalysts are spurring wireless-data innovation. Pricing for unlimited¹⁰ usage has declined substantially for both laptop and handset plans, thus encouraging greater numbers of users to adopt data services. Operators are seeing

⁸ “One in Three Handsets Will Be a Smartphone by 2013”, March 2008, <http://www.wirelessweek.com/article.aspx?id=158452>

⁹ “Reach Me if You Can,” May 2007, Peter Rysavy, <http://www.rysavys.com/papers.html>

¹⁰ Typically, some restrictions apply.

considerable success with music sales. New services such as video sharing are being enabled by IMS, which will also facilitate FMC and seamless communications experiences that span cellular and Wi-Fi networks. Meanwhile, users are responding enthusiastically to location-based services, banks are letting their account holders manipulate their accounts using handheld devices, and users have an increasing number of mobile options for real-time travel information and manipulation of that information.

In the enterprise space, the first stage of wireless technology adoption was essentially to replace modem connectivity. The next was to offer existing applications on new platforms like smartphones. But the final, and much more important, stage is where jobs are reengineered to take full advantage of continuous connectivity. Selective tactical adoption of mobile applications such as wireless e-mail is a good starting point for many organizations. However, companies that carefully adopt mobile applications in a more strategic fashion across multiple business units are finding they can significantly increase their competitiveness.

Based on one leading UMTS/HSPA infrastructure vendor's statistics, Figure 3 compares the rapid growth in wireless data traffic compared to voice traffic. By the end of 2007, in HSPA coverage areas on a global basis, the volume of data traffic (indicated in gigabit per radio network controller [RNC] per hour) exceeded voice traffic.

Figure 3: UMTS/HSPA Voice and Data Traffic¹¹

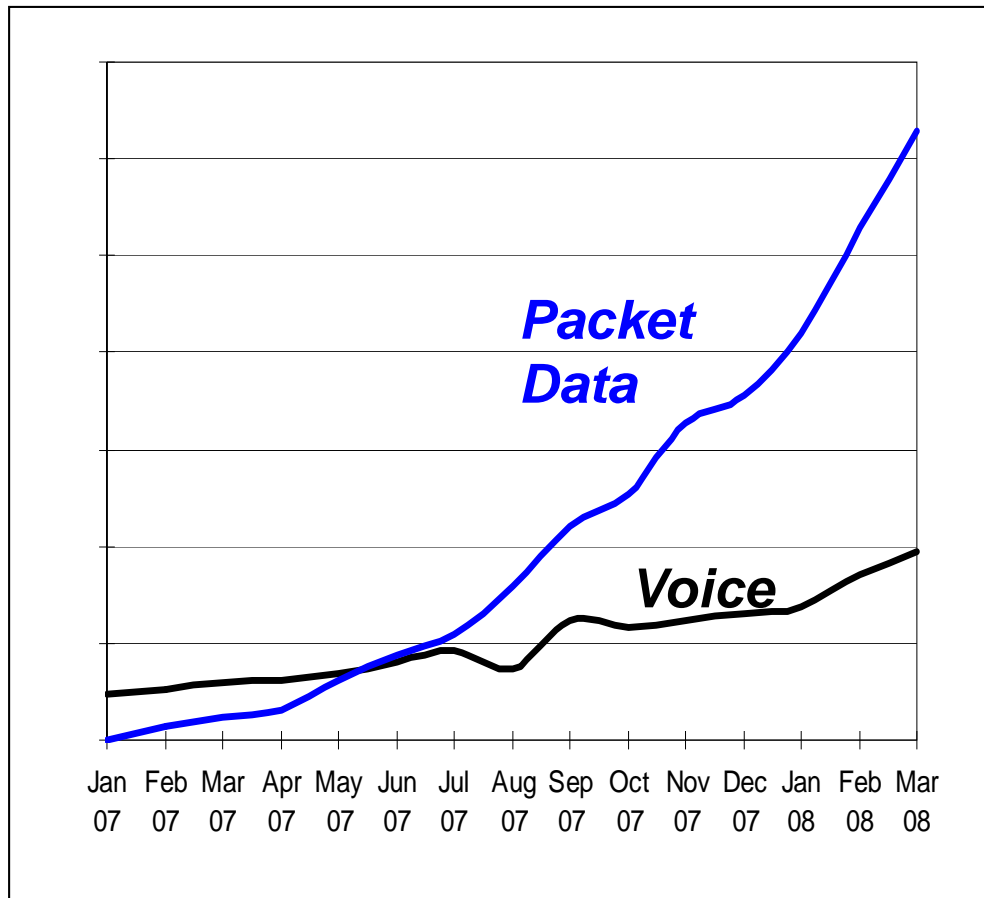

¹¹ Based on leading UMTS/HSPA infrastructure vendor statistics.

Over time, data demands are expected to grow significantly. Figure 4 shows a leading operator's assessment of data demands on its network.

Figure 4: Operator Assessment of Growth in Data Demand on Relative Basis¹²

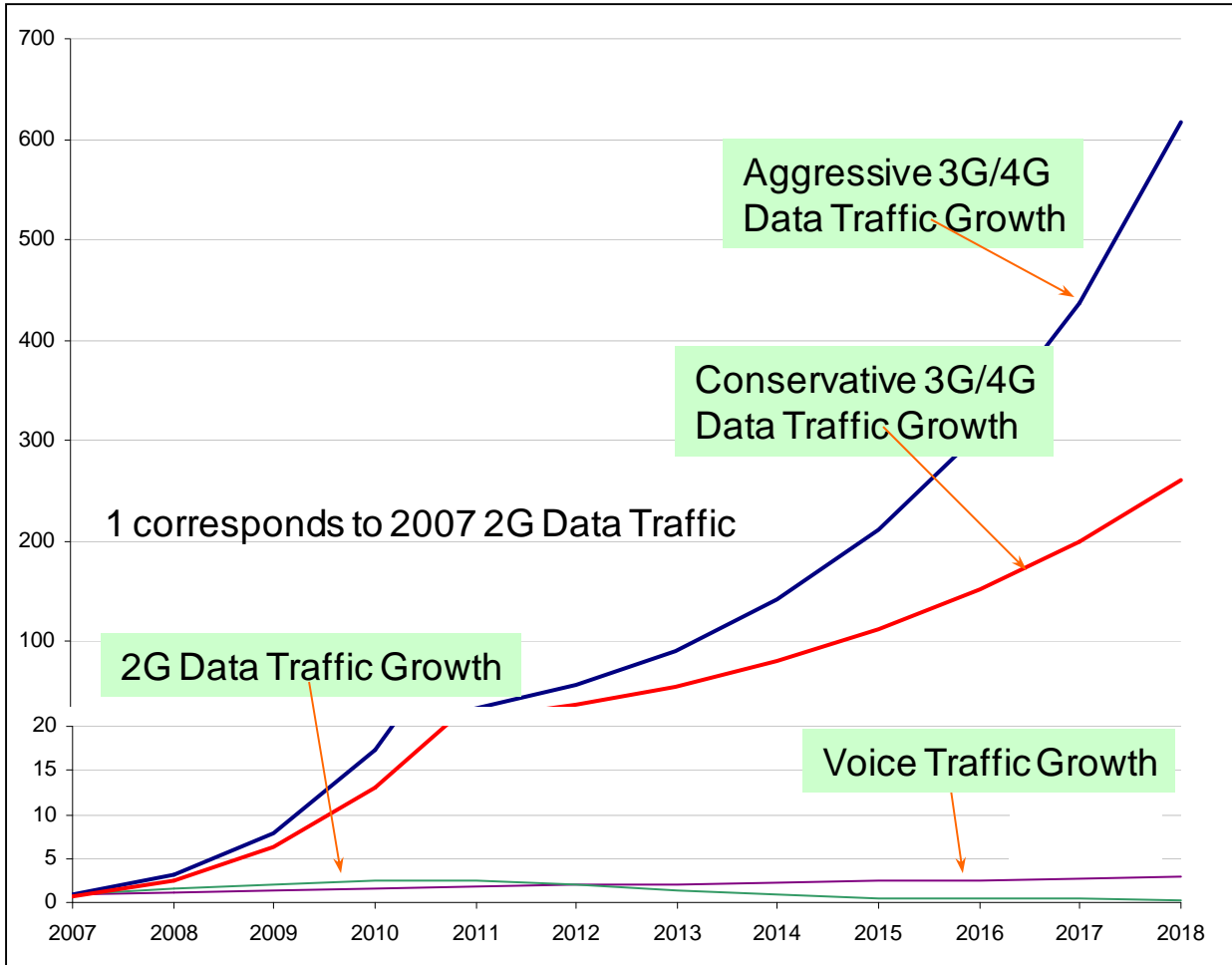

This figure is consistent with growth in mobile-broadband data consumption presented in a report from Value Partners¹³. The report projects for European countries 1 GByte/user/month using conservative assumptions, 8 GBytes/user/month with medium assumptions, and 30 Gbytes/user/month with aggressive assumptions.

Another driver for broadband data growth beyond mobile applications is the use of HSPA/LTE networks as alternatives to wireline networks where running wire or fiber is

¹² Source: 3G Americas member company contribution.

¹³ Value Partners, "Getting the Most Out of the Digital Divide – Allocating UHF Spectrum to Maximise the Benefits for European Society", March 2008, <http://www.spectrumstrategy.com/Pages/GB/perspectives/Spectrum-Getting-the-most-out-of-the-digita-dividend-2008.pdf>.

problematic. This includes developing economies, as well as remote areas. For example, Telstra is extending its HSPA network to remote mining locations and oil production platforms.¹⁴

A final factor accelerating adoption of mobile/wireless technologies is environmental considerations, where enhanced communications technologies facilitate business interaction with fewer face-to-face meetings, and make it easier for workers to either telecommute or stay involved with work projects as they conduct their personal affairs. With huge energy costs and pollution from fossil fuels, mobile broadband may increasingly be viewed as a “green” technology, and there is even a Web site (<http://www.green4g.com>) that promotes this cause.

The key for operators is enhancing their networks to support the demands of consumer and business applications as they grow, along with offering complementary capabilities such as IP-based multimedia. This is where the GSM family of wireless-data technologies is the undisputed leader. Not only does it provide a platform for continual improvements in capabilities, but it does so over huge coverage areas and on a global basis.

EDGE/HSPA/HSPA+ Deployment

Three quarters of GSM networks today support EDGE, representing more than 350 networks in approximately 150 countries.¹⁵

Because of the very low incremental cost of including EDGE capability in GSM network deployments, virtually all new GSM infrastructure deployments are also EDGE-capable and nearly all new mid- to high-level GSM devices include EDGE radio technology.

Meanwhile, UMTS has established itself globally. Nearly all WCDMA handsets are also GSM handsets, so WCDMA users can access the wide base of GSM networks and services. There are more than 251 million UMTS customers globally spanning 236 commercial networks. 211 operators in 90 countries offer HSDPA and 46 of these have HSUPA deployed.¹⁶ All UMTS operators are deploying HSPA for two reasons: first, the incremental cost of HSPA is relatively low and second, HSPA makes such efficient use of spectrum for data that it results in a much lower overall cost per megabyte of data delivered. Already, there are more than 724 commercial HSPA devices available worldwide.¹⁷ Devices include handsets, data cards, modems, routers, laptops, media players and cameras.

As for HSPA+, a number of operators have committed to the technology including AT&T and Telstra. As the technology matures, upgrading to HSPA+ will likely represent a minimal investment for operators in order to significantly boost network performance.

Statistics

A variety of statistics show the growth in wireless data. For instance, SNL Kagan states in a recent press release that Apple's iPhone 3G combined with other smartphone offerings will result in mobile data dominating the wireless industry. The report projects

¹⁴ Telstra presentation “HSPA as an Open Eco-System Today – Telstra Next G Network”, 2008.

¹⁵ “World Cellular Information Service,” Informa Telecoms & Media, June 2008.

¹⁶ Ibid.

¹⁷ GSA HSPA Devices Survey, July 21, 2008

mobile data revenues in the US to increase at a compound annual growth rate of 16% (from \$24 billion in 2007 to over \$100 billion in 2017.¹⁸)

Similarly, Chetan Sharma Consulting reports that US wireless data grew 8.6% in the second quarter of 2008 compared to the previous quarter and 40% compared to Q1 of 2007, reaching \$8.2 billion in revenue.¹⁹ On a global basis, Informa Telecoms and Media reported first quarter revenue of \$49 billion, a 42.7% year-to-year increase, resulting in more than \$200 billion of revenue for the year²⁰. Meanwhile, ABI Research found that cellular modem sales including PC Cards, Express Cards, USB modems, embedded modems and 3G/Wi-Fi routers together increased 300% in 2007 compared to the previous year.²¹

In research conducted by Wireless Intelligence and AT Kearney for the GSM Association, findings included 40% growth of the European Union's mobile data market in 2007 to 7 billion Euros, excluding SMS.²² The number of devices that support wireless data has partly fueled that data use. According to a study by the Online Publishers Association, 76 percent of all mobile phones are Web-enabled.²³ 3G is also fueling data adoption. According to Lehman Global Equity Research, 3G subscribers that use mobile data applications spend twice as much on data each month as 2G subscribers.²⁴

From a device perspective, Informa WCIS projected in July 2008 the following sales growth rate for WCDMA handsets: ²⁵

2008: 283 million
2009: 422 million
2010: 558 million
2011: 701 million
2012: 861 million
2013: 1.01 billion

It is clear that both EDGE and UMTS/HSDPA are dominant wireless technologies. And powerful data capabilities and global presence mean these technologies will likely continue to capture most of the available wireless-data market.

¹⁸ <http://www1.snl.com/press/20080731.asp>

¹⁹ Chetan Sharma: "US Wireless Data Market Update – Q2 2008", <http://www.chetansharma.com/usmarketupdateq108.htm>.

²⁰ Source: Informa Telecoms and Media, press release, July 23, 2008

²¹ <http://www.fiercewireless.com/press-releases/led-asia-pacific-suppliers-cellular-modem-industry-will-exceed-200-million-units-2013>

²² <http://www.cellular-news.com/story/31730.php?source=newsletter>

²³ Online Publishers Association study, March 8, 2007

²⁴ Lehman Global Equity Research, Paul Wuh, "Global 3G Developments: 3G subs accelerate; more data revenue in '09." May 23, 2008.

²⁵ "World Cellular Information Service," Informa Telecoms & Media, July 2008.

Wireless Technology Evolution and Migration

This section discusses the evolution and migration of wireless-data technologies from EDGE to LTE, as well as the evolution of underlying wireless approaches. Progress has occurred in multiple phases, first with EDGE, and then UMTS, followed by today's enhanced 3G capabilities such as HSPA, HSPA+ and, before long, LTE. Meanwhile, underlying approaches have evolved from Time Division Multiple Access (TDMA) to CDMA, and now from CDMA to OFDMA, which is the basis of LTE.

Technical Approaches (TDMA, CDMA, OFDMA)

Considerable discussion in the wireless industry has focused on the relative benefits of TDMA, CDMA, and, more recently, OFDMA. Many times, one technology or the other is positioned as having fundamental advantages over another. However, any of these three approaches, when fully optimized, can effectively match the capabilities of any other. GSM, which is based on TDMA, is a case in point. Through innovations like frequency hopping, the Adaptive Multi Rate (AMR) vocoder for voice, and EDGE for data performance optimization, GSM is able to effectively compete with the capacity and data throughput of CDMA2000 One Carrier Radio Transmission Technology (1xRTT).

Despite the evolution of TDMA capabilities, the cellular industry has generally adopted CDMA for 3G networking technology. Although there are some significant differences between CDMA2000 and WCDMA/HSPA, such as channel bandwidths and chip rates, both technologies use many of the same techniques to achieve roughly the same degree of spectral efficiency and typical performance. These techniques include efficient schedulers, higher order modulation, Turbo codes, and adaptive modulation and coding.

Today, people are asking whether Orthogonal Frequency Division Multiplexing (OFDM) and OFDMA²⁶ provide any inherent advantage over TDMA or CDMA. For systems employing 10 MHz or less of bandwidth, the answer is largely "no." Because it transmits mutually orthogonal subchannels at a lower symbol rate, the fundamental advantage of OFDM is that it elegantly addresses the problem of intersymbol interference induced by multipath and greatly simplifies channel equalization. As such, OFDM systems, assuming they employ all the other standard techniques for maximizing spectral efficiency, may achieve slightly higher spectral efficiency than CDMA systems. However, advanced receiver architectures—including options such as practical equalization approaches and interference cancellation techniques—are already commercially available in UMTS and CDMA chipsets and can nearly match this performance advantage.

It is with larger bandwidths of greater than 10 MHz and in combination with advanced antenna approaches such as MIMO or Adaptive Antenna Systems (AAS), that OFDM enables less computationally complex implementations than those based on CDMA. Hence, OFDM is more readily realizable in mobile devices. However, studies have shown that the complexity advantage of OFDM may be quite small (that is, less than a factor of two) if frequency domain equalizers are used for CDMA-based technologies. Still, the advantage of reducing complexity is one reason 3GPP chose OFDM for its LTE project. It is also one reason newer WLAN standards, which employ 20 MHz radio channels, are based on OFDM. In other words, OFDM is currently a favored approach under consideration for radio systems that have extremely high peak rates. OFDM also has an advantage in that it can scale easily for different amounts of available bandwidth. This in

²⁶ OFDMA is simply OFDM in which the system assigns different subcarriers to different users.

turn allows OFDM to be progressively deployed in available spectrum by using different numbers of subcarriers.

An OFDMA technology like LTE can also take better advantage of wider radio channels (for example, 10 MHz) by not requiring guard bands between radio carriers (for example, HSPA carriers). In recent years, the ability of OFDM to cope with multipath has also made it the technology of choice for the design of Digital Broadcast Systems.

In 5 MHz of spectrum, as used by UMTS/HSPA, continual advances with CDMA technology—realized in HSPA+ through approaches such as equalization, MIMO, interference cancellation, and higher-order modulation—will allow CDMA-based systems to largely match OFDMA-based systems.

Table 2 summarizes the attributes of the different wireless approaches.

Table 2: Summary of Different Wireless Approaches

Approach	Technologies Employing Approach	Comments
TDMA	GSM, GPRS, EDGE, Telecommunications Industry Association/Electronics Industry Association (TIA/EIA)-136 TDMA	First digital cellular approach. Hugely successful with GSM. New enhancements being designed for GSM/EDGE.
CDMA	CDMA2000 1xRTT, CDMA2000 EV-DO, WCDMA, HSPA, HSPA+ Institute of Electrical and Electronic Engineers (IEEE) 802.11b	Basis for nearly all new 3G networks. Mature, efficient, and will dominate wide-area wireless systems for the remainder of this decade and well into next.
OFDM/OFDMA	802.16/WiMAX, Flarion Fast Low-Latency Access with Seamless Handoff OFDM (Flash OFDM), 3GPP LTE, IEEE 802.11a/g/n, IEEE 802.20, Third Generation Partnership Project 2 (3GPP2) UMB, 3GPP2 Enhanced Broadcast Multicast Services (EBCMCS), Digital Video Broadcasting-H (DVB-H), Forward Link Only (FLO)	Effective approach for broadcast systems, higher bandwidth radio systems, and high peak data rates in large blocks of spectrum. Also provides flexibility in the amount of spectrum used. Well suited for systems planned for the next decade.

Because OFDMA has only modest advantages over UMTS in 5 MHz channels, the advancement of HSPA is a logical and effective strategy. In particular, it extends the life of operators' large 3G investments reducing overall infrastructure investments, decreasing capital and operational expenditures, and allowing operators to offer competitive services.

3GPP Evolutionary Approach

Rather than emphasizing any one wireless approach, 3GPP's evolutionary plan is to recognize the strengths and weaknesses of every technology and to exploit the unique capabilities of each one accordingly. GSM, based on a TDMA approach, is mature and broadly deployed. Already extremely efficient, there are nevertheless opportunities for additional optimizations and enhancements. Standards bodies have already defined "Evolved EDGE," which will be available for deployment in the 2009 to 2010 timeframe and bring more than a doubling of performance over current EDGE systems. By the end of the decade, because of sheer market momentum, the majority of worldwide subscribers will still be using GSM/EDGE technologies.

Meanwhile, CDMA was chosen as the basis of 3G technologies, including WCDMA for the frequency division duplex (FDD) mode of UMTS, and Time Division CDMA (TD-CDMA) for the time division duplex (TDD) mode of UMTS. The evolved data systems for UMTS, such as HSPA and HSPA+, introduce enhancements and simplifications that help CDMA-based systems match the capabilities of competing systems, especially in 5 MHz spectrum allocations. Over the remainder of this decade, GSM and UMTS will constitute a growing proportion of subscriptions and, by the end of the decade, these technologies will likely account for most new subscriptions.

Given some of the advantages of an OFDM approach, 3GPP has specified OFDMA as the basis of its Long Term Evolution²⁷ effort. LTE incorporates best-of-breed radio techniques to achieve performance levels beyond what will be practical with CDMA approaches, particularly in larger channel bandwidths. However, in the same way that 3G coexists with Second Generation (2G) systems in integrated networks, LTE systems will coexist with both 3G systems and 2G systems. Multimode devices will function across LTE/3G or even LTE/3G/2G, depending on market circumstances. Beyond radio technology, EPC/SAE provides a new core architecture that enables both flatter architectures, and integration of LTE with both legacy GSM/UMTS networks, as well as other wireless technologies. The combination of EPC and EPS is referred to as the Evolved Packet System (EPS).

Though later sections quantify performance, and the appendix of the white paper presents functional details of the different technologies, this section provides a quick summary intended to provide a frame of reference for the subsequent discussion. Table 3 summarizes the key 3GPP technologies and their characteristics.

Table 3: Characteristics of 3GPP Technologies

Technology Name	Type	Characteristics	Typical Downlink Speed	Typical Uplink Speed
GSM	TDMA	Most widely deployed cellular technology in the world. Provides voice and data service via GPRS/EDGE.		
EDGE	TDMA	Data service for GSM networks. An enhancement to original GSM data service	70 kbps to 130 kbps	70 kbps to 130 kbps

²⁷ 3GPP also refers to LTE as Enhanced UMTS Terrestrial Radio Access Network (E-UTRAN).

Technology Name	Type	Characteristics	Typical Downlink Speed	Typical Uplink Speed
		called GPRS.		
Evolved EDGE	TDMA	Advanced version of EDGE that can double and eventually quadruple throughput rates.	150 kbps to 500 kbps expected	100 kbps to 500 kbps expected
UMTS	CDMA	3G technology providing voice and data capabilities. Current deployments implement HSPA for data service.	200 to 300 kbps	200 to 300 kbps
HSPA	CDMA	Data service for UMTS networks. An enhancement to original UMTS data service.	1 Mbps to 4 Mbps	500 kbps to 2 Mbps
HSPA+	CDMA	Evolution of HSPA in various stages to increase throughput and capacity and to lower latency.	>5 Mbps expected	>3 Mbps expected
LTE	OFDMA	New radio interface that can use wide radio channels and deliver extremely high throughput rates. All communications handled in IP domain. Typical user rates may exceed 10 Mbps.	> 10 Mbps expected	> 5 Mbps expected
LTE Advanced	OFDMA	Advanced version of LTE designed to meet IMT-Advanced requirements.		

User achievable rates and greater details on typical rates are covered in Table 5 in the section “Data Throughput” later in this paper. Figure 5 shows the evolution of the different wireless technologies and their peak network performance capabilities.

Figure 5: Evolution of TDMA, CDMA, and OFDMA Systems

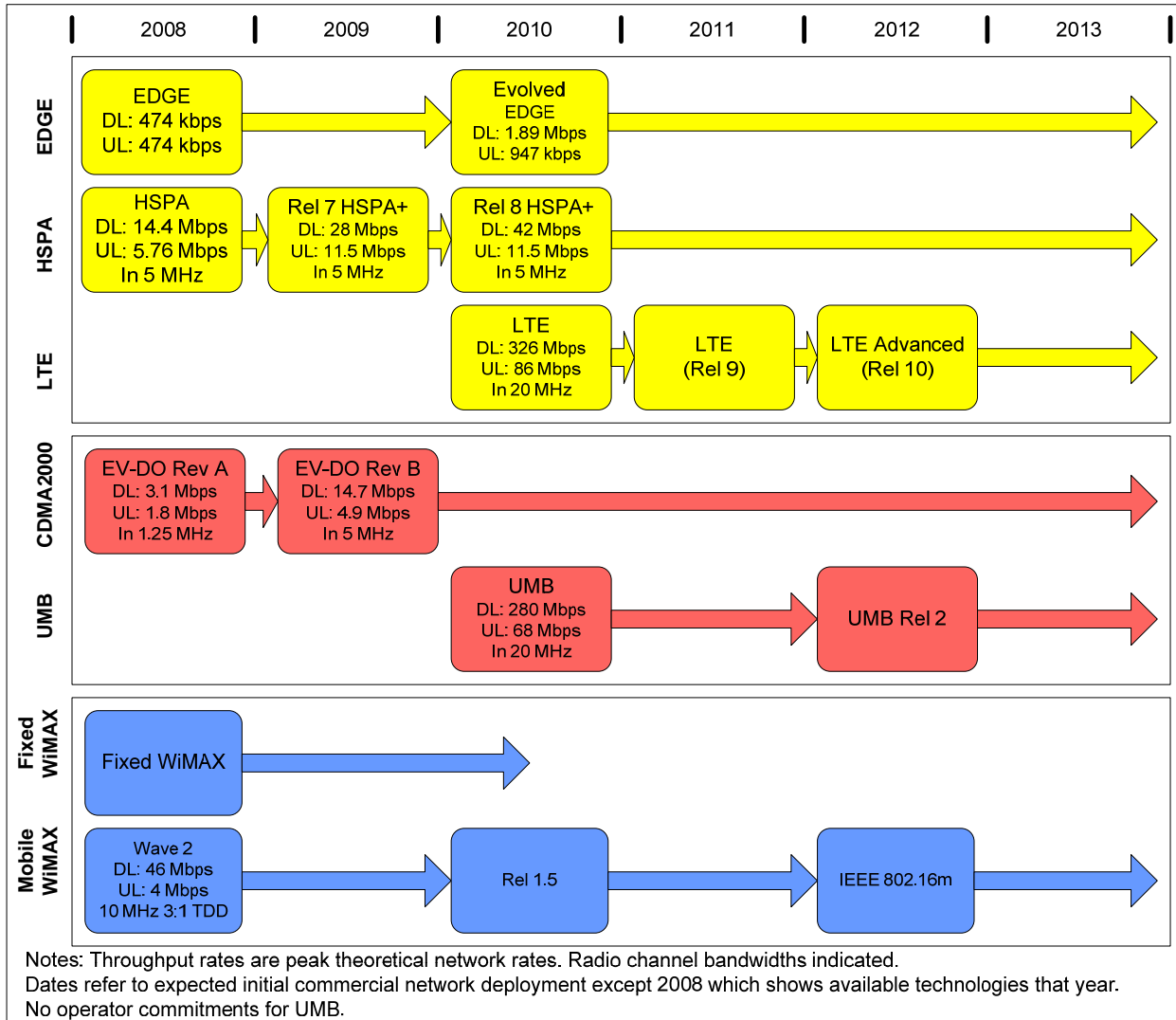

The development of GSM and UMTS/HSPA happens in stages referred to as 3GPP releases, and equipment vendors produce hardware that supports particular versions of each specification. It is important to realize that the 3GPP releases address multiple technologies. For example, Release 7 optimizes VoIP for HSPA but also significantly enhances GSM data functionality with Evolved EDGE. A summary of the different 3GPP releases is as follows:²⁸

- ❑ **Release 99:** Completed. First deployable version of UMTS. Enhancements to GSM data (EDGE). Majority of deployments today are based on Release 99. Provides support for GSM/EDGE/GPRS/WCDMA radio-access networks.
- ❑ **Release 4:** Completed. Multimedia messaging support. First steps toward using IP transport in the core network.

²⁸ After Release 99, release versions went to a numerical designation instead of designation by year.

- ❑ **Release 5:** Completed. HSDPA. First phase of IMS. Full ability to use IP-based transport instead of just Asynchronous Transfer Mode (ATM) in the core network.
- ❑ **Release 6:** Completed. HSUPA. Enhanced multimedia support through Multimedia Broadcast/Multicast Services (MBMS). Performance specifications for advanced receivers. WLAN integration option. IMS enhancements. Initial VoIP capability.
- ❑ **Release 7:** Completed. Provides enhanced GSM data functionality with Evolved EDGE. Specifies HSPA Evolution (HSPA+), which includes higher order modulation and MIMO. Provides fine-tuning and incremental improvements of features from previous releases. Results include performance enhancements, improved spectral efficiency, increased capacity, and better resistance to interference. Continuous Packet Connectivity (CPC) enables efficient “always-on” service and enhanced uplink UL VoIP capacity as well as reductions in call set-up delay for PoC. Radio enhancements to HSPA include 64 QAM in the downlink DL and 16 QAM in the uplink. Also includes optimization of MBMS capabilities through the multicast/broadcast single-frequency network (MBSFN) function.
- ❑ **Release 8:** Under development. Comprises further HSPA Evolution features such as simultaneous use of MIMO and 64 QAM. Includes work item for dual-carrier HSPA (DC-HSPA) where two WCDMA radio channels can be combined for a doubling of throughput performance. Specifies OFDMA-based 3GPP LTE. Defines EPC.
- ❑ **Release 9:** Expected to include HSPA and LTE enhancements.
- ❑ **Release 10:** Expected to specify LTE Advanced that meets the requirements set by ITU’s IMT-Advanced project.

Whereas operators and vendors actively involved in the development of wireless technology are heavily focused on 3GPP release versions, most users of the technology are more interested in particular features and capabilities, such as whether a device supports HSDPA. For this reason, the detailed discussion of the technologies in this paper emphasizes features as opposed to 3GPP releases.

Spectrum

Another important aspect of UMTS/HSPA deployment is the expanding number of available radio bands, as shown in Figure 6, and the corresponding support from infrastructure and mobile-equipment vendors. The fundamental system design and networking protocols remain the same for each band; only the frequency-dependent portions of the radios have to change.

As other frequency bands become available for deployment, standards bodies are adapting UMTS for these bands as well. This includes 450 and 700 MHz. UMTS-TDD equipment is already available for 450 MHz. 1710-1770 uplink was matched with 2110-2170 downlink to allow for additional global harmonization of the 1.7/2.1GHz band. Meanwhile, the Federal Communications Commission auctioned the 700 MHz band in the United States in January 2008. The availability of this band, the Advanced Wireless Services (AWS) band at 1710-1755 MHz with/2110-2155 MHz in the US, and the forthcoming 2.6 GHz frequency band in Europe are providing operators with wider deployment options. An increasing number of operators are also deploying UMTS at 900 MHz, a traditional GSM band.

As the total amount of available spectrum increases and as technologies simultaneously become spectrally more efficient, total capacity rises rapidly, supporting more subscribers, and make many new types of applications feasible.

The following figure shows the FDD bands defined for 3GPP technologies.

Figure 6: FDD Bands for 3GPP Technologies ²⁹

Operating band	Band name	Total spectrum	Uplink [MHz]	Downlink [MHz]
Band 1	2.1 GHz	2x60 MHz	1920-1980	2110-2170
Band 2	1900 MHz	2x60 MHz	1850-1910	1930-1990
Band 3	1800 MHz	2x75 MHz	1710-1785	1805-1880
Band 4	1.7/2.1 GHz	2x45 MHz	1710-1755	2110-2155
Band 5	850 MHz	2x25 MHz	824-849	869-894
Band 6	800 MHz	2x10 MHz	830-840	875-885
Band 7	2.6 GHz	2x70 MHz	2500-2570	2620-2690
Band 8	900 MHz	2x35 MHz	880-915	925-960
Band 9	1700 MHz	2x35 MHz	1749.9-1784.9	1844.9-1879.9
Band 10	Ext 1.7/2.1MHz	2x60 MHz	1710-1770	2110-2170
Band 11	1500 MHz	2x25 MHz	1427.9 - 1452.9	1475.9 - 1500.9
Band 12	Lower 700 MHz	2x18 MHz	698-716	728-746
Band 13	Upper 700 MHz	2x10 MHz	777-787	746-756
Band 14	Upper 700 MHz, public safety/private	2x10 MHz	788-798	758-768

It should be noted that, although the support of a new frequency band may be introduced in a particular release, the 3GPP standard also specifies ways to implement devices and infrastructure operating on any frequency band according to release anterior to the introduction of that particular frequency band. For example, although band 5 (US Cellular Band) was introduced in Release 6, the first devices operating on this band were compliant with the release 5 of the standard.

Figure 7 shows TDD bands defined for 3GPP Technologies.

²⁹ Source: 3G Americas' member company.

Figure 7: TDD Bands for 3GPP Technologies³⁰

Operating band	Total spectrum	Frequencies [MHz]
Band 33	20 MHz	1900-1920
Band 34	15 MHz	2010-2025
Band 35	60 MHz	1850-1910
Band 36	60 MHz	1930-1990
Band 37	20 MHz	1910-1930
Band 38	50 MHz	2570-2620
Band 39	40 MHz	1880-1920
Band 40	100 MHz	2300-2400

Different countries have regulated spectrum more loosely than others. For example, operators in the United States can use either 2G or 3G technologies in cellular, Personal Communications Service (PCS), and 3G bands; whereas in Europe there are greater restrictions—though efforts are underway that are resulting in greater flexibility, including the use of 3G technologies in current 2G bands.

With the projected increase in the use of mobile-broadband technologies, the amount of spectrum required by the next generation of wireless technology (that is, after 3GPP LTE in projects such as International Mobile Telecommunications (IMT) Advanced) could be substantial, given the desire to operate radio channels as wide as 100 MHz. Ideally, this spectrum would fall below 5 GHz. This search for new spectrum is a long-term undertaking, and it may be well into the next decade before any such new spectrum becomes available. However, given the expanding size and economic significance of the mobile-computing industry, decisions made on new spectrum—especially with respect to global harmonization—will have profound consequences.

Core-Network Evolution

3GPP is defining a series of enhancements to the core network to improve network performance and the range of services provided and to enable a shift to all-IP architectures.

One way to improve core-network performance is by using flatter architectures. The more hierarchical a network, the more easily it can be managed centrally; however, the tradeoff is reduced performance, especially for data communications, because packets must traverse and be processed by multiple nodes in the network. To improve data performance and, in particular, to reduce latency (delays), 3GPP has defined a number of enhancements in Release 7 and Release 8 that reduce the number of processing nodes and result in a flatter architecture.

³⁰ Source: 3G Americas' member company.

In Release 7, an option called one-tunnel architecture allows operators to configure their networks so that user data bypasses a serving node and travels directly via a gateway node. There is also an option to integrate the functionality of the radio-network controller directly into the base station.

For Release 8, 3GPP has defined an entirely new core network, called the Evolved Packet Core, previously called System Architecture Evolution. The key features and capabilities of EPC/SAE include:

- ❑ Reduced latency and higher data performance through a flatter architecture.
- ❑ Support for both LTE radio-access networks and interworking with GSM/UMTS radio-access networks.
- ❑ The ability to integrate non-3GPP networks such as WiMAX.
- ❑ Optimization for all services provided via IP.

This paper provides further details in the sections on HSPA Evolution (HSPA+) and EPC/SAE.

Service Evolution

Not only do 3GPP technologies provide continual improvements in capacity and data performance, they also evolve capabilities that expand the services available to subscribers. Key service advances include FMC, IMS, and broadcasting technologies. This section provides an overview of these topics, and the appendix provides greater detail on each of these items.

FMC refers to the integration of fixed services (such as telephony provided by wireline or Wi-Fi) with mobile cellular-based services. Though FMC is still in its early stages of deployment by operators, it promises to provide significant benefits to both users and operators. For users, FMC will simplify how they communicate, making it possible for them to use one device (for example, a cell phone) at work and at home, where it might connect via a Wi-Fi network or a femto cell. When mobile, users connect via a cellular network. Users will also benefit from single voice mailboxes and single phone numbers as well as the ability to control how and with whom they communicate. For operators, FMC allows the consolidation of core services across multiple-access networks. For instance, an operator could offer complete VoIP-based voice service that supports access via DSL, Wi-Fi, or 3G. FMC also offloads the macro network from data-intensive applications such as movie downloads.

FMC has various approaches, including enabling technologies such as Unlicensed Mobile Access (UMA), femtocells, and IMS. With UMA, GSM/UMTS devices can connect via Wi-Fi or cellular connections for both voice and data. UMA is a 3GPP technology, and it has been deployed by a number of operators, including T-Mobile in the United States. An alternative to using Wi-Fi for the “fixed” portion of FMC is femtocells. These are tiny base stations that cost little more than a Wi-Fi access point and, like Wi-Fi, femtocells leverage a subscriber’s existing wireline-broadband connection (for example, DSL). Instead of operating on unlicensed bands, femtocells use the operator’s licensed bands at very low power levels. The key advantage of the femto cell approach is that any single-mode, mobile-communications device a user has can now operate using the femto cells.

IMS is another key technology for convergence. It allows access to core services and applications via multiple-access networks. IMS is more powerful than UMA, because it supports not only FMC but also a much broader range of potential applications. In the

United States, AT&T has committed to an IMS approach and has already deployed an IMS-based video sharing service. Though defined by 3GPP, the Third Generation Partnership Project 2 (3GPP2), CableLabs and WiMAX have adopted IMS.

IMS allows the creative blending of different types of communications and information, including voice, video, IM, presence information, location, and documents. It provides application developers the ability to create applications that have never before been possible, and it allows people to communicate in entirely new ways by dynamically using multiple services. For example, during an interactive chat session, a user could launch a voice call. Or during a voice call, a user could suddenly establish a simultaneous video connection or start transferring files. While browsing the Web, a user could decide to speak to a customer-service representative. IMS will be a key platform for all-IP architectures for both HSPA and LTE.

Another important new service is support for mobile TV through what is called multicast or broadcast functions. 3GPP has defined multicast/broadcast capabilities for both HSPA and LTE.

Broadband-Wireless Deployment Considerations

Much of the debate in the wireless industry is on the merits of different radio technologies, yet other factors are equally important in determining the services and capabilities of a wireless network. These factors include the amount of spectrum available, backhaul, and network topology.

Spectrum has always been a major consideration for deploying any wireless network, but it is particularly important when looking at high-performance broadband systems. HSPA and HSPA+ can deliver high throughput rates on the downlink and uplink with low latency in 5 MHz channels when deployed in single frequency (1/1) reuse. By this, we mean that every cell sector (typically three per cell) in every cell uses the same radio channel(s).

As previously discussed, an OFDMA approach in a 5 MHz radio channel yields only a small performance advantage. To achieve higher data rates requires wider radio channels, such as 10 or 20 MHz wide channels in combination with emerging OFDMA radio technologies. Very few operators today, however, have access to this much spectrum. It was challenging enough for GSM operators to obtain UMTS spectrum. If delivering very high data rates is the objective, then the system must minimize interference. This result is best achieved by employing looser reuse, such as having every sector use only one-third of the available radio channels (1/3 reuse). The 10 MHz radio channel could now demand as much as 30 MHz of available spectrum.

Backhaul is another factor. As the throughput of the radio link increases, the circuits connecting the cell sites to the core network must be able to handle the increased load. With many cell sites today serviced by just a small number of T1/E1 circuits, each able to carry only 1.5/2.0 Mbps, operators will have to significantly upgrade backhaul capacity to obtain the full benefit of next-generation wireless technologies. An OFDMA system with 1.5 bps per hertz (Hz) of spectral efficiency in 10 MHz on three sectors has up to 45 Mbps average cell throughput.

Additionally, any technology's ability to reach its peak spectrum efficiency is somewhat contingent on the system's ability to reach the instantaneous peak data rates allowed by that technology. For example, a system claiming spectrum efficiency of 1.5 bps/Hz (as described above) might rely on the ability to reach 100 Mbps instantaneously to achieve this level of spectrum efficiency. Any constraint on the transport system below 100 Mbps

will restrict the range of achievable throughput and, in turn, impact the spectral efficiency of the system.

The mismatch between backhaul capabilities and radio performance in some networks is one reason that user rates on some 3G systems are lower than theoretical rates. Operators are actively enhancing their backhaul approaches, and there are many available and emerging wireline technologies—such as VDSL and optical Ethernet—as well as competitive point-to-point microwave systems that make this possible.

Finally, the overall network topology also plays an important role, especially with respect to latency. Low latency is critical to achieving very high data rates, because of the way it affects TCP/IP traffic. How traffic routes through the core network—how many hops and nodes it must pass through—can influence the overall performance of the network. One way to increase performance is by using flatter architectures, meaning a less hierarchical network with more direct routing from mobile device to end system. The core EPC/SAE network for 3GPP LTE emphasizes such a flatter architecture.

In summary, it can be misleading to say that one wireless technology outperforms another without a full understanding of how that technology will be deployed in a complete system that also takes spectrum into account.

Feature and Network Roadmap

GSM operators first enhanced their networks to support data capability through the addition of GPRS infrastructure with the ability to use existing cell sites, transceivers, and interconnection facilities. Since installing GPRS, GSM operators have largely upgraded data service to EDGE, and any new GSM network includes EDGE capability.

Operators have deployed UMTS/HSPA worldwide. Although UMTS involves a new radio-access network, several factors facilitate deployment. First, most UMTS cell sites can be collocated in GSM cell sites enabled by multi-radio cabinets that can accommodate GSM/EDGE as well as UMTS equipment. Second, much of the GSM/GPRS core network can be used. This means that all core-network elements above the Serving GPRS Support Node (SGSN) and Mobile Switching Center (MSC)—the Gateway GPRS Support Node (GGSN), the Home Location Register (HLR), billing and subscriber administration systems, service platforms, and so forth—need, at most, a software upgrade to support 3G UMTS/HSPA. And while early 3G deployment used separate 2G/3G SGSNs and MSCs, all-new MSC and/or SGSN products are capable of supporting both GSM and UMTS/HSPA radio-access networks.

New features such as HSDPA, HSUPA, and MBMS are being designed so that the same upgraded UMTS radio channel can support a mixture of terminals including those based on 3GPP Release 99, Release 5, and Release 6. In other words, a network supporting Release 5 features (for example, HSDPA) can support Release 99, Release 5, and Release 6 terminals (for example, HSUPA) operating in a Release 5 mode. Alternatively, a network supporting Release 6 features can support Release 99, Release 5, and Release 6 terminals. This flexibility assures the maximum degree of forward- and backward-compatibility. Note also that most UMTS terminals today support GSM, thus facilitating use across large coverage areas and multiple networks.

Once deployed, operators can minimize the costs of managing GSM/EDGE and UMTS networks, because these networks share many of the same aspects including:

- ❑ Packet-data architecture
- ❑ Cell sites

- ❑ Antenna systems
- ❑ Backhaul circuits
- ❑ Subscriber account management
- ❑ Service platforms

Users largely don't even need to know to what type of network they are connected, because their multimode GSM/UMTS devices can seamlessly hand off between networks.

The changes being planned for the core network are another aspect of evolution. Here, the intent is to reduce the number of nodes that packets must traverse. This will result in both reduced deployment costs and reduced latency. The key enabling technology is EPC/SAE, which is described in detail later in this paper.

The upgrade to LTE will be relatively straightforward, with new infrastructure supporting HSPA, but software upgradeable to HSPA+ and LTE. Beginning at the end of 2008, UMTS/HSPA base stations from some vendors will have LTE software upgrades available by the second half of 2009. Base station equipment is available for many bands including the 1.7/2.1 GHz AWS band and the recently auctioned 700 MHz bands in the US. Vendors and operators are planning LTE field trials in 2008-09 and commercial deployments by 2010.

On the device side, multi-mode chipsets will enable devices to easily operate across UMTS and LTE networks. For example, one chipset vendor has announced a series of chips that support the following combination of technologies: UMTS, HSPA+ and LTE; EV-DO Rev B, UMB and LTE; and UMTS, HSPA+, EV-DO Rev B, UMB and LTE.³¹

One important and interesting aspect of technology deployment is that an advanced technology such as LTE enables operators to upgrade prior technologies, such as HSPA. Examples include:

- ❑ VoIP for HSPA. Since LTE uses an IP core, once it is deployed, supporting voice on HSPA via VoIP will be a much simpler task as it can share the same core IP network as LTE.
- ❑ Device processing power. Supporting the high throughput rates with LTE (e.g., 50 Mbps or higher) will provide sufficient processing in the device to also support very high HSPA rates (e.g., 30 Mbps or higher).

Table 4 shows the rollout of EDGE/HSPA/LTE features over time.

Table 4: Expected UMTS/LTE Feature and Capability Availability

Year	Features
2008	<p>HSUPA seeing significant deployment momentum in networks and device availability.</p> <p>First HSUPA networks with 5.8 Mbps peak uplink speed capability.</p> <p>HSPA devices with 7.2 Mbps downlinks widely available.</p> <p>Various operators offering FMC based on UMA.</p> <p>Operators announcing commitments to femto cell approaches.</p>

³¹ http://www.qualcomm.com/press/releases/2008/080207_Qualcomm_to_Ship.html

Year	Features
	Greater availability of FMC
2009	<p>Networks and devices capable of Release 7 HSPA+, including MIMO, boosting HSPA peak speeds to 28 Mbps</p> <p>Enhanced IMS-based services (for example, integrated voice/multimedia/presence/location)</p>
2010	<p>Evolved EDGE capabilities available to significantly increase EDGE throughput rates</p> <p>HSPA+ peak speeds further increased to peak rates of 42 Mbps based on Release 8</p> <p>LTE introduced for next-generation throughput performance using 2X2 MIMO</p> <p>Advanced core architectures available through EPC/SAE, primarily for LTE but also for HSPA+, providing benefits such as integration of multiple network types and flatter architectures for better latency performance</p> <p>Most new services implemented in the packet domain over HSPA+ and LTE</p>
2011 and later	<p>LTE enhancements such as 4X2 MIMO and 4X4 MIMO</p> <p>LTE Advanced specifications completed.</p>
2012	LTE Advanced potentially deployed in initial stages.

Over time, the separate GSM/EDGE Access Network (GERAN), UMTS Access Network (UTRAN), and core-infrastructure elements will undergo consolidation, thus lowering total network cost and improving integrated operation of the separate access networks. For actual users with multimode devices, the networks they access will be largely transparent. Today, nearly all UMTS phones and modems support GSM /EDGE.

Figure 8 presents the continuing advances in HSPA and LTE, plotted over time, showing an approximate doubling of throughput per year.

Figure 8: Peak Rates for Downlink and Uplink Over Time³²

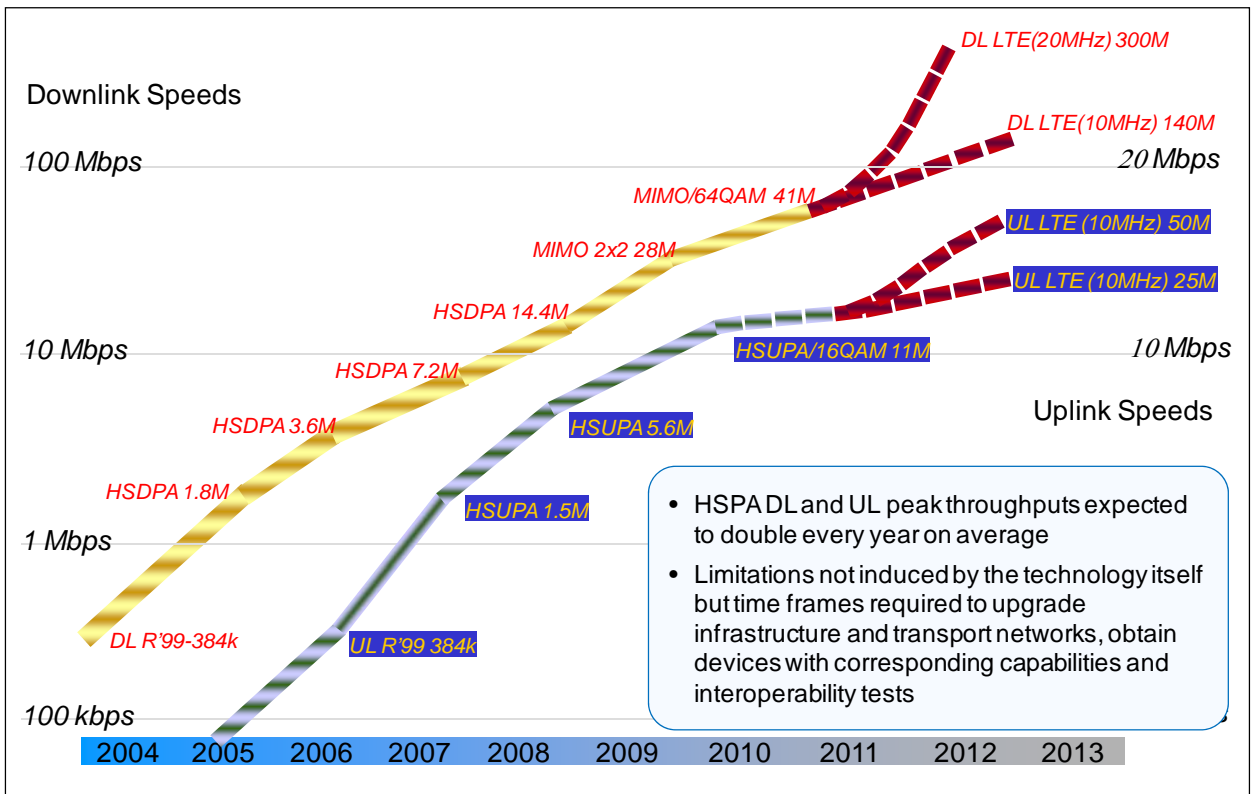

Despite rapid UMTS deployment, market momentum means that even by the end of the decade most worldwide subscribers will still be using GSM. By then, however, most new subscribers will be taking advantage of UMTS. Only over many years, as subscribers upgrade their equipment, will most network usage migrate to UMTS. Similarly, even as operators start to deploy LTE networks at the end of this decade and the beginning of the next, it will probably be the middle of the next decade before a large percentage of subscribers are actually using LTE. During these years, most networks and devices will be tri-mode—supporting GSM, UMTS, and LTE. The history of wireless-network deployment provides a useful perspective. GSM, which in 2008 is still growing its subscriber base, was specified in 1990, with initial networks deployed in 1991. The UMTS Task Force established itself in 1995, Release 99 specifications were completed in 2000, and HSPA+ specifications were completed in 2007. Although it's been more than a decade since work began on the technology, only now is UMTS deployment and adoption starting to surge.

Figure 9 shows the relative adoption of technologies over a multi-decadal period and the length of time it takes for any new technology to be adopted widely on a global basis.

³² Source: 3G Americas' member company.

Figure 9: Relative Adoption of Technologies³³

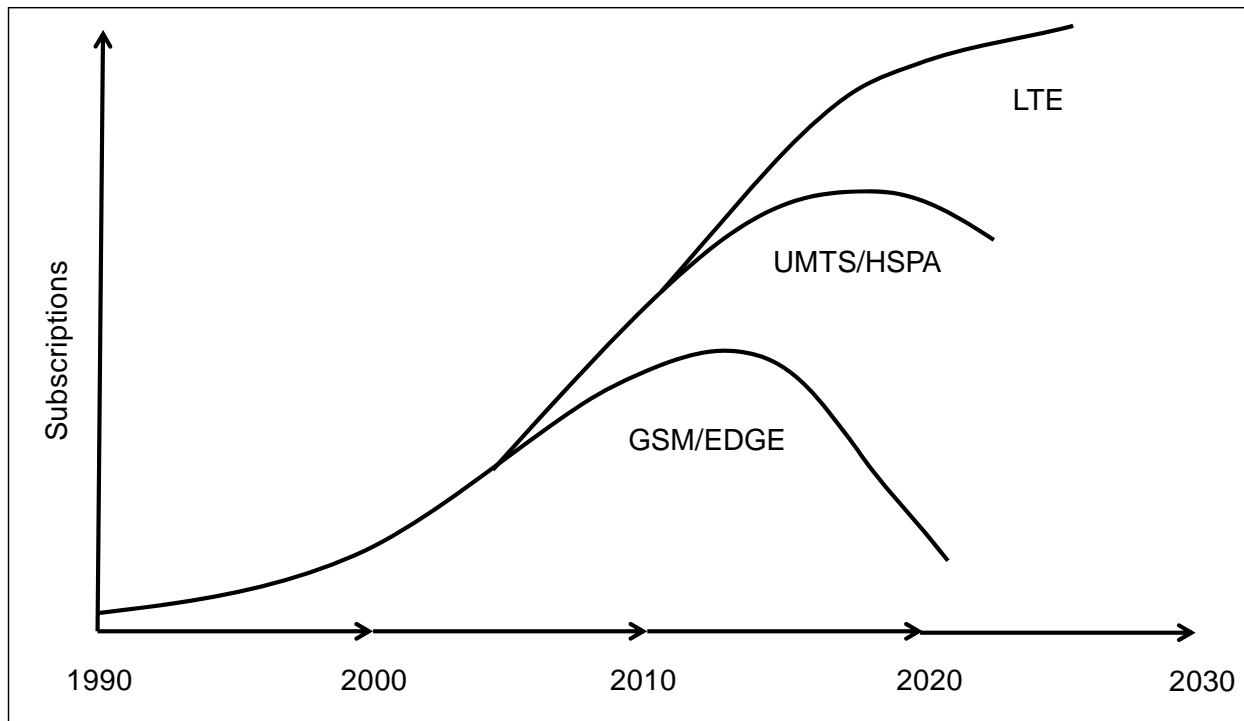

One option for GSM operators that have not yet committed to UMTS, and do not have an immediate pressing need to do so, is to migrate directly from GSM/EDGE or Evolved EDGE to LTE with networks and devices supporting dual-mode GSM-EDGE/LTE operation.

Competing Technologies

Although GSM/GPRS/EDGE/UMTS/HSPA networks are dominating global cellular-technology deployments, operators are deploying other wireless technologies to serve both wide and local areas. This section of the paper looks at the relationship between GSM/UMTS/LTE and some of these other technologies.

CDMA2000

CDMA2000, consisting principally of 1xRTT and One Carrier-Evolved, Data-Optimized (1xEV-DO) versions, is the other major cellular technology deployed in many parts of the world. 1xRTT is currently the most widely deployed CDMA2000 version. A number of operators have deployed or are deploying 1xEV-DO, where a radio carrier is dedicated to high-speed data functions. In July 2008 there were 100 EV-DO Release 0 networks and 42 EV-DO Rev A networks deployed worldwide.³⁴

³³ Source: Rysavy Research projection based on historical data.

³⁴ Source: www.cdg.org, July 14, 2008.

EV-DO uses many of the same techniques for optimizing spectral efficiency as HSPA, including higher order modulation, efficient scheduling, turbo-coding, and adaptive modulation and coding. For these reasons, it achieves spectral efficiency that is virtually the same as HSPA. The 1x technologies operate in the 1.25 MHz radio channels, compared to the 5 MHz channels UMTS uses. This results in lower theoretical peak rates, but average throughputs for high level of network loading are similar. Under low to medium-load conditions, because of the lower peak achievable data rates, EV-DO or EV-DO Rev A achieves a lower typical performance level than HSPA. Operators have quoted 400 to 700 kilobits per second (kbps) typical downlink throughput for EV-DO Rev 0³⁵ and between 600 kbps and 1.4 Mbps for EV-DO Rev A.³⁶

Under low to medium load conditions, because of the lower peak achievable data rates, EV-DO or EV-DO Rev A achieve a slightly lower typical performance level than HSPA.

Currently deployed network versions are based on either Rev 0 or Rev A radio-interface specifications. EV-DO Rev A incorporates a more efficient uplink, which has spectral efficiency similar to that of HSUPA. Operators started to make EV-DO Rev A commercially available in 2007.

One challenge for EV-DO operators is that they cannot dynamically allocate their entire spectral resources between voice and high-speed data functions. The EV-DO channel is not available for circuit-switched voice, and the 1xRTT channels offer only medium-speed data. In the current stage of the market, where data only constitutes a small percentage of total network traffic, this is not a key issue. But as data usage expands, this limitation will cause suboptimal use of radio resources. Figure 10 illustrates this severe limitation.

³⁵ Source: Verizon BroadbandAccess Web page, July 29, 2005.

³⁶ Source: Sprint press release January 30, 2007.

Figure 10: Radio Resource Management 1xRTT/1xEV-DO versus UMTS/HSPA

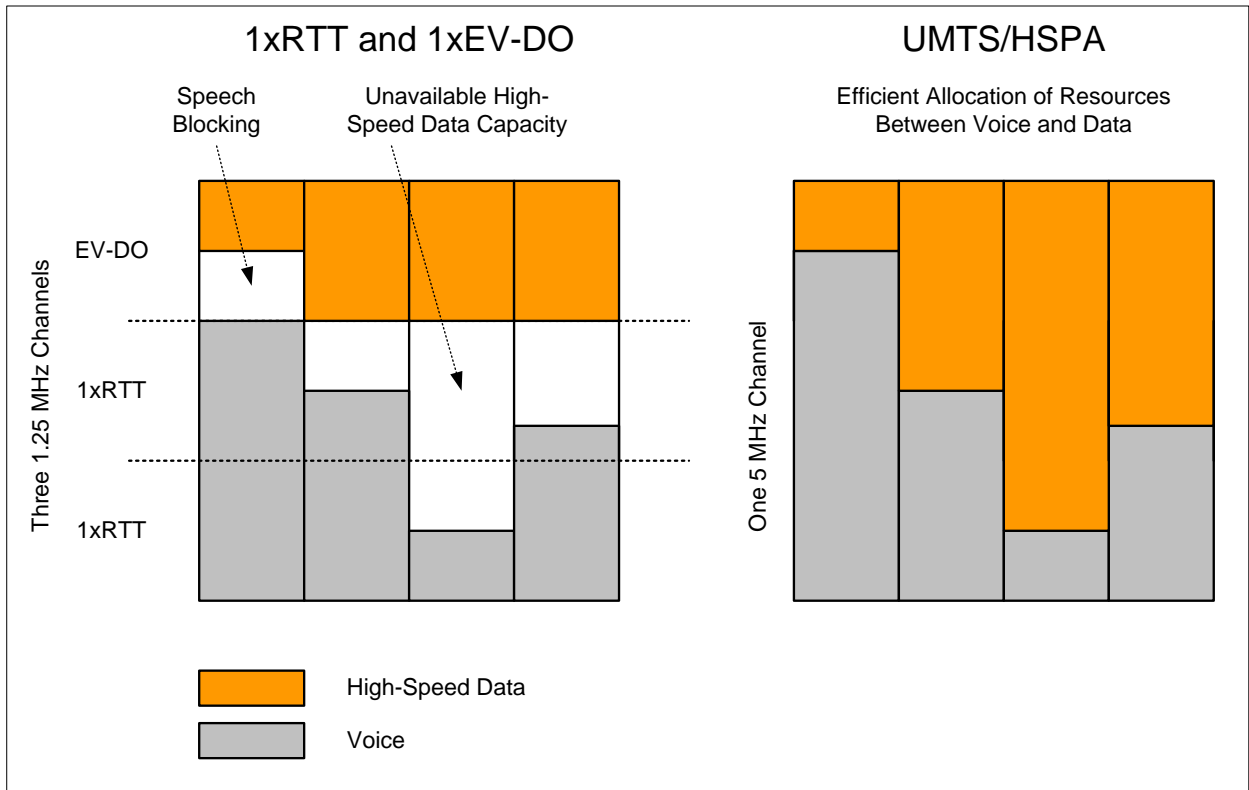

Another limitation of using a separate channel for EV-DO data services is that it currently prevents users from engaging in simultaneous voice and high-speed data services, whereas this is possible with UMTS and HSPA. Many users enjoy having a tethered data connection from their laptop—by using Bluetooth, for example—and being able to initiate and receive phone calls while maintaining their data sessions.

EV-DO will eventually provide voice service using VoIP protocols through EV-DO Rev A, which includes a higher speed uplink, QoS mechanisms in the network, and protocol optimizations to reduce packet overhead, as well as addressing problems such as jitter.

Even then, however, operators will face difficult choices: How many radio channels at each base station should be made available for 1xRTT to support legacy terminals versus how many radio channels should be allocated to EV-DO. In contrast, UMTS allows both circuit-switched and packet-switched traffic to occupy the same radio channel, where the amount of power each uses can be dynamically adjusted. This makes it simple to migrate users over time from circuit-switched voice to packet-switched voice.

Beyond Rev A, 3GPP2 has defined EV-DO Rev B as allowing the combination of up to 15 1.25 MHz radio channels in 20 MHz—significantly boosting peak theoretical rates to 73.5 Mbps. More likely, an operator would combine three radio channels in 5 MHz. Such an approach by itself does not necessarily increase overall capacity, but it does offer users higher peak-data rates. No operators have yet publicly committed to EV-DO Rev B.

Beyond Rev B, UMB will be based on an OFDMA approach like LTE. UMB supports radio channels from 1.25 to 20 MHz. In a 20 MHz radio channel, using 4X4 MIMO, UMB will deliver a peak-data rate of 280 Mbps. UMB and LTE are being developed basically simultaneously, so it is logical to assume that both technologies will exploit the same advances in wireless technology. Both UMB and LTE are more recent than other OFDMA

technologies, like WiMAX, so it is also logical to assume that their capabilities will exceed initial OFDMA designs.

No operators have committed to UMB, and there are legitimate questions about the commercial viability of the technology as more CDMA2000 operators such as Verizon choose LTE as their next technology choice. Though the migration from CDMA2000 to LTE is feasible, it will be more complex than for UMTS/HSPA operators, especially in achieving interworking between LTE and legacy networks.

CDMA2000 is clearly a viable and effective wireless technology and, to its credit, many of its innovations have been brought to market ahead of competing technologies. Today, however, the GSM family of technologies—including UMTS—adds more customers in one year than the entire base of CDMA2000 customers. And the GSM family has in excess of 3.6 billion subscribers—more than nine times the total number of subscribers as the CDMA2000 family of technologies.³⁷

WiMAX

WiMAX has emerged as a potential alternative to cellular technology for wide-area wireless networks. Based on OFDMA and recently accepted by the International Telecommunications Union (ITU) as an IMT-2000 (3G technology) under the name OFDMA TDD WMAN (Wireless Metropolitan Area Network), WiMAX is trying to challenge existing wireless technologies—promising greater capabilities and greater efficiencies than alternative approaches such as HSPA. But as WiMAX, particularly mobile WiMAX, has come closer to reality, vendors have continued to enhance HSPA, and perceived WiMAX advantages are no longer apparent. Instead, WiMAX has gained the greatest traction in developing countries as an alternative to wireline deployment. In the United States, Clearwire, Sprint Nextel and others (Intel, Google, Comcast, Time Warner Cable, Bright House Networks) have created a joint venture to deploy a nationwide WiMAX network that is awaiting United States Regulatory Approval. In addition, at the time of this paper, there are still no wide area deployments of WiMAX in the US. At best, the promises of mobile WiMAX is appealing but it remains unproven in the real world.

Like GSM/HSPA, WiMAX is not a single technology; it is a family of interoperable technologies. The original specification, IEEE 802.16, was completed in 2001 and intended primarily for telecom backhaul applications in point-to-point, line-of-sight configurations using spectrum above 10 GHz. This original version of IEEE 802.16 uses a radio interface based on a single-carrier waveform.

The next major step in the evolution of IEEE 802.16 occurred in 2004, with the release of the IEEE 802.16-2004 standard. It added multiple radio interfaces, including one based on OFDM-256 and one based on OFDMA. IEEE 802.16-2004 also supports point-to-multipoint communications, sub-10 GHz operation, and non-line-of-sight communications. Like the original version of the standard, operation is fixed, meaning that subscriber stations are typically immobile. Potential applications include wireless Internet Service Provider (ISP) service, local telephony bypass (as an alternative to cable modem or DSL service), and cellular backhaul for connections from cellular base stations to operator infrastructure networks. Vendors can design equipment for either licensed or unlicensed bands.

Vendors are now delivering IEEE 802.16-2004-certified equipment. This standard does not compete directly with cellular-data and private Wi-Fi networks; thus, it can provide

³⁷ Source: Informa Telecoms & Media, World Cellular Information Service, June 2008.

complementary services. In addition to operator-hosted access solutions, private entities such as municipal governments, universities, and corporations will be able to use this version of WiMAX in unlicensed bands (for example, 5.8 GHz) for local connectivity, though there has been little or no development in this area.

The IEEE has also completed a mobile-broadband standard—IEEE 802.16e-2005—that adds mobility capabilities including support for radio operation while mobile, handovers across base stations, and handovers across operators. Unlike IEEE 802.16-2004, which operates in both licensed and unlicensed bands, IEEE 802.16e-2005 (referred to as mobile WiMAX) makes the most sense in licensed bands. Operators have begun limited mobile WiMAX network deployments in 2008. Current WiMAX profiles emphasize TDD operation. Mobile WiMAX networks are not backward-compatible with IEEE 802.16-2004 networks.

Initial mobile WiMAX networks will be deployed using 2X2 MIMO, TDD and 10 MHz radio channels in a profile defined by the WiMAX Forum known as WiMAX Wave 2. Beyond Wave 2, WiMAX vendors are defining a new IEEE 802.16e-2005 profile called WiMAX Release 1.5, with product certification expected by the end of 2009. Mobile WiMAX release 1.5 includes various refinements intended to improve efficiency and performance, and will be available for deployment in a similar timeframe as LTE. The subsequent version, Mobile WiMAX 2.0, will be designed to address the performance requirements being developed in the ITU IMT-Advanced Project, and will be standardized in a new IEEE standard, IEEE 802.16m. According to Sprint Nextel, IEEE 802.16m will be available in 2011.³⁸

IEEE 802.16e-2005 employs many of the same mechanisms as HSPA to maximize throughput and spectral efficiency, including high-order modulation, efficient coding, adaptive modulation and coding, and Hybrid Automatic Repeat Request (HARQ). The principal difference from HSPA is IEEE 802.16e-2005's use of OFDMA. As discussed in the section "Technical Approaches (TDMA, CDMA, OFDMA)" above, OFDM provides a potential implementation advantage for wide radio channels (for example, 10 to 20 MHz). In 5 to 10 MHz radio channels, there is no evidence indicating that IEEE 802.16e-2005 will have any performance advantage compared to HSPA+.

It should be noted, however, that IEEE 802.16e-2005 contains some aspects that may limit its performance, particularly in scenarios in which a sector contains a large number of mobile users. The performance of the MAC layer is inefficient when scheduling large numbers of users, and some aspects—such as power control of the mobile station—are provided using MAC signaling messages rather than the fast power control used in WCDMA and other technologies. Thus, while WiMAX uses OFDMA, the performance will likely be somewhat less than HSPA due to increased overhead and other design issues.

Relative to LTE, WiMAX has the following technical disadvantages: 5 msec frames instead of 1 msec frames, Chase combining instead of incremental redundancy, coarser granularity for modulation and coding schemes and vertical coding instead of horizontal coding.³⁹ One deployment consideration is that TDD requires network synchronization. It is not possible for one cell site to be transmitting and an adjacent cell site to be receiving at the same time. Different operators in the same band must either coordinate their networks or have guard bands to ensure that they don't interfere with each other.

³⁸ Ali Tabassi, Sprint Nextel, Fierce Wireless Webcast, "WiMAX: Mobilizing the Internet", March 5, 2008.

³⁹ IEEE International Symposium on Personal, Indoor and Mobile Radio Communications: Anders Furuskär et al "The LTE Radio Interface – Key Characteristics and Performance", 2008.

This may introduce problems as more operators introduce networks in the same spectrum band; for example, the 2.5 GHz band in the United States may be used for both TDD and FDD operation.

Although IEEE 802.16e exploits significant radio innovations similar to HSPA+ and LTE, it faces challenges such as economies of scale and technology maturity. Very few operators today have access to spectrum for WiMAX that would permit them to provide widespread coverage.

In reference to economies of scale, GSM/UMTS/HSPA subscribers number in the billions. Even over the next five years, the number of WiMAX subscribers is likely to be quite low. Forward Concepts predicted in January 2008 38 million WiMAX subscribers in 2012⁴⁰ and Juniper Research predicted in May 2008 more than 47 million subscribers by 2013.⁴¹ This matches forecasts from a year ago when Arthur D. Little summarized different forecasts for total WiMAX subscribers worldwide as between 20 million and 100 million by 2012,⁴² a tiny fraction of global wireless subscribers. Senza Fili Consulting projected 54 million WiMAX subscribers by 2012 with emerging markets driving growth.⁴³ To put this into perspective, the GSM family of technologies adds more subscribers every four months (about 100 million) than the expected worldwide total subscriber prediction of WiMAX by 2012.

Finally, from a technology standpoint, mobile WiMAX on paper may be slightly more capable than today's available versions of HSPA. But by the time it becomes available, mobile WiMAX will actually have to compete against evolved HSPA systems that will offer both similar capabilities and enhanced performance. Further, by then, LTE will not be that far from deployment.

One specific area where WiMAX has a technical disadvantage is cell size. In fact, 3G systems have a significant link budget advantage over mobile WiMAX because of soft-handoff diversity gain and an FDD duplexing advantage over TDD.⁴⁴ Arthur D. Little reports that the radii of typical HSPA cells will be two to four times greater than typical mobile WiMAX cells for high-throughput operation.⁴⁵ One vendor estimates that for the same power output, frequency, and capacity, mobile WiMAX requires 1.7 times more cell sites than HSPA.⁴⁶ Given that many real world deployments of HSPA will occur at frequencies such as 850 MHz, and LTE at 700 MHz, WiMAX deployments at 2.5 GHz will be at a significant disadvantage.

With respect to spectral efficiency, WiMAX is comparable to HSPA+, as discussed in the section "Spectral Efficiency" that follows. As for data performance, HSPA+ in Release 8—

⁴⁰ "WiMAX '08 The 3G+ Broadband Alternative", <http://www.fwdconcepts.com/WiMAX8.htm>

⁴¹ <http://www.rcrnews.com/apps/pbcs.dll/article?AID=/20080509/SUB/940077592/1008/newsletter32>

⁴² Source: "HSPA and mobile WiMax for Mobile Broadband WirelessAccess", 27 March 2007, Arthur D. Little Limited.

⁴³ Source: Press release of June 19, 2007 describing the report "WiMAX: Ambitions and Reality. A detailed market assessment and forecast at the global, regional and country level (2006-2012)"

⁴⁴ With a 2:1 TDD system, the reverse link only transmits one third of the time. To obtain the same cell edge data rates, the mobile system must transmit at 4.77 dB higher transmit power.

⁴⁵ Source: "HSPA and mobile WiMax for Mobile Broadband WirelessAccess", 27 March 2007, Arthur D. Little Limited.

⁴⁶ Source: Ericsson public white paper, "HSPA, the undisputed choice for mobile broadband, May 2007".

with a peak rate of 42 Mbps—exceeds mobile WiMAX in 10 MHz in TDD 2:1 DL:UL using 2X2 MIMO of 40 Mbps.⁴⁷ The sometimes-quoted peak rate of 63.4 Mbps for mobile WiMAX in 10 MHz assumes no bandwidth applied to the uplink.

Some have cited intellectual property rights as an area where WiMAX has an advantage. There is little substantial, publicly available information, however to support such claims. First, the large HSPA vendors have invested heavily in these technologies—hopefully giving them significant leverage with which to negotiate reasonable intellectual property rights (IPR) rates with other vendors. Second, the mobile WiMAX industry is in its infancy, and there is considerable lack of clarity when it comes to how different companies will assert and resolve IPR issues.

Finally, wireless-data business models must also be considered. Today's cellular networks can finance the deployment of data capabilities through a successful voice business. Building new networks for broadband wireless mandates substantial capacity per subscriber. Consumers who download 1 gigabyte of data each month represent a ten times greater load on the network than a 1,000-minute-a-month voice user. And if the future is in multimedia services such as movie downloads, it is important to recognize that downloading a single DVD-quality movie—even with advanced compression—consumes approximately 2 gigabytes. It is not clear how easily the available revenue per subscriber will be able to finance large-scale deployment of network capacity. Despite numerous attempts, no terrestrial wireless-data-only network has ever succeeded as a business.⁴⁸ Although there is discussion of providing voice services over WiMAX using VoIP, mobile-voice users demand ubiquitous coverage—including indoor coverage. Matching the cellular footprint with WiMAX will require national roaming arrangements, complemented by new dual-technology devices, or significant operator investments.

IEEE 802.20

IEEE 802.20 is a mobile-broadband specification developed by the Mobile Broadband Wireless Access Working Group of the IEEE that was completed in 2008. With vendors focused heavily on LTE, UMB, and WiMAX for next-generation wireless services, it is not clear whether there is sufficient momentum in this standard to make it a viable technology. At this time, no operator has committed to the possible standard. Note that 802.20 is very similar to UMB. However, neither technology has gained any momentum at this point in time.

Wi-Fi and Municipal Wi-Fi Systems

In the local area, the IEEE 802.11 family of technologies has experienced rapid growth, mainly in private deployments. The latest 802.11 standard, 802.11n offers users throughputs in excess of 100 Mbps, and improved range through use of MIMO. Complementary standards increase the attraction of the technology. 802.11e provides quality-of-service enabling VoIP and multimedia, and 802.11i enables robust security.

Leveraging this success, operators—including cellular operators—are offering hotspot service in public areas such as airports, fast-food restaurants, and hotels. For the most part, hotspots are complementary with cellular-data networks, because the hotspot can

⁴⁷ Source: Ericsson public white paper, "HSPA, the undisputed choice for mobile broadband, May 2007".

⁴⁸ Source: Andy Seybold, January 18, 2006, commentary: "Will Data-Only Networks Ever Make Money?" <http://www.outlook4mobility.com/commentary2006/jan1806.htm>

provide broadband services in extremely dense user areas and the cellular network can provide broadband services across much larger areas. Various organizations are looking at integrating WLAN service with GSM/UMTS data services. The GSM Association has developed recommendations for SIM-based authentication of hotspots, and 3GPP has multiple initiatives that address WLAN integration into its networks, including 3GPP System to WLAN Interworking, UMA, IMS, and EPC/SAE.

Many cities are now deploying metro Wi-Fi systems that will provide Wi-Fi access in downtown areas. These systems are based on a mesh technology, where access points forward packets to nodes that have backhaul connections. Although some industry observers are predicting that these systems will have an adverse effect on 3G data services, metro Wi-Fi and 3G are more likely to be complementary in nature. Wi-Fi can generally provide better application performance over limited coverage areas, whereas 3G systems can provide access over much larger coverage areas.

Metro systems today are still quite immature and face the following challenges:

- ❑ Many city projects have been discontinued due to the difficulty of providing a viable business model.
- ❑ Today's mesh systems are all proprietary. The IEEE is developing a mesh networking standard—IEEE 802.16s—but this may not be ready until 2008. Even then, it is not clear that vendors will adopt this standard for outdoor systems.
- ❑ Coverage in most metro systems is designed to provide an outdoor signal. As such, the signal does not penetrate many buildings in the coverage area and repeaters are needed to propagate the signal indoors. Many early network deployments have experienced poorer coverage than initially expected, and the number of recommended access points per square mile has increased steadily.
- ❑ Operation is in unlicensed bands in the 2.4 GHz radio channel. Given only three relatively non-overlapping radio channels at 2.4 GHz, interference between public and private systems is inevitable.
- ❑ Though mesh architecture simplifies backhaul, there are still considerable expenses and networking considerations in backhauling a large number of outdoor access points.

Nevertheless, metro networks have attracted considerable interest, and some number of projects are still proceeding. Technical issues will likely be resolved over time, and as more devices support both 3G and Wi-Fi, users can look forward to multiple access options.

Comparison of Wireless Technologies

This section of the paper compares the different wireless technologies, looking at throughput, latency, spectral efficiency, and market position. Finally, the paper presents a table that summarizes the competitive position of the different technologies across multiple dimensions.

Data Throughput

Data throughput is an important metric for quantifying network throughput performance. Unfortunately, the ways in which various organizations quote throughput statistics vary tremendously, which often results in misleading claims. The intent of this paper is to realistically represent the capabilities of these technologies.

One method of representing a technology's throughput is what people call "peak throughput" or "peak network speed." This refers to the fastest possible transmission speed over the radio link, and it is generally based on the highest order modulation available and the least amount of coding (error correction) overhead. Peak network speed is also usually quoted at layer 2 of the radio link. Because of protocol overhead, actual application throughput may be 10 to 20 percent lower (or more) than this layer-2 value. Even if the radio network can deliver this speed, other aspects of the network—such as the backhaul from base station to operator-infrastructure network—can often constrain throughput rates to levels below the radio-link rate.

Another method is to disclose throughputs actually measured in deployed networks with applications such as File Transfer Protocol (FTP) under favorable conditions, which assume light network loading (as low as one active data user in the cell sector) and favorable signal propagation. This number is useful because it demonstrates the high-end, actual capability of the technology. This paper refers to this rate as the "peak user rate." Average rates, however, are lower than this peak rate and difficult to predict because they depend on a multitude of operational and network factors. Except when the network is congested, however, the majority of users should experience throughput rates higher than one-half of the peak-achievable rate.

Some operators, primarily in the US, also quote typical throughput rates. These rates are based on throughput tests the operators have done across their operating networks, and incorporate a higher level of network loading. Though the operators do not disclose the precise methodology they use to establish these figures, the values provide a good indication of what users can typically expect.

Table 4 presents the technologies in terms of peak network throughput rates, peak user-rates (under favorable conditions) and typical rates. It omits values that are not yet known, such as those associated with future technologies.

Table 5: Throughput Performance of Different Wireless Technologies
(Blue Indicates Theoretical Peak Rates, Green Typical)

	Downlink		Uplink	
	Peak Network Speed	Peak And/Or Typical User Rate	Peak Network Speed	Peak And/Or Typical User Rate
EDGE (type 2 MS)	473.6 kbps		473.6 kbps	
EDGE (type 1 MS) (Practical Terminal)	236.8 kbps	200 kbps peak 70 to 135 kbps typical	236.8 kbps	200 kbps peak 70 to 135 kbps typical
Evolved EDGE (type 1 MS)⁴⁹	1184 kbps ⁵⁰		473.6 kbps ⁵¹	

⁴⁹ A type 1 evolved EDGE MS can receive on up to eight timeslots using two radio channels and can transmit on up to four timeslots in one radio channel using 16 QAM modulation with turbo coding.

⁵⁰ Type 1 mobile, class 12 hardware, 10 slots downlink (dual carrier), MTCS-8-B (118.4 kbps/slot)

⁵¹ 4 slots uplink, MCS-8-B

	Downlink		Uplink	
	Peak Network Speed	Peak And/Or Typical User Rate	Peak Network Speed	Peak And/Or Typical User Rate
Evolved EDGE (type 2 MS) ⁵²	1894.4 ⁵³ kbps		947.2 kbps ⁵⁴	
UMTS WCDMA Rel'99	2.048 Mbps		768 kbps	
UMTS WCDMA Rel'99 (Practical Terminal)	384 kbps	350 kbps peak 200 to 300 kbps typical	384 kbps	350 kbps peak 200 to 300 kbps typical
HSDPA Initial Devices (2006)	1.8 Mbps	> 1 Mbps peak	384 kbps	350 kbps peak
HSDPA	14.4 Mbps		384 kbps	
HSPA ⁵⁵ Initial Implementation	7.2 Mbps	> 5 Mbps peak 700 kbps to 1.7 Mbps typical ⁵⁶	2 Mbps	> 1.5 Mbps peak 500 kbps to 1.2 Mbps typical
HSPA Current Implementation	7.2 Mbps		5.76 Mbps	
HSPA	14.4 Mbps		5.76 Mbps	
HSPA+ (DL 64 QAM, UL 16 QAM)	21.6 Mbps		11.5 Mbps	
HSPA+ (2X2 MIMO, DL 16 QAM, UL 16 QAM)	28 Mbps	> 5Mbps typical expected	11.5 Mbps	> 3 Mbps typical expected
HSPA+ (2X2 MIMO, DL 64 QAM, UL 16 QAM)	42 Mbps		11.5 Mbps	
LTE (2X2 MIMO)	173 Mbps	> 10 Mbps typical expected	58 Mbps	> 5 Mbps typical expected

⁵² A type 2-evolved EDGE MS can receive on up to 16 times slots using two radio channels and can transmit on up to eight timeslots in one radio channel using 16 QAM modulation with turbo coding.

⁵³ Type 2 mobile, 16 slots downlink (dual carrier) at MTCS-8-B

⁵⁴ Type 2 mobile, 8 slots uplink, MCS-8-B

⁵⁵ High Speed Packet Access (HSPA) consists of systems supporting both High Speed Downlink Packet Access (HSDPA) and High Speed Uplink Packet Access (HSUPA).

⁵⁶ Typical downlink and uplink throughput rates based on AT&T press release, June 4, 2008

	Downlink		Uplink	
	Peak Network Speed	Peak And/Or Typical User Rate	Peak Network Speed	Peak And/Or Typical User Rate
LTE (4X4 MIMO)	326 Mbps		86 Mbps	
CDMA2000 1XRTT	153 kbps	130 kbps peak	153 kbps	130 kbps peak
CDMA2000 1XRTT	307 kbps		307 kbps	
CDMA2000 EV-DO Rev 0	2.4 Mbps	> 1 Mbps peak	153 kbps	150 kbps peak
CDMA2000 EV-DO Rev A	3.1 Mbps	> 1.5 Mbps peak 600 kbps to 1.4 Mbps typical ⁵⁷	1.8 Mbps	> 1 Mbps peak 300 to 500 kbps typical
CDMA2000 EV-DO Rev B (3 radio channels MHz)	9.3 Mbps		5.4 Mbps	
CDMA2000 EV-DO Rev B Theoretical (15 radio channels)	73.5 Mbps		27 Mbps	
Ultra Mobile Broadband (2X2 MIMO)	140 Mbps		34 Mbps	
Ultra Mobile Broadband (4X4 MIMO)	280 Mbps		68 Mbps	
802.16e WiMAX expected Wave 1 (10 MHz TDD DL/UL=3, 1X2 SIMO)	23 Mbps		4 Mbps	
802.16e WiMAX expected Wave 2 (10 MHz TDD, DL/UL=3, 2x2 MIMO)	46 Mbps		4 Mbps	
802.16m	TBD		TBD	

Rysavy Research's 2002 paper for 3G Americas on wireless data anticipated EDGE average performance of 110 to 130 kbps and UMTS average performance of 200 to 300 kbps. Actual results from operator and vendor field trials matched these predicted results validating the methodology used to predict performance. In the 2004 and 2005 versions of this paper, the 550 to 800 kbps throughput performance of initial HSDPA devices has been borne out as fairly accurate.

⁵⁷ Typical downlink and uplink throughput rates based on Sprint press release January 30, 2007.

HSDPA Throughput in Representative Scenarios

It is instructive to look at actual HSDPA throughput in commercial networks. Figure 11 shows the throughputs measured in one network with voice and data in one Western European country across three larger cities. The data shows the percentage of samples on the X axis that fall below the throughput shown on the Y axis. For example, the 75 percentile is at 5 Mbps, meaning that 75% of samples are below 5 Mbps and 25% are above. Significantly, half of all the measurements showed 4 Mbps or higher throughput.

Figure 11: HSDPA Throughput Distribution in Deployed Networks⁵⁸

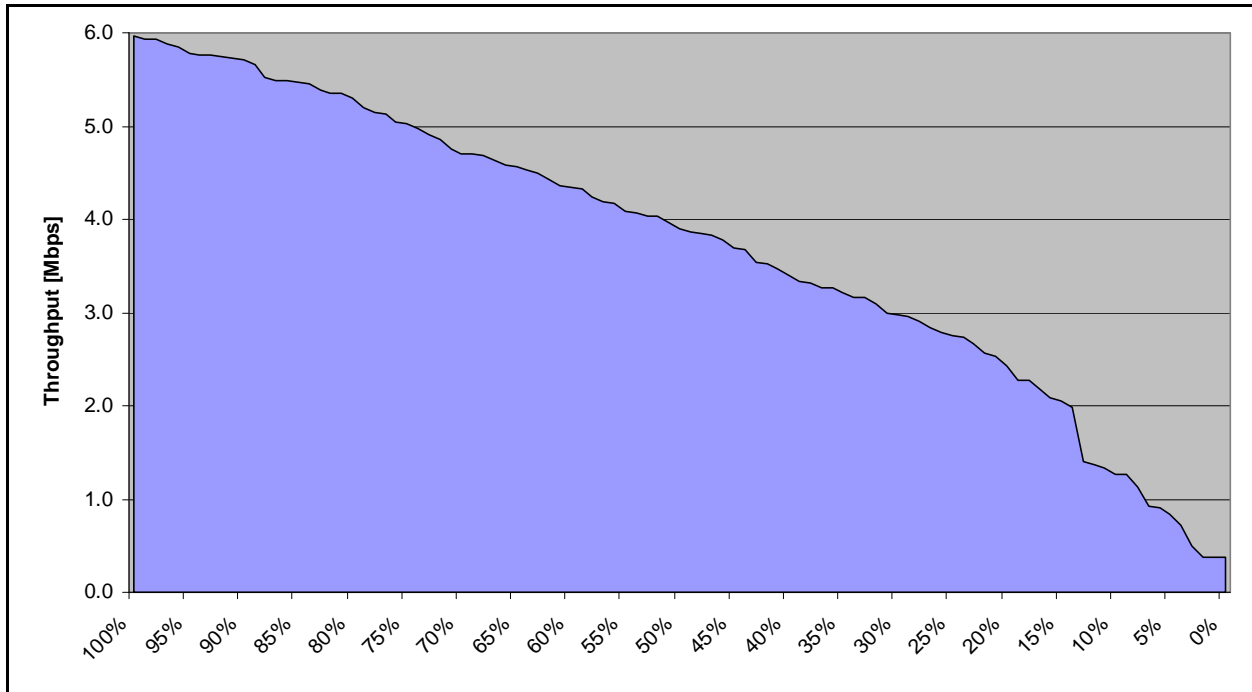

In another network study, Figure 12 shows the downlink throughput performance of a 7.2 Mbps device. (peak data rate capability). It results in a median throughput of 1.9 Mbps when mobile, 1.8 Mbps with poor coverage, and 3.8 Mbps with good coverage.

⁵⁸ Source: 3G Americas member company contribution.

Figure 12: HSDPA Performance of a 7.2 Mbps Device in a Commercial Network⁵⁹

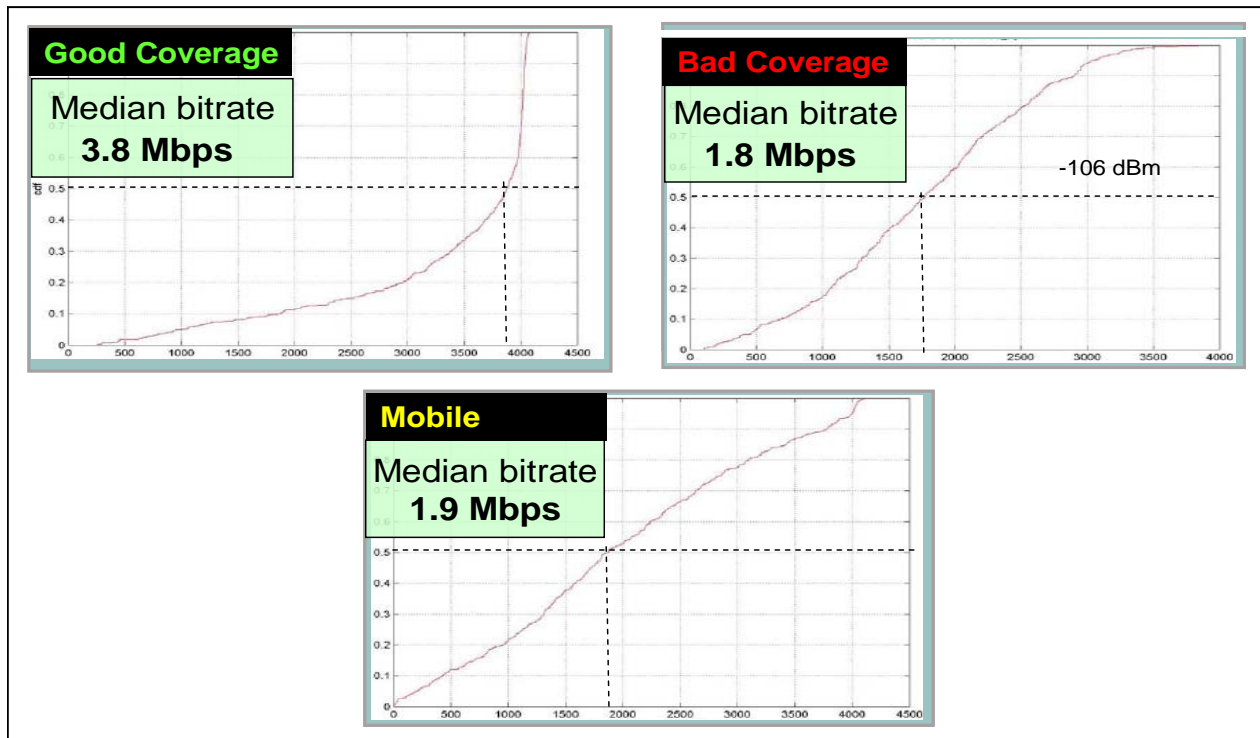

These rates are consistent with other vendor information for two deployed HSPA networks that supported 7.2 Mbps HSDPA. Testers measured average FTP downlink application throughput of 2.1 Mbps in the first network, and 1.9 Mbps in the second network.⁶⁰

Release 99 and HSUPA Uplink Performance

HSUPA dramatically increases uplink throughputs over 3GPP Release 99. However, even Release 99 networks have seen significant uplink increases. Many networks were initially deployed with a 64 kbps uplink rate. Later, this increased to 128 kbps. Later, operators increased speeds to 384 kbps peak rates, with peak user-achievable rates of 350 kbps.

The anticipated 1 Mbps achievable uplink throughput with HSUPA can be seen in the measured throughput of a commercial network, as documented in Figure 13. The X axis shows throughput rate, the Y axis shows the cumulative distribution function and the bars show the number of samples obtained for that throughput rate on a relative basis. The median bit rate is 1.0 Mbps.

⁵⁹ Source: 3G Americas member company contribution.

⁶⁰ Source: 3G Americas member company contribution.

Figure 13: Uplink Throughput in a Commercial Network⁶¹

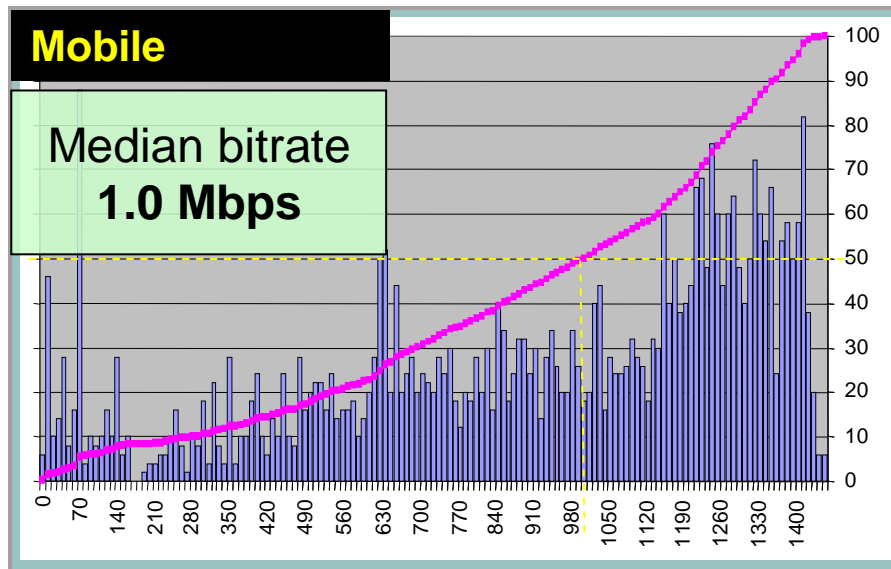

These rates are consistent with other vendor information for a deployed HSPA network that supported 2.0 Mbps HSUPA⁶² uplink speed. Testers measured average FTP downlink application throughput of 1.2 Mbps⁶³.

LTE Throughput

As part of the LTE/SAE/EPC Trial Initiative (LSTI), vendors are testing LTE technology. Figure 14 shows LTE throughputs in a 2X2 MIMO trial network reaching a maximum of 154 Mbps, a mean of 78 Mbps and a minimum of 16 Mbps. Until operators actually deploy complete networks, typical rates will not be available, but the data suggests that users should be able to obtain throughputs an order of magnitude higher than today's 3G networks.

⁶¹ Source: 3G Americas member company contribution.

⁶² 2 x spreading factor (2xSF2) code configuration.

⁶³ Source: 3G Americas member company contribution.

Figure 14: LTE Measured Throughput in Test Network⁶⁴

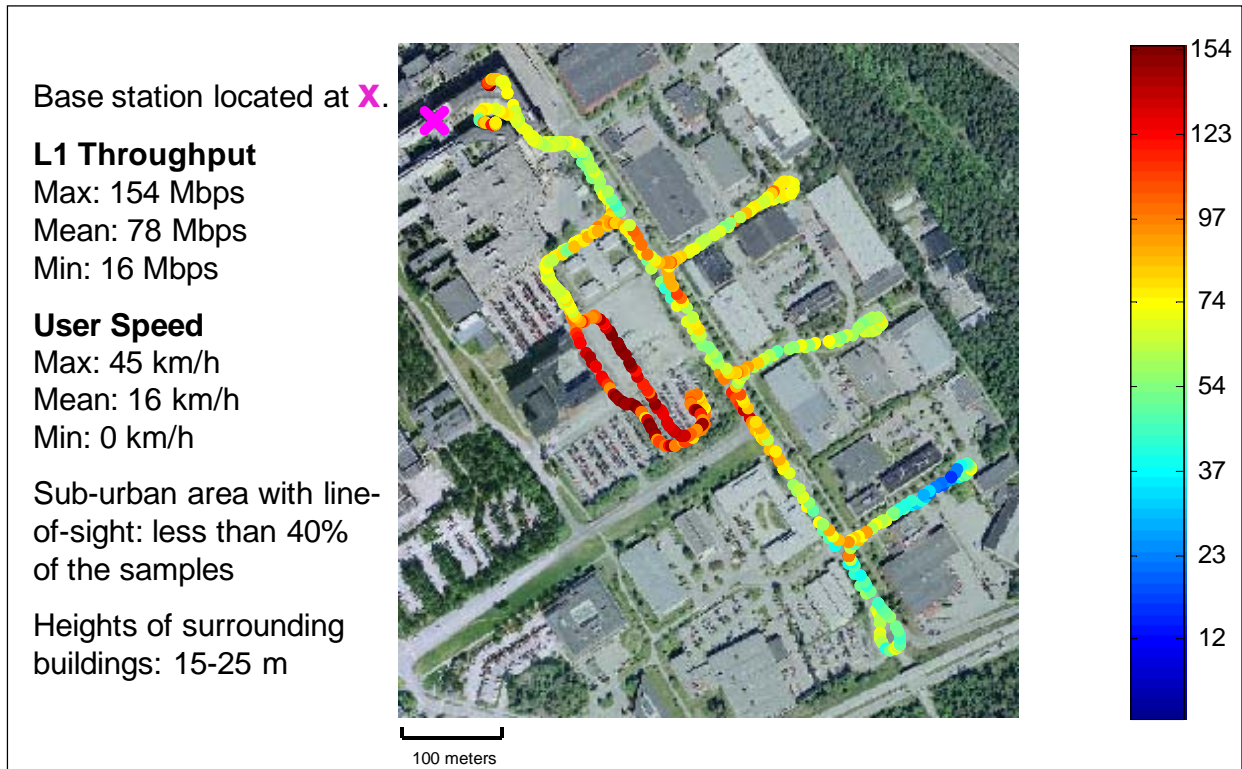

Latency

Just as important as throughput is network latency, defined as the round-trip time it takes data to traverse the network. Each successive data technology from GPRS forward reduces latency, with HSDPA networks having latency as low as 70 milliseconds (msec). HSUPA brings latency down even further, as will 3GPP LTE. Ongoing improvements in each technology mean all these values will go down as vendors and operators fine tune their systems. Figure 15 shows the latency of different 3GPP technologies.

⁶⁴ Source: 3G Americas member company contribution.

Figure 15: Latency of Different Technologies⁶⁵

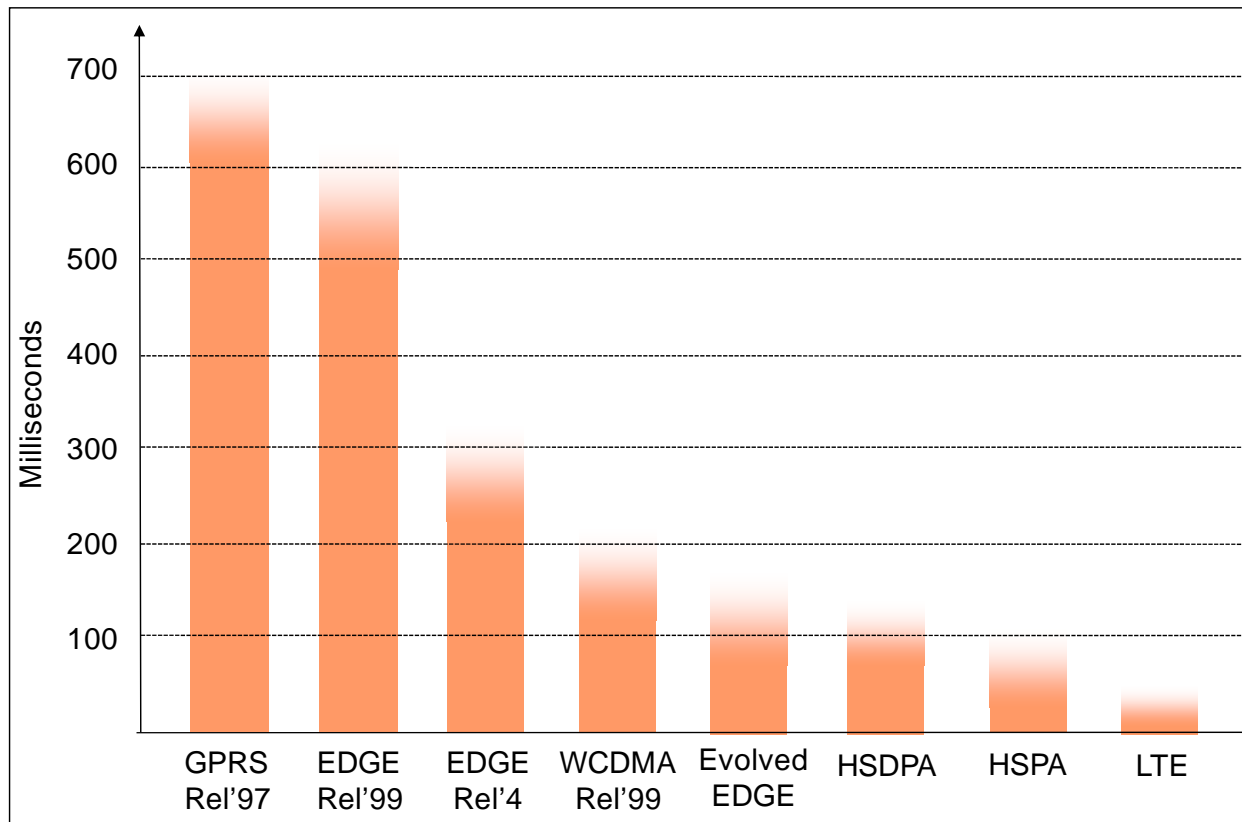

The values shown in Figure 15 reflect measurements of commercially deployed technologies. Some vendors have reported significantly lower values in networks using their equipment, such as 150 msec for EDGE, 70 msec for HSDPA, and 50 msec for HSPA. With further refinements and the use of 2 msec Transmission Time Interval (TTI) in the HSPA uplink, 25 msec roundtrip is a realistic goal. LTE will reduce latency even further, to as low as 10 msec in the radio-access network.

Spectral Efficiency

To better understand the reasons for deploying the different data technologies and to better predict the evolution of capability, it is useful to examine spectral efficiency. The evolution of data services will be characterized by an increasing number of users with ever-higher bandwidth demands. As the wireless-data market grows, deploying wireless technologies with high spectral efficiency will be of paramount importance. Keeping all other things equal, such as frequency band, amount of spectrum, and cell site spacing, an increase in spectral efficiency translates to a proportional increase in the number of users supported at the same load per user—or, for the same number of users, an increase in throughput available to each user. Delivering broadband services to large numbers of users can best be achieved with high spectral efficiency systems, especially

⁶⁵ Source: 3G Americas' member companies. Measured between subscriber unit and Gi interface, immediately external to wireless network. Does not include Internet latency. Note that there is some variation in latency based on network configuration and operating conditions.

because the only other alternatives are using more spectrum or deploying more cell sites.

Increased spectral efficiency, however, comes at a price. It generally implies greater complexity for both user and base station equipment. Complexity can arise from the increased number of calculations performed to process signals or from additional radio components. Hence, operators and vendors must balance market needs against network and equipment costs. One core aspect of evolving wireless technology is managing the complexity associated with achieving higher spectral efficiency. The reason technologies such as OFDMA are attractive is that they allow higher spectral efficiency with lower overall complexity; thus their use in technologies such as LTE, UMB, and WiMAX.

The roadmap for the EDGE/HSPA/LTE family of technologies provides a wide portfolio of options to increase spectral efficiency. The exact timing for deploying these options is difficult to predict, because much will depend on the growth of the wireless data market, and what types of applications become popular.

When determining the best area on which to focus future technology enhancements, it is interesting to note that HSDPA, 1xEV-DO, and IEEE 802.16e-2005 all have highly optimized links—that is, physical layers. In fact, as shown in Figure 16, the link layer performance of these technologies is approaching the theoretical limits as defined by the Shannon bound. (The Shannon bound is a theoretical limit to the information transfer rate [per unit bandwidth] that can be supported by any communications link. The bound is a function of the Signal to Noise Ratio [SNR] of the communications link.) Figure 16 also shows that HSDPA, 1xEV-DO, and IEEE 802.16e-2005 are all within 2 to 3 decibels (dB) of the Shannon bound, indicating that there is not much room for improvement from a link layer perspective. Note that differences do exist in the design of the MAC layer (layer 2) and this may result in lower than expected performance in some cases as described previously.

Figure 16: Performance Relative to Theoretical Limits for HSDPA, EV-DO, and IEEE 802.16e-2005⁶⁶

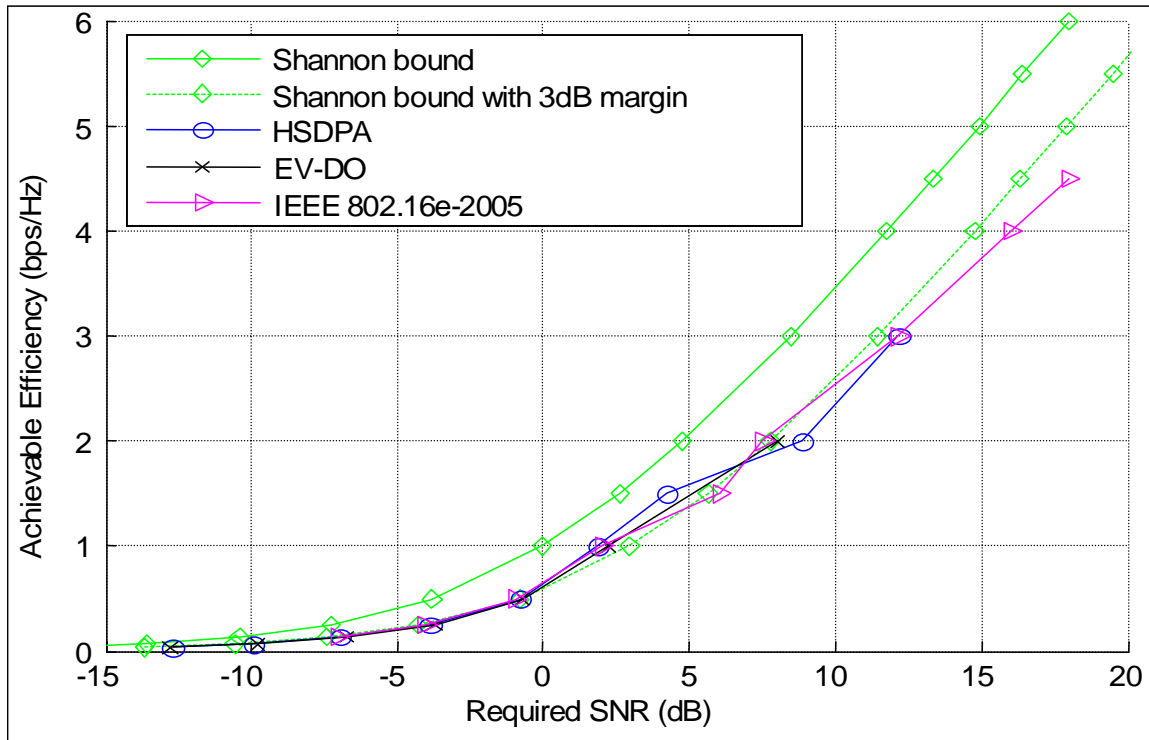

The curves in Figure 16 apply to an Additive White Gaussian Noise Channel (AWGN). If the channel is slowly varying and the effect of frequency selectivity can be overcome through an equalizer in either HSDPA or OFDM, then the channel can be known almost perfectly and the effects of fading and non-AWGN interference can be ignored—thus justifying the AWGN assumption. For instance, at 3 km per hour, and fading at 2 GHz, the Doppler spread is about 5.5 Hz. The coherence time of the channel is thus 1 sec/5.5 or 180 msec. Frames are well within the coherence time of the channel, because they are typically 20 msec or less. As such, the channel appears “constant” over a frame and the Shannon bound applies. Much more of the traffic in a cellular system is at slow speeds (for example, 3 km/hr) rather than at higher speeds. Thus, the Shannon bound is relevant for a realistic deployment environment.

As the speed of the mobile station increases and the channel estimation becomes less accurate, additional margin is needed. However, this additional margin would impact the different standards fairly equally.

The Shannon bound only applies to a single user; it does not attempt to indicate aggregate channel throughput with multiple users. However, it does indicate that link layer performance is reaching theoretical limits. As such, the focus of future technology enhancements should be on improving system performance aspects that maximize the experienced SNRs in the system rather than on investigating new air interfaces that attempt to improve the link layer performance.

⁶⁶ Source: 3G Americas' member company.

Examples of technologies that improve SNR in the system are those that minimize interference through intelligent antennas or interference coordination between sectors and cells. Note that MIMO techniques using spatial multiplexing to potentially increase the overall information transfer rate by a factor proportional to the number of transmit or receive antennas do not violate the Shannon bound, because the per antenna transfer rate (that is, the per communications link transfer rate) is still limited by the Shannon bound.

Figure 17 compares the spectral efficiency of different wireless technologies based on a consensus view of 3G Americas contributors to this paper. It shows the continuing evolution of the capabilities of all the technologies discussed. The values shown are conservative and intended to be reasonably representative of real-world conditions. Most simulation results produce values under idealized conditions; as such, some of the values shown are lower (for all technologies) than the values indicated in other papers and publications. For instance, 3GPP studies indicate higher HSDPA and LTE spectral efficiencies than those shown below.

Figure 17: Comparison of Downlink Spectral Efficiency⁶⁷

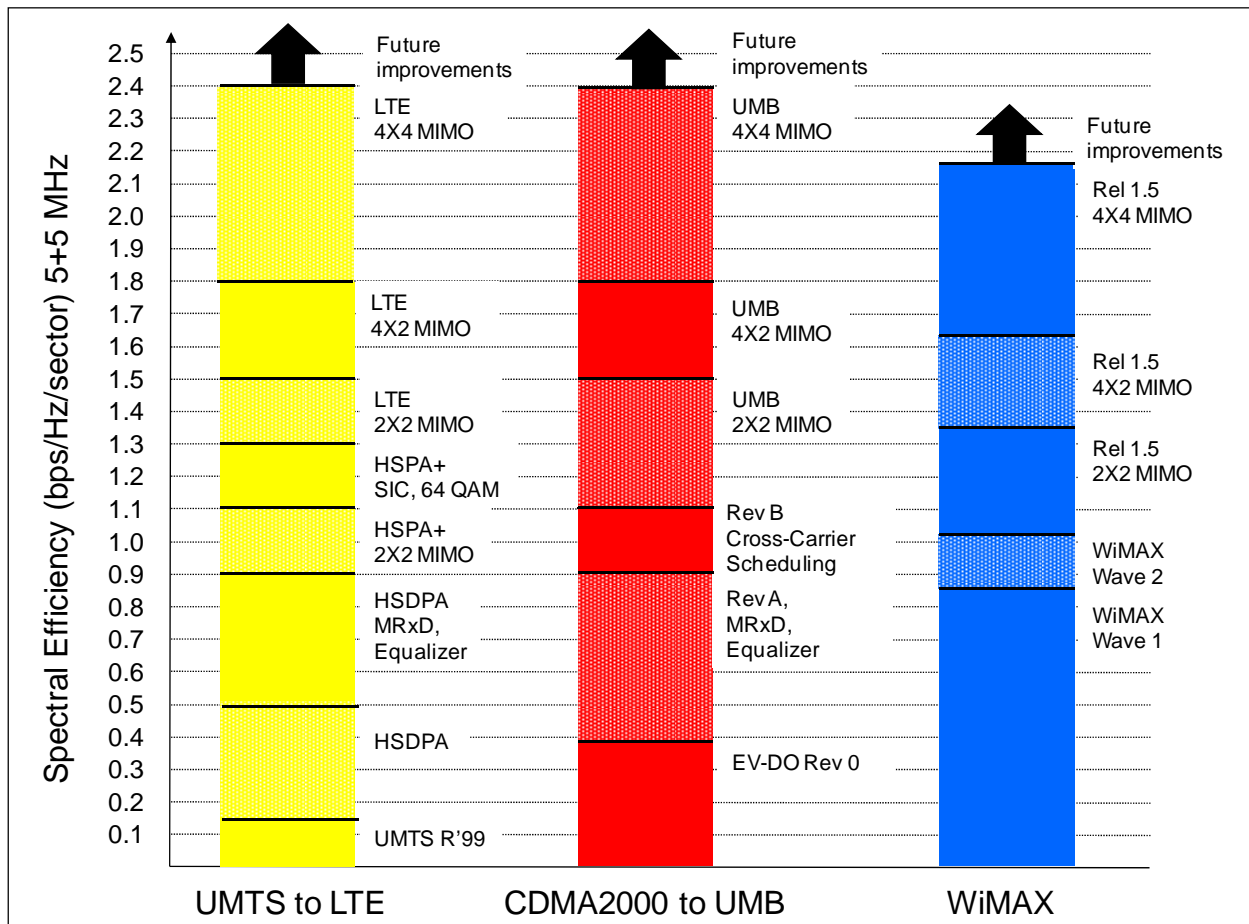

⁶⁷ Source: Joint analysis by 3G Americas' members. 5+5 MHz for UMTS/HSPA/LTE and CDMA2000, and 10 MHz DL/UL=3:1 TDD for WiMAX. WiMAX Wave 2 AMC not included. Mix of mobile and stationary users. WiMAX Release 1.5 data preliminary, based on expected features.

The values shown in Figure 17 are not all the combinations of available features. Rather, they are representative milestones in ongoing improvements in spectral efficiency. For instance, there are terminals that employ mobile-receive diversity but not equalization.

The figure does not include EDGE, but EDGE itself is spectrally efficient, at 0.3 bps/Hz/sector. Relative to WCDMA Release 99, HSDPA increases capacity by almost a factor of three. Type 3 receivers that include Minimum Mean Square Error (MMSE) equalization and Mobile Receive Diversity (MRxD) will effectively double HSDPA spectral efficiency. HSPA+ in Release 7 includes 2X2 MIMO, which further increases spectral efficiency by about 20 percent and matches WiMAX Wave 2 spectral efficiency. Methods like successive interference cancellation (SIC) and 64 QAM allow gains in spectral efficiency as high as 1.3 bps/Hz/sector, which is close to LTE performance in 5+5 MHz channel bandwidth. Terminals with SIC can also be used with Release 7 systems.

With respect to actual deployment, some enhancements, such as 64 QAM, will be simpler for some operators to deploy than other enhancements, such as 2X2 MIMO. The former can be done as a software upgrade, whereas the latter requires additional hardware at the base station. Thus the figure does not necessarily show the actual progression of technologies that operators will deploy to increase spectral efficiency.

Beyond HSPA, 3GPP LTE will also result in further spectral efficiency gains, initially with 2X2 MIMO, and then optionally with SIC, 4X2 MIMO and 4X4 MIMO. LTE is even more spectrally efficient with wider channels, such as 10 and 20 MHz.

Similar gains are available for CDMA2000. Mobile WiMAX also experiences gains in spectral efficiency as various optimizations, like MRxD and MIMO, are applied. WiMAX Wave 2 includes 2X2 MIMO. Enhancements to WiMAX will come from a new profile defined in Release 1.5, as well as other future enhancements.

The main reason that HSPA+ with MIMO is shown as more spectrally efficient than WiMAX Wave 2 with MIMO is because HSPA MIMO supports closed-loop operation with precoding and multicodeword MIMO, which enables the use of SIC receivers. Other reasons are that HSPA supports incremental-redundancy HARQ, while the initial WiMAX profiles support only Chase Combining HARQ, and that WiMAX has larger control overhead in the downlink than HSPA, because the uplink in WiMAX is fully scheduled. OFDMA technology requires scheduling to avoid two mobile devices transmitting on the same tones simultaneously. An uplink MAP zone in the downlink channel does this scheduling.

LTE has higher spectral efficiency than WiMAX Wave 2 for a number of reasons:⁶⁸

- Closed-loop operation with precoded weighting.
- Multi codeword MIMO which enable the use of SIC receivers.
- Lower Channel Quality Indicator delay through use of 1 msec frames instead of 5 msec frames.
- Greater control channel efficiency.
- Incremental redundancy in error correction.
- Finer granularity of modulation and coding schemes.

⁶⁸ IEEE International Symposium on Personal, Indoor and Mobile Radio Communications: Anders Furuskär et al "The LTE Radio Interface – Key Characteristics and Performance", 2008.

WiMAX Release 1.5 will address some of these items, and will thus have increased spectral efficiency. Expected features include reduced MAC overhead, adaptive modulation and coding, and other physical-layer enhancements. At the time of this paper, the feature set is neither public nor final, and hence the spectral efficiency values shown are preliminary and subject to change. Vendor estimates for Release 1.5 range from about 77% to 98% of LTE spectral efficiency for downlink data.⁶⁹ Thus if the final spectral efficiency analysis for WiMAX Release 1.5 comes at the low end of the range, it would fall well below LTE performance and could also fall below HSPA+ spectral efficiency. Since there is a wide range in projected spectral efficiency, the assessment of actual performance of WiMAX Release 1.5 relative to HSPA+ and LTE must await further analysis.

One available improvement for LTE spectral efficiency not shown in the figure is successive interference cancellation. This will result in a gain of 5% in a low mobility environment and a gain of 10 to 15% in environments such as picocells in which there is cell isolation.

An important conclusion of this comparison is that all the major wireless technologies achieve comparable spectral efficiency through the use of comparable radio techniques.

Figure 18 compares the uplink spectral efficiency of the different systems.

⁶⁹ Contributions to 3G Americas by 3G Americas member companies.

Figure 18: Comparison of Uplink Spectral Efficiency⁷⁰

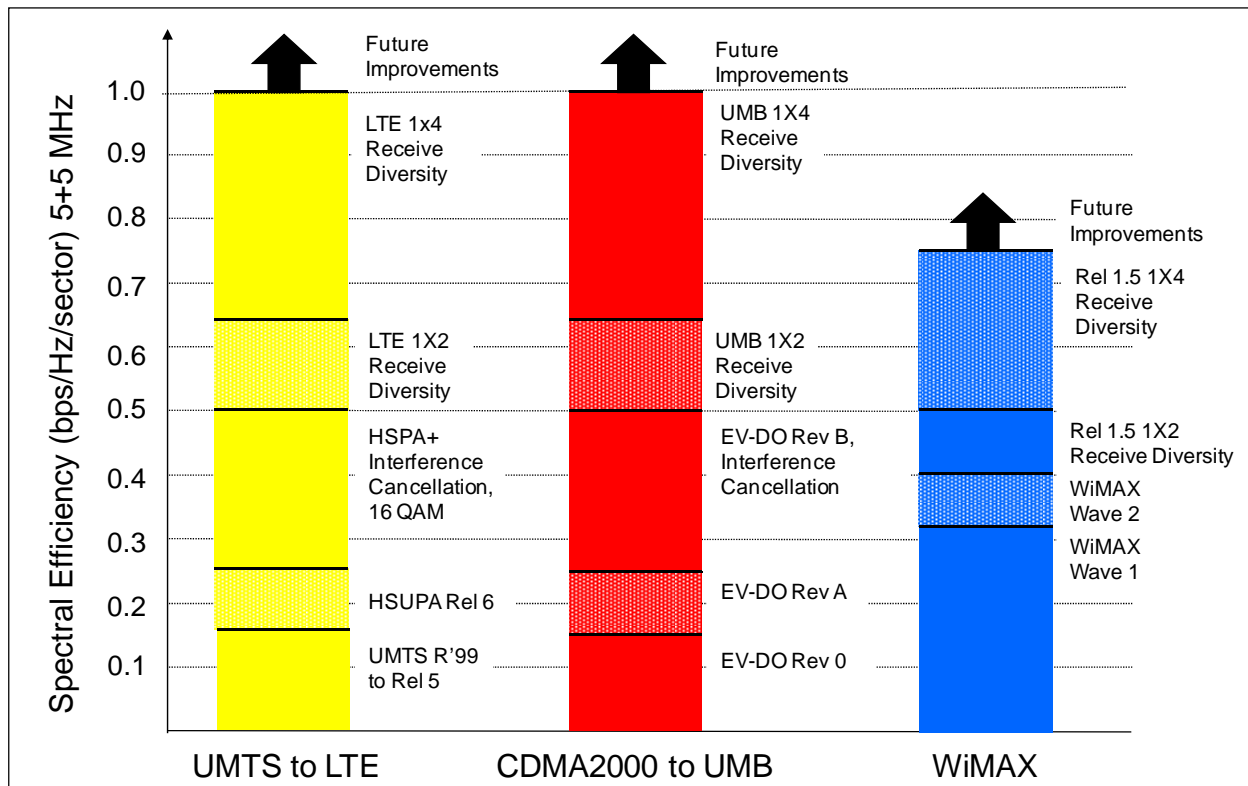

The implementation of HSUPA in HSPA significantly increases uplink capacity, as does Rev A of 1xEV-DO, compared to Rev 0. OFDM-based systems can exhibit improved uplink capacity relative to CDMA technologies, but this improvement depends on factors such as the scheduling efficiency and the exact deployment scenario. With LTE, spectral efficiency gains increase by use of receive diversity. Initial systems will employ 1X2 receive diversity (two antennas at the base station), and later 1X4 diversity, which should increase spectral efficiency by 50%. It is also possible to employ Multi-User MIMO (MU-MIMO) which allows simultaneous transmission by multiple users on the uplink on the same physical resource to increase spectral efficiency and is, in fact, easier to implement than true MIMO because it does not require an additional transmitter in the mobile device. Spectral efficiency gains, however, with MU-MIMO are not as great as with the receive diversity schemes.

Figure 18 shows WiMAX Wave 2 uplink spectral efficiency to be lower than 3GPP and 3GPP2 technologies employing interference cancellation. This is because of the high pilot overhead in IEEE 802.16e, which accounts for up to 33 percent of tones. With the optional, but more efficient pilot structure implemented, it is likely that IEEE 802.16e uplink spectral efficiency will be on par.

⁷⁰ Source: Joint analysis by 3G Americas' members. 5+5 MHz for UMTS/HSPA/LTE and CDMA2000, and 10 MHz DL/UL=3:1 TDD for WiMAX. Mix of mobile and stationary users. WiMAX Release 1.5 data preliminary, based on expected features.

Vendor estimates for Release 1.5 range from about 57% to 98% of LTE spectral efficiency for uplink data and the values shown are preliminary and subject to change.⁷¹

Figure 19 compares voice spectral efficiency. It assumes a round-robin type of scheduler, as opposed to a proportional-fair scheduler that is normally used for asynchronous data.

Figure 19: Comparison of Voice Spectral Efficiency⁷²

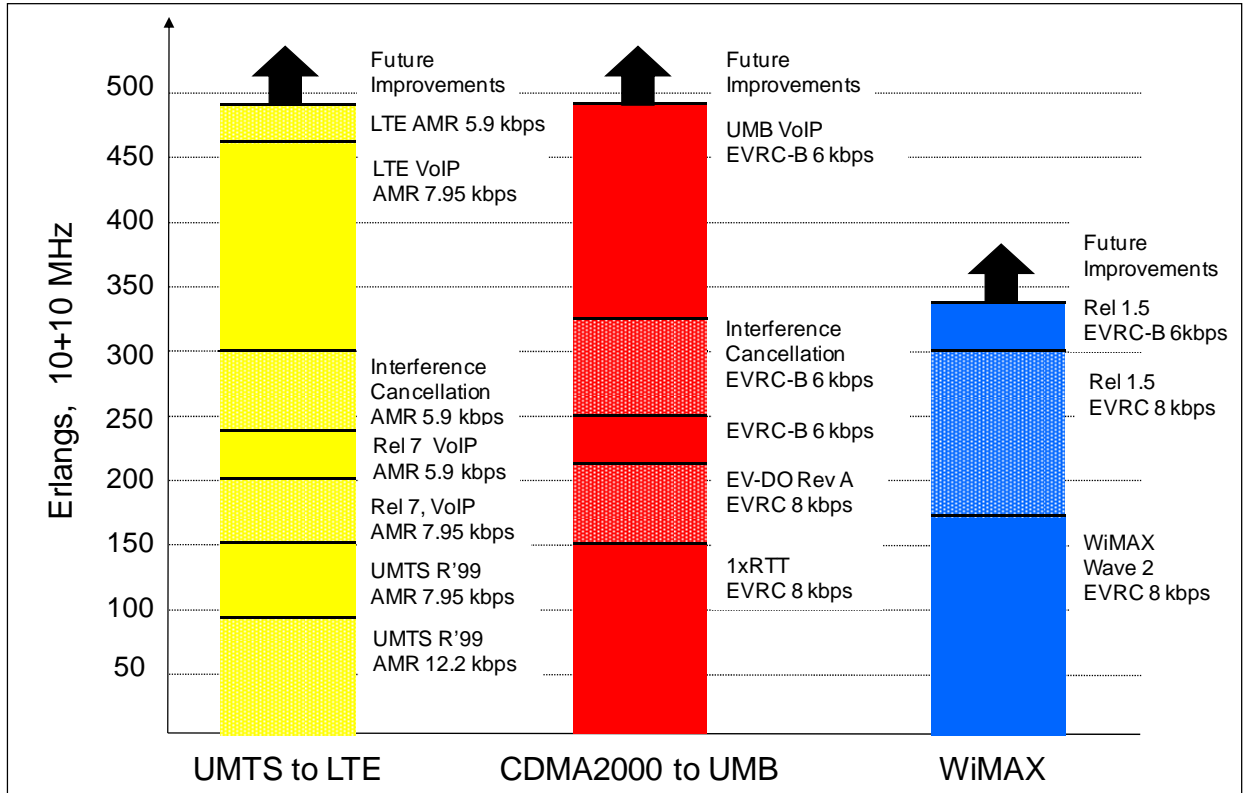

Figure 19 shows UMTS R'99 with both AMR 12.2 kbps and 7.95 kbps vocoders. The AMR 12.2 kbps vocoder provides superior voice quality in good (e.g., static, indoors) channel conditions. UMTS has dynamic adaptation between vocoder rates, enabling enhanced voice quality compared to EVRC at the expense of capacity in situations that are not capacity limited.

Opportunities will arise to improve voice capacity using VoIP over HSPA channels. Depending on the specific enhancements implemented, voice capacity could double over existing circuit-switched systems. It should be noted, however, that the gains are not related specifically to the use of VoIP; rather, gains relate to advances in radio techniques applied to the data channels. Many of these same advances may also be applied to current circuit-switched modes. This is what the CS over HSPA work item will

⁷¹ Contributions to 3G Americas by 3G Americas member companies.

⁷² Source: Joint analysis by 3G Americas' members. 10 + 10 MHz for UMTS/HSPA/LTE and CDMA2000, and 20 MHz DL/UL=3:1 TDD for WiMAX. Mix of mobile and stationary users. WiMAX Release 1.5 data preliminary, based on expected features.

achieve. However, other benefits of VoIP are driving the migration to packet voice. Among these benefits are a consolidated IP core network for operators and sophisticated multimedia applications for users.

EV-DO technologies could possibly exhibit a slightly higher spectral efficiency for VoIP than HSPA technologies (though not for packet data in general), as they operate purely in the packet domain and do not have circuit-switched control overhead.⁷³ Until VoIP over EV-DO becomes available, HSPA will have the significant advantage, however, of being able to support simultaneous circuit-switched and packet-switched users on the same radio channel.

With respect to codecs, in VoIP systems such as LTE, UMB and WiMAX, a variety of codecs can be used. The figures show performance assuming specific codecs at representative bit rates. For codecs such as EVRC (Enhanced Variable Rate Codec), the bit rate shown is an average value.

Though WiMAX Release 1.5 has high downlink and uplink spectral efficiency for VoIP, it has a disadvantage relative to LTE because it only supports 5 msec frames while LTE supports 1 msec frames. The use of 5 msec frames limits the number of HARQ retransmissions in each 20 msec speech frame. LTE can support multiple HARQ retransmissions within a 20 msec speech frame, whereas WiMAX can only support one.

Cost, Volume and Market Comparison

So far, this paper has compared wireless technologies on the basis of technical capability and demonstrated that many of the different options have similar technical attributes. This is for the simple reason that they employ many of the same approaches.

There is a point of comparison, however, in which the differences between the technologies diverge tremendously; namely, the difference in volume involved including subscribers and the amount of infrastructure required. This difference should translate to dramatically reduced costs for the highest volume solutions, specifically GSM/UMTS. Based on projections and numbers already presented in this paper, 3G subscribers on UMTS networks will number in the many hundreds of millions by the end of this decade, whereas subscribers to emerging wireless technologies such as IEEE 802.16e-2005 will number in the tens of millions. See Figure 20 for details.

⁷³ Transmit Power Control (TPC) bits on the uplink Dedicated Physical Control Channel DPCCH in UMTS R'99. See also IEEE Journal on Selected Areas in Communication, Vol 24, No.1, Qi Bi, "An Analysis of VoIP Service Using 1 EV-DO Revision A System", January, 2006.

Figure 20: Relative Volume of Subscribers Across Wireless Technologies⁷⁴

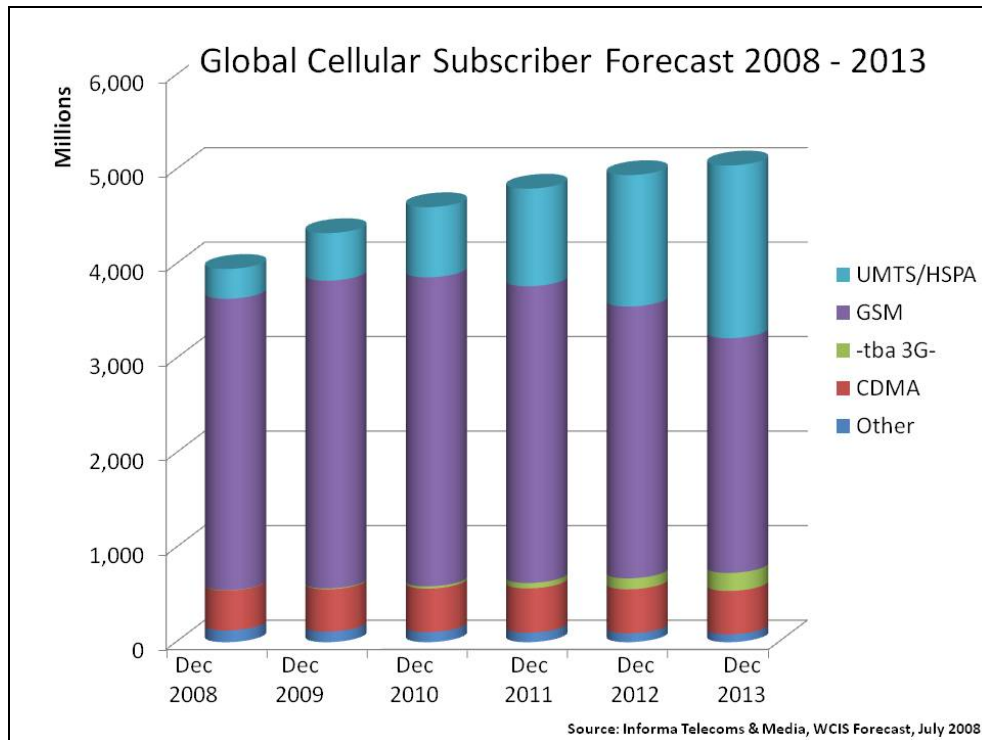

Although proponents for technologies such as mobile WiMAX point to lower costs for their alternatives, there doesn't seem to be any inherent cost advantage—even on an equal volume basis. And when factoring in the lower volumes, any real-world cost advantage is debatable.

From a deployment point of view, the type of technology used (for example, HSPA versus WiMAX) only applies to the software supported by the digital cards at the base station. This cost, however, is only a small fraction of the base station cost with the balance covering antennas, power amplifiers, cables, racks, RF cards,. As for the rest of the network including construction, backhaul, and core-network components, costs are similar regardless of Radio Access Network (RAN) technology. Spectrum costs for each technology can differ greatly depending on a country's regulations and the spectrum band. As a general rule in most parts of the world, spectrum sold at 3.5 GHz will cost much less than spectrum sold at 850 MHz (all other things being equal).

As for UMTS/HSPA versus CDMA2000, higher deployment—by a factor of five—could translate to significant cost savings. For example, research and development amortization results in a four-to-one difference in base station costs.⁷⁵ Similarly, just as GSM handsets are considered much less expensive than 1xRTT handsets, UMTS wholesale terminal prices could be the market leader in low-cost or mass-market 3G terminals. Developments such as single-chip UMTS complementary metal oxide

⁷⁴ Source: Informa Telecoms & Media, WCIS Forecast, July 2008

⁷⁵ Source: 3G Americas member analysis.

semiconductor (CMOS) transceivers could be particularly effective in making UMTS/HSDPA devices more affordable to the mass market.⁷⁶

Even LTE is on the road to a robust wireless ecosystem and significant economies of scale. In June of 2008, the Next Generation Mobile Networks (NGMN) alliance confirmed its selection of LTE. Dr. Peter Meissner, Operating Officer of NGMN announced that, “based on intensive and detailed technology evaluations, 3GPP LTE/SAE is the first technology which broadly meets its recommendations and is approved by its Board.”⁷⁷ The NGMN is comprised of 18 mobile network operators, 29 vendor sponsors and 3 University research institutes. Its operator members include: Alltel, AT&T, China Mobile, France Telecom, Royal KPN, MSV Mobile Satellite Ventures, NTT DoCommo, Reliance Communications, SK Telecom, Telecom Italia, Telefonica, Telenor, TeliaSonera, Telstra, Telus, T-Mobile and Vodafone.

In reference to the NGMN Alliance announcement, Michael Thelander, CEO and Founder of Signals Research Group, a US-based wireless research consultancy, stated that, “the implications could be significant, and if nothing else, eighteen of the world’s largest mobile operators have spoken...”⁷⁸

Competitive Summary

Based on the information presented in this paper, Table 6 summarizes the competitive position of the different technologies discussed.

Table 6: Competitive Position of Major Wireless Technologies

Technology	EDGE/HSPA/LTE	CDMA2000/UMB	IEEE 802.16e WiMAX
Subscribers	Over 3 billion today; 4 billion expected by 2010	438 million ⁷⁹ today; slower growth expected than GSM/UMTS	Less than 54 million by 2012
Maturity	Extremely mature	Extremely mature	Emerging/immature
Adoption	Cellular operators globally	Cellular operators globally for CDMA 2000. No commitments to UMB.	Limited to date
Coverage/Footprint	Global	Global with the general exception of Western Europe	Very limited
Deployment	Fewer cell sites required at 700 and 850 MHz.	Fewer cell sites required at 700 and 850 MHz.	Many more cell sites required at 2.5 GHz.

⁷⁶ Source: Qualcomm press release Feb 13, 2007.

⁷⁷ <http://www.umts-forum.org/content/view/2479/172/>

⁷⁸ http://www.3gamerica.org/English/news_room/DisplayPressRelease.cfm?id=3359&s=ENG

⁷⁹ Source: CDG, July 2008.

Technology	EDGE/HSPA/LTE	CDMA2000/UMB	IEEE 802.16e WiMAX
Devices	Broad selection of GSM/EDGE/UMTS/HSPA devices	Broad selection of 1xRTT/EV-DO devices	None yet; initial devices likely to emphasize data
Radio Technology	Highly optimized TDMA for EDGE, highly optimized CDMA for HSPA, highly optimized OFDMA for LTE	Highly optimized CDMA for Rev 0/A/B, highly optimized OFDMA for Rev C	OFDMA in Wave 1, more optimized in Wave 2, highly optimized in Release 1.5
Spectral Efficiency	Very high with HSPA, matches OFDMA approaches in 5 MHz with HSPA+	Very high with EV-DO Rev A/B	Very high, but not higher than HSPA+
Throughput Capabilities	Peak downlink user-achievable rates of over 4 Mbps today, with significantly higher rates in the future	Peak downlink user-achievable rates of over 1.5 Mbps, with significantly higher rates in the future	Peak downlink user-achievable rates will depend on network design
Latency	As low as 70 msec with HSPA today, with much lower latency in the future	As low as 70 msec with EV-DO Rev A, with much lower latency in the future	To be determined
Voice Capability	Extremely efficient circuit-voice available today; smoothest migration to VoIP of any technology	Extremely efficient circuit-voice available today EV-DO radio channels with VoIP cannot support circuit-voice users	Relatively inefficient VoIP initially; more efficient in later stages, but lower than LTE. Voice coverage will be much more limited than cellular
Simultaneous Voice and Data	Available with GSM ⁸⁰ and UMTS today	Not available today Available with VoIP	Potentially available, though initial services will emphasize data
Efficient Spectrum Usage	Entire UMTS radio channel available for any mix of voice and high-speed data	Radio channel today limited to either voice/medium speed data or high-	Efficient for data-centric networks only until later versions

⁸⁰ With the application of Dual Transfer Mode.

Technology	EDGE/HSPA/LTE	CDMA2000/UMB	IEEE 802.16e WiMAX
		speed data only	

Conclusion

Thanks to constant innovation, the EDGE/HSPA/LTE family of technologies has proven itself as the predominant wireless network solution, and offers operators and subscribers a true mobile-broadband advantage. The continued use of GSM and EDGE technology through ongoing enhancements allows operators to leverage existing investments. With UMTS/HSPA, the technologies' advantages provide for broadband services that will deliver increased data revenue and provide a path to all-IP architectures. With LTE, now the most widely chosen technology platform for the forthcoming decade, the advantages offer a best-of-breed, long-term solution that matches or exceeds the performance of competing approaches. In all cases, the different radio-access technologies can coexist using the same core architecture.

Today, HSPA offers the highest peak data rates of any widely available, wide-area wireless technology. With continued evolution, peak data rates will continue to increase, spectral efficiency will increase, and latency will decrease. The result is support for more users at higher speeds with more applications enabled. The scope of applications will also increase as new services become available such as location information and video. Greater efficiencies will translate to more competitive offers, greater network usage, and increased revenues.

Because of practical benefits and deployment momentum, the migration path from EDGE to HSPA then to LTE is inevitable. Benefits include the ability to roam globally, huge economies of scale, widespread acceptance by operators, complementary services such as messaging and multimedia, and an astonishing variety of competitive handsets and other devices. Currently more than 210 commercial UMTS/HSPA networks and 236 UMTS networks are already in operation. UMTS/HSPA offers an excellent migration path for GSM operators, as well as an effective technology solution for greenfield operators.

EDGE has proven to be a remarkably effective and efficient technology for GSM networks. It achieves high spectral efficiency and data performance that today support a wide range of applications. Evolved EDGE will greatly enhance EDGE capabilities—doubling and, potentially, quadrupling throughputs—making the technology viable for many years to come.

Whereas EDGE is efficient for narrowband data services, the UMTS/HSPA radio link is efficient for wideband services. Unlike some competing technologies, UMTS today offers users simultaneous voice and data. It also allows operators to support voice and data across their entire available spectrum.

HSPA has significantly enhanced UMTS by providing a broadband data service with user-achievable rates that often exceed 1 Mbps on the downlink in initial deployments and that now exceed 4 Mbps in some commercial networks. Many networks are now being upgraded to include HSUPA providing users uplink rates in excess of 1 Mbps.

Not only are there continual improvements in radio technology, but improvements to the core network through flatter architectures—particularly EPC/SAE—will reduce latency, speed applications, simplify deployment, enable all services in the IP domain, and allow a common core network to support both LTE and legacy GSM/UMTS systems.

HSPA and its advanced evolution can compete against any other technology in the world, and it is widely expected that most UMTS operators will eventually upgrade to this

technology. Other innovations, such as MIMO and higher order modulation, will be deployed over the next several years. Evolved HSPA+ systems, with peak rates of 42 Mbps, will largely match the throughput and capacity of OFDMA-based approaches in 5 MHz. 3GPP adopted OFDMA with 3GPP LTE, which will provide a growth platform for the next decade.

With the continued growth in mobile computing, powerful new handheld-computing platforms, an increasing amount of mobile content, multimedia messaging, mobile commerce, and location services, wireless data has slowly, but inevitably, become a huge industry. EDGE/HSPA/LTE provides one of the most robust portfolios of mobile-broadband technologies, and it is an optimum framework for realizing the potential of this market.

Appendix: Technology Details

The EDGE/HSPA/LTE family of data technologies provides ever-increasing capabilities that support ever more demanding applications. EDGE, now available globally, already makes a wealth of applications feasible including enterprise applications, messaging, e-mail, Web browsing, consumer applications, and even some multimedia applications. With UMTS and HSDPA, users are enjoying videophones, high-fidelity music, richer multimedia applications, and efficient access to their enterprise applications.

It is important to understand the needs enterprises and consumers have for these services. The obvious needs are broad coverage and high data throughput. Less obvious for users, but as critical for effective application performance, are the needs for low latency, QoS control, and spectral efficiency. Spectral efficiency, in particular, is of paramount concern, because it translates to higher average throughputs (and thus more responsive applications) for more active users in a coverage area. The discussion below, which examines each technology individually, details how the progression from EDGE to HSPA to LTE is one of increased throughput, enhanced security, reduced latency, improved QoS, and increased spectral efficiency.

It is also helpful to specifically note the throughput requirements necessary for different applications:

- ❑ Microbrowsing (for example, Wireless Application Protocol [WAP]): 8 to 128 kbps
- ❑ Multimedia messaging: 8 to 64 kbps
- ❑ Video telephony: 64 to 384 kbps
- ❑ General-purpose Web browsing: 32 kbps to more than 1 Mbps
- ❑ Enterprise applications including e-mail, database access, and VPNs: 32 kbps to more than 1 Mbps
- ❑ Video and audio streaming: 32 kbps to 2 Mbps

Note that EDGE already satisfies the demands of many applications. With HSPA, applications operate faster and the range of supported applications expands even further.

Under favorable conditions, EDGE delivers peak user-achievable throughput rates close to 200 kbps and initial deployments of HSPA deliver peak user-achievable downlink throughput rates of well over 1 Mbps, easily meeting the demands of many applications. Latency has continued to improve, too, with HSPA networks today having round-trip times as low as 70 msec. The combination of low latency and high throughput translates to a broadband experience for users, in which applications are extremely responsive.

In this section, we consider different technical approaches for wireless and the parallel evolution of 3GPP technologies. We then provide details on EDGE, UMTS/HSPA, HSPA+, LTE, and supporting technologies such as IMS.

EDGE

Today, most GSM networks support EDGE. It is an enhancement to GPRS, which is the original packet data service for GSM networks. GPRS provides a packet-based IP connectivity solution supporting a wide range of enterprise and consumer applications. GSM networks with EDGE operate as wireless extensions to the Internet and give users Internet access, as well as access to their organizations from anywhere. With peak user-

achievable⁸¹ throughput rates of up to 200 kbps with EDGE using four time-slot devices, users have the same effective access speed as a modem, but with the convenience of connecting from anywhere.

To understand the evolution of data capability, we briefly examine how these data services operate, beginning with the architecture of GSM and EDGE, as depicted in Figure 21.

Figure 21: GSM/GPRS/EDGE Architecture

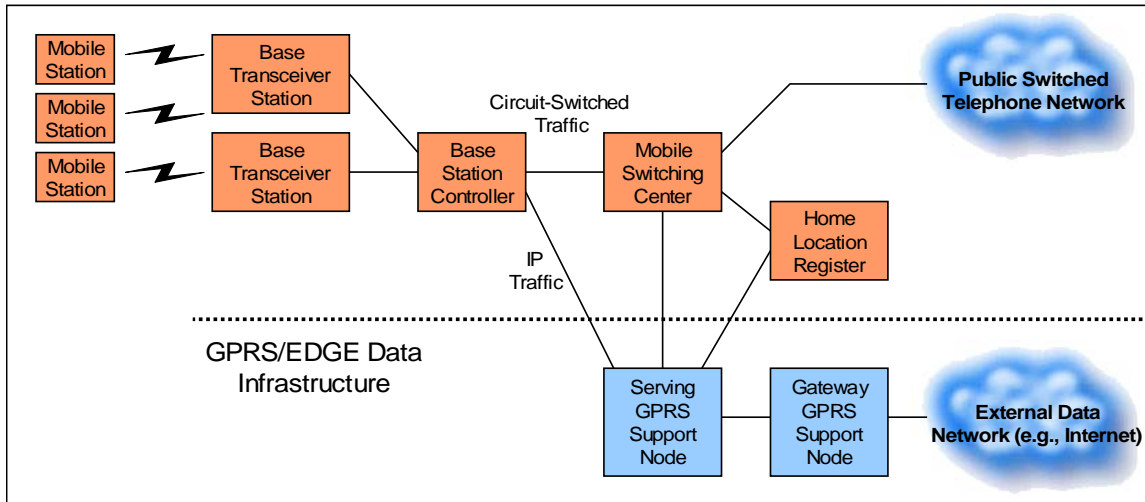

EDGE is essentially the addition of a packet-data infrastructure to GSM. In fact, this same data architecture is preserved in UMTS and HSPA networks, and it is technically referred to as GPRS for the core-data function in all these networks. The term GPRS may also be used to refer to the initial radio interface, now supplanted by EDGE. Functions of the data elements are as follows:

1. The base station controller directs/receives packet data to/from the SGSN, an element that authenticates and tracks the location of mobile stations.
2. The SGSN performs the types of functions for data that the MSC performs for voice. Each serving area has one SGSN, and it is often collocated with the MSC.
3. The SGSN forwards/receives user data to/from the GGSN, which can be viewed as a mobile IP router to external IP networks. Typically, there is one GGSN per external network (for example, the Internet). The GGSN also manages IP addresses, dynamically assigning them to mobile stations for their data sessions.

Another important element is the HLR, which stores users' account information for both voice and data services. Of significance is that this same data architecture supports data services in GSM and in UMTS/HSPA networks, thereby simplifying operator network upgrades.

In the radio link, GSM uses radio channels of 200 kilohertz (kHz) width, divided in time into eight timeslots comprising 577 microseconds (μs) that repeat every 4.6 msec, as shown in Figure 22. The network can have multiple radio channels (referred to as

⁸¹ "Peak user-achievable" means users, under favorable conditions of network loading and signal propagation, can achieve this rate as measured by applications such as file transfer. Average rates depend on many factors and will be lower than these rates.

transceivers) operating in each cell sector. The network assigns different functions to each timeslot such as the Broadcast Control Channel (BCCH), circuit-switched functions like voice calls or data calls, the optional Packet Broadcast Control Channel (PBCCH), and packet data channels. The network can dynamically adjust capacity between voice and data functions, and it can also reserve minimum resources for each service. This enables more data traffic when voice traffic is low or, likewise, more voice traffic when data traffic is low, thereby maximizing overall use of the network. For example, the PBCCH, which expands the capabilities of the normal BCCH, may be set up on a timeslot of a TDMA frame when justified by the volume of data traffic.

Figure 22: Example of GSM/EDGE Timeslot Structure⁸²

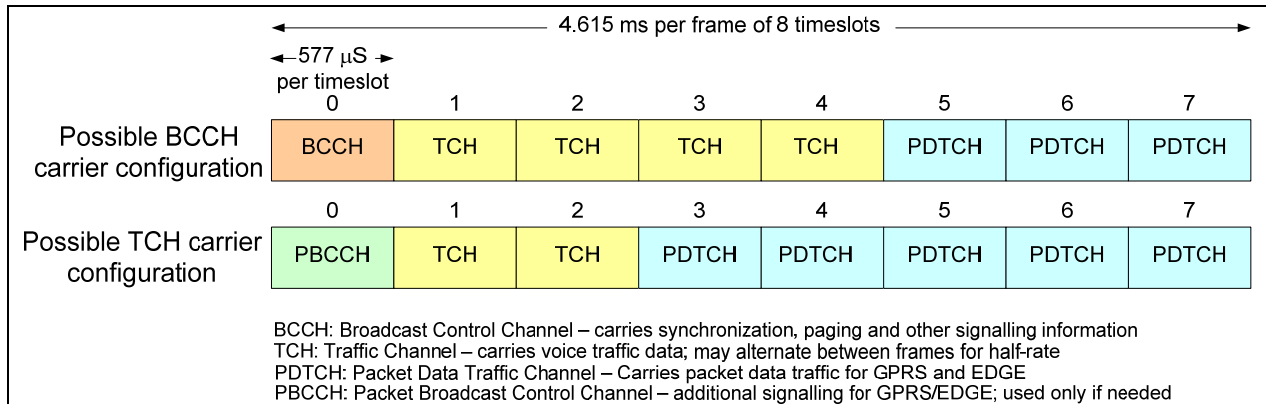

EDGE offers close coupling between voice and data services. In most networks, while in a data session, users can accept an incoming voice call, which suspends the data session, and then resume their data session automatically when the voice session ends. Users can also receive SMS messages and data notifications⁸³ while on a voice call. With networks supporting DTM, users with DTM-capable devices can engage in simultaneous voice/data operation.

With respect to data performance, each data timeslot can deliver peak user-achievable data rates of up to about 50 kbps. The network can aggregate up to four of these timeslots on the downlink with current devices.

Table 7 shows the different modulation and coding schemes for EDGE.

Table 7: EDGE Modulation and Coding Schemes⁸⁴

Modulation and Coding Scheme	Modulation	Throughput per Timeslot (kbps)
MCS-1	GMSK	8.8
MCS-2	GMSK	11.2
MCS-3	GMSK	14.8

⁸² Source: 3G Americas member company contribution.

⁸³ Example: WAP notification message delivered via SMS.

⁸⁴ Radio Link Control (RLC) – layer 2 - throughputs. Application rates are typically 20 percent lower.

Modulation and Coding Scheme	Modulation	Throughput per Timeslot (kbps)
MCS-4	GMSK	17.6
MCS-5	8-PSK	22.4
MCS-6	8-PSK	29.6
MCS-7	8-PSK	44.8
MCS-8	8-PSK	54.4
MCS-9	8-PSK	59.2

If multiple data users are active in a sector, they share the available data channels. As demand for data services increases, however, an operator can accommodate customers by assigning an increasing number of channels for data service that is limited only by that operator's total available spectrum and radio planning.

EDGE is an official 3G cellular technology that can be deployed within an operator's existing 850, 900, 1800, and 1900 MHz spectrum bands. EDGE capability is now largely standard in new GSM deployments. A GPRS network using the EDGE radio interface is technically called an Enhanced GPRS (EGPRS) network, and a GSM network with EDGE capability is referred to as GERAN. EDGE has been an inherent part of GSM specifications since Release 99. It is fully backward-compatible with older GSM networks, meaning that GPRS devices work on EDGE networks and that GPRS and EDGE terminals can operate simultaneously on the same traffic channels. In addition, any application developed for GPRS will work with EDGE.

Many operators that originally planned to use only UMTS for next-generation data services have deployed EDGE as a complementary 3G technology. There are multiple reasons for this including:

1. EDGE provides average data capabilities for the "sweet spot" of approximately 100 kbps, thereby enabling many communications-oriented applications.
2. EDGE has proven itself in the field as a cost-effective solution and is now a mature technology.
3. EDGE is spectrally efficient, thereby allowing operators to support large numbers of voice and data users in existing spectrum.
4. EDGE provides a cost-effective wide-area data service that offers continuity and is complementary with a UMTS/HSPA network deployed in high traffic areas.

It is important to note that EDGE technology is continuing to improve. For example, Release 4 significantly reduced EDGE latency (network round-trip time)—from the typical 500 to 600 msec to about 300 msec. Operators also continue to make improvements in how EDGE functions, including network optimizations that boost capacity and reduce latency. The impact for users is that EDGE networks today are more robust with applications functioning more responsively. Release 7's Evolved EDGE will also introduce significant new features.

Devices themselves are increasing in capability. Dual Transfer Mode (DTM) devices, already available from vendors, allow simultaneous voice and data communications. For example, during a voice call, users will be able to retrieve e-mail, do multimedia

messaging, browse the Web, and do Internet conferencing. This is particularly useful when connecting phones to laptops via cable or Bluetooth and using them as modems.

DTM is a 3GPP-specified technology that enables new applications like video sharing while providing a consistent service experience (service continuity) with UMTS. Typically, a DTM end-to-end solution requires only a software upgrade to the GSM/EDGE radio network. There are a number of networks and devices now supporting DTM.

Although HSPA networks provide an even better user experience for some applications, the fact is that many applications—such as e-mail on smartphones—are served perfectly well by EDGE. Combining the efficiency of EDGE for data with the efficiency of GSM for voice, operators can use GSM technology to deliver a broad range of services that will satisfy their customers for many years.

Evolved EDGE

Recognizing the value of the huge installed base of GSM networks, 3GPP is currently working to improve EDGE capabilities for Release 7. This work is part of the GERAN Evolution effort, which also includes voice enhancements not discussed in this paper.

Although EDGE today already serves many applications like wireless e-mail extremely well, it makes good sense to continue to evolve EDGE capabilities. From an economic standpoint, it is less costly than upgrading to UMTS, because most enhancements are designed to be software based, and it is highly asset efficient, because it involves fewer long-term capital investments to upgrade an existing system. With 85 percent of the world market using GSM, which is already equipped for simple roaming and billing, it is easy to offer global service to subscribers. Evolved EDGE offers higher data rates and system capacity, and cable-modem speeds are realistically achievable.

In addition, many regions do not have licensed spectrum for deployment of a new radio technology such as UMTS/HSPA or LTE. Also, Evolved EDGE also provides better service continuity between EDGE and HSPA, meaning that a user will not have a hugely different experience when moving between environments.

Although GSM and EDGE are already highly optimized technologies, advances in radio techniques will enable further efficiencies. Some of the objectives of Evolved EDGE include:

- ❑ A 100 percent increase in peak data rates.
- ❑ A 50 percent increase in spectral efficiency and capacity in C/I-limited scenarios.
- ❑ A sensitivity increase in the downlink of 3 dB for voice and data.
- ❑ A reduction of latency for initial access and round-trip time, thereby enabling support for conversational services such as VoIP and PoC.
- ❑ To achieve compatibility with existing frequency planning, thus facilitating deployment in existing networks.
- ❑ To coexist with legacy mobile stations by allowing both old and new stations to share the same radio resources.
- ❑ To avoid impacts on infrastructure by enabling improvements through a software upgrade.
- ❑ To be applicable to DTM (simultaneous voice and data) and the A/Gb mode interface. The A/Gb mode interface is part of the 2G core network, so this goal is required for full backward-compatibility with legacy GPRS/EDGE.

The methods standardized in Release 7 to achieve these objectives include:

- ❑ Downlink dual-carrier reception to increase the number of timeslots that can be received without a need to receive and transmit on the same carrier from four on one carrier to 10 on two carriers for a 150 percent increase in throughput.
- ❑ The addition of Quadrature Phase Shift Keying (QPSK), 16 QAM, and 32 QAM as well as an increased symbol rate (1.2x) in the uplink and a new set of modulation/coding schemes that will increase maximum throughput per timeslot by 38 percent. Currently, EDGE uses 8-PSK modulation. Simulations indicate a realizable 25 percent increase in user-achievable peak rates.
- ❑ A reduction in overall latency. This is achieved by lowering the TTI to 10 msec and by including the acknowledgement information in the data packet. These enhancements will have a dramatic effect on throughput for many applications.
- ❑ Downlink diversity reception of the same radio channel to increase the robustness in interference and to improve the receiver sensitivity. Simulations have demonstrated sensitivity gains of 3 dB and a decrease in required C/I of up to 18 dB for a single cochannel interferer. Significant increases in system capacity can be achieved, as explained below.

Dual-Carrier Receiver

A key part of the evolution of EDGE is the utilization of more than one radio frequency carrier. This overcomes the inherent limitation of the narrow channel bandwidth of GSM. Using two radio-frequency carriers requires two receiver chains in the downlink, as shown in Figure 23. As previously stated, using two carriers enables the reception of more than twice as many radio blocks simultaneously.

Figure 23: Evolved EDGE Two-Carrier Operation⁸⁵

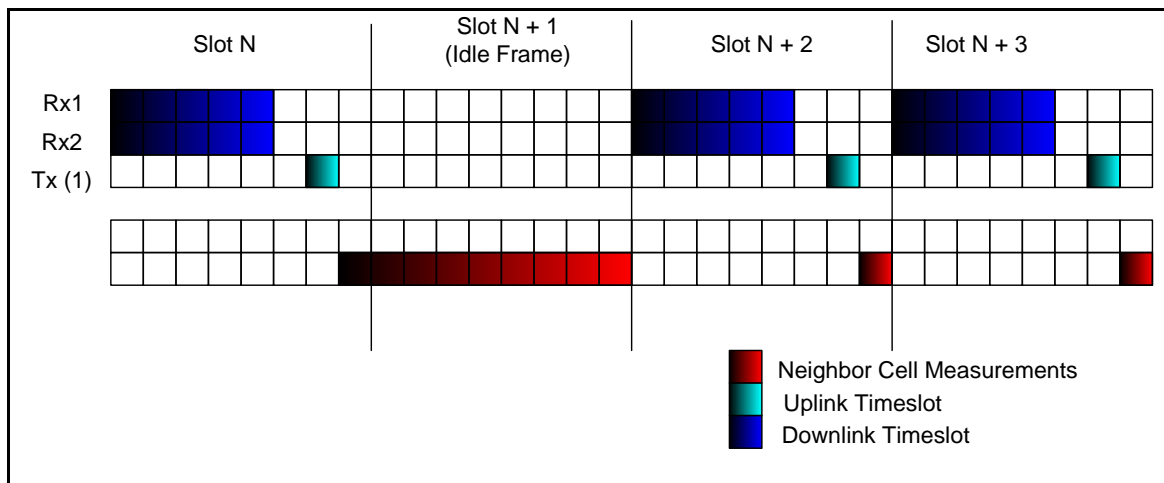

Alternatively, the original number of radio blocks can be divided between the two carriers. This eliminates the need for the network to have contiguous timeslots on one frequency.

⁸⁵ Source: 3G Americas member company contribution.

Figure 24: EDGE Multi-Carrier Receive Logic – Mobile Part⁸⁶

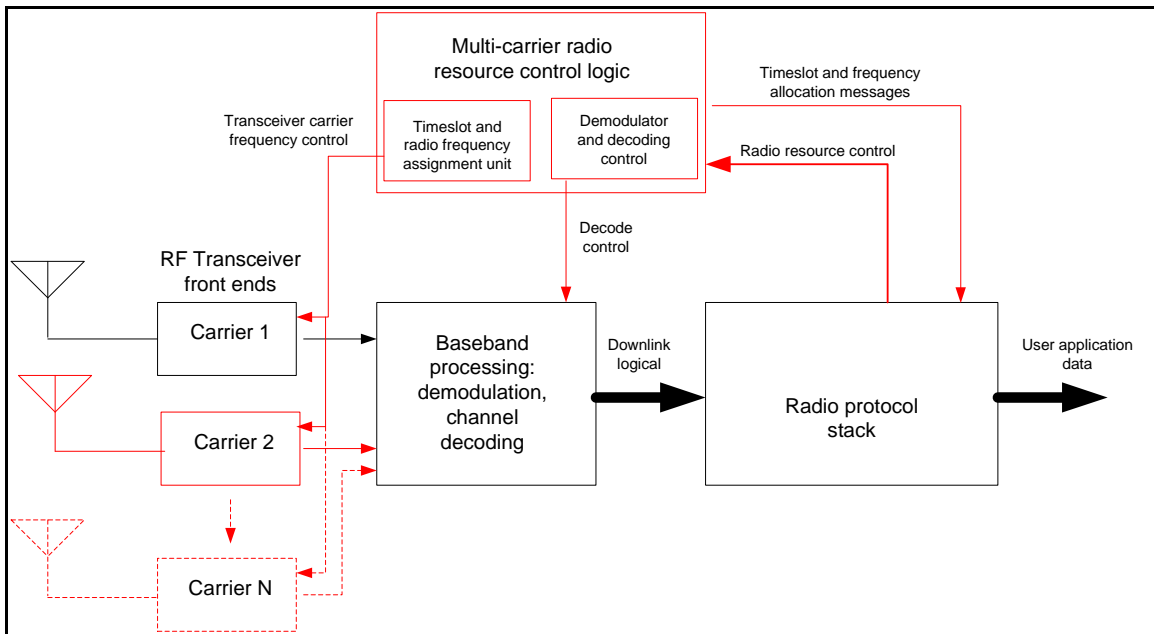

Channel capacity with dual-carrier reception improves greatly, not by increasing basic efficiencies of the air interface, but because of statistical improvement in the ability to assign radio resources, which increases trunking efficiency.

As network loading increases, it is statistically unlikely that contiguous timeslots will be available. With today's EDGE devices, it is not possible to change radio frequencies when going from one timeslot to the next. With an Evolved EDGE dual receiver, however, this becomes possible, thus enabling contiguous timeslots across different radio channels. The result is that the system can allocate a large set of time slots for data even if they are not contiguous, which otherwise is not possible. Figure 25 shows why this is important. As the network becomes busy, the probability of being assigned 1 timeslot decreases. As this probability decreases (X axis), the probability of being able to obtain 5 timeslots on the same radio carrier decreases dramatically. Being able to obtain timeslots across two carriers in Evolved EDGE, however, significantly improves the likelihood of obtaining the desired timeslots.

⁸⁶ Source: 3G Americas member company contribution.

Figure 25: Probabilities of Time Slot Assignments⁸⁷

Probability of Same Carrier Timeslot Assignment

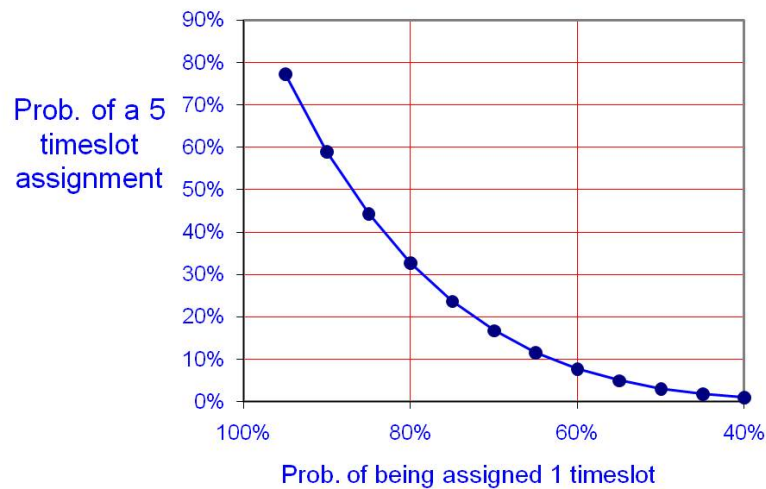
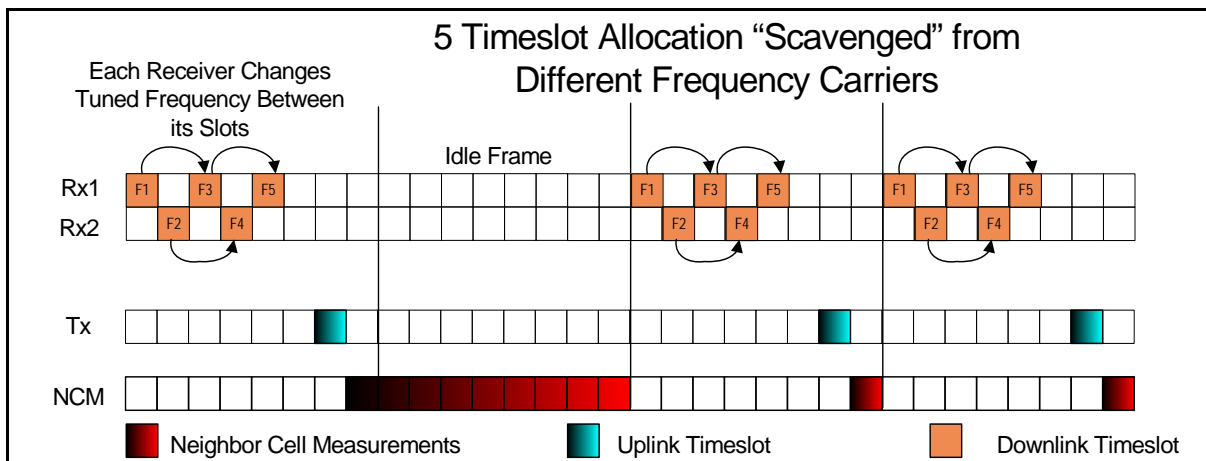

Figure 26 shows a dual-radio receiver approach optimizing the use of available timeslots. (“Rx1” refers to receiver 1, “Rx2” refers to receiver 2, “NCM” refers to neighbour cell monitoring, and “M2” refers to receiver 2 doing system monitoring.)

Figure 26: Optimization of Timeslot Usage Example⁸⁸



Through intelligent selection, a dual-carrier receiver architecture can support either dual-carrier reception or mobile-station receive diversity, depending on the operating environment.

Mobile Station Receive Diversity

⁸⁷ Source: 3G Americas member company contribution.

⁸⁸ Source: 3G Americas member company contribution.

Figure 27 illustrates how mobile-station receive diversity increases system capacity. (BCCH refers to the Broadcast Control Channel and TCH refers to the Traffic Channel.) The BCCH carrier repeats over 12 cells in a 4/12 frequency reuse pattern, which requires 2.4 MHz for GSM. A fractionally loaded system may repeat f12 through f15 on each of the cells. This is a 1/1 frequency reuse pattern with higher system utilization, but also potentially high co-channel interference in loaded conditions.

Figure 27: Example of 4/12 Frequency Reuse with 1/1 Overlay⁸⁹

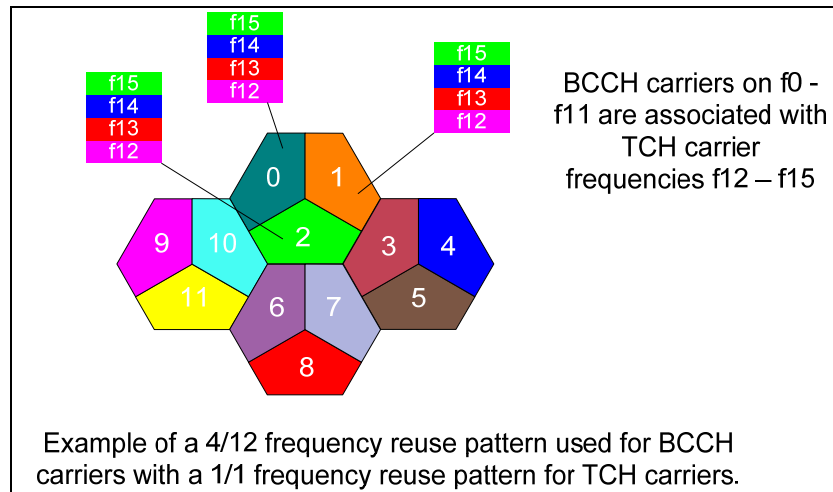

In today's EDGE systems, f12 through f15 in the 1/1 reuse layer can only be loaded to around 25 percent of capacity. Thus, with four of these frequencies, it is possible to obtain 100 percent of the capacity of the frequencies in the 4/12 reuse layer or to double the capacity by adding 800 KHz of spectrum.

Using Evolved EDGE and receive-diversity-enabled mobile devices that have a high tolerance to co-channel interference, however, it is possible to increase the load on the 1/1 layer from 25 to 50 percent and possibly to as high as 75 percent. An increase to 50 percent translates to a doubling of capacity on the 1/1 layer without requiring any new spectrum and to a 200 percent gain compared to a 4/12 reuse layer.

Higher Order Modulation and Higher Symbol Rate Schemes

The addition of higher order modulation schemes enhances EDGE network capacity with little capital investment by extending the range of the existing wireless technology. More bits-per-symbol means more data transmitted per unit time. This yields a fundamental technological improvement in information capacity and faster data rates. Use of higher order modulation exploits localized optimal coverage circumstances, thereby taking advantage of the geographical locations associated with probabilities of high C/I ratio and enabling very high data transfer rates whenever possible.

These enhancements are only now being considered, because factors such as processing power, variability of interference, and signal level made higher order modulations impractical for mobile wireless systems just a few years ago. Newer techniques for demodulation, however, such as advanced receivers and receive diversity, help enable their use.

⁸⁹ Source: 3G Americas member company contribution.

Two different levels of support for higher order modulation are defined for both the uplink and the downlink. In the uplink, the first support level includes GMSK, 8-PSK, and 16 QAM at the legacy symbol rate. This level of support reuses Modulation and Coding Schemes (MCSs) 1 through 6 from EGPRS and adds five new 16 QAM modulated schemes called uplink "A" level schemes (UAS).

Table 8: Uplink Modulation and Coding Schemes

Modulation and Coding Scheme Name	Uplink EGPRS2 Support Level A	
	Modulation Type	Peak Throughput (kbps) – 4 slots
MCS-1	GMSK	35.2
MCS-2	GMSK	44.8
MCS-3	GMSK	59.2
MCS-4	GMSK	70.4
MCS-5	8-PSK	89.6
MCS-6	8-PSK	118.4
UAS-7	16 QAM	179.2
UAS-8	16 QAM	204.8
UAS-9	16 QAM	236.8
UAS-10	16 QAM	268.8
UAS-11	16 QAM	307.2

The second support level in the uplink includes QPSK, 16 QAM, and 32 QAM modulation as well as a higher (1.2x) symbol rate. MCSs 1 through 4 from EGPRS are reused, and eight new uplink "B" level schemes (UBS) are added.

Table 9: Uplink Modulation and Coding Schemes with Higher Symbol Rate

Modulation and Coding Scheme Name	Uplink EGPRS2 Support Level B	
	Modulation Type	Peak Throughput (kbps) – 4 slots
MCS-1	GMSK	35.2
MCS-2	GMSK	44.8
MCS-3	GMSK	59.2
MCS-4	GMSK	70.4
UBS-5	QPSK	89.6
UBS-6	QPSK	118.4
UBS-7	16 QAM	179.2
UBS-8	16 QAM	236.8

UBS-9	16 QAM	268.8
UBS-10	32 QAM	355.2
UBS-11	32 QAM	435.2
UBS-12	32 QAM	473.6

The first downlink support level introduces a modified set of 8-PSK coding schemes and adds 16 QAM, and 32 QAM all at the legacy symbol rate. Turbo codes are used for all new modulations. MCSs 1 through 4 are reused, and eight new downlink "A" level schemes (DAS) are added.

Table 10: Downlink Modulation and Coding Schemes

Modulation and Coding Scheme Name	Downlink HOM/HSR Support Level A	
	Modulation Type	Peak Throughput (kbps) – 4 slots
MCS-1	GMSK	35.2
MCS-2	GMSK	44.8
MCS-3	GMSK	59.2
MCS-4	GMSK	70.4
DAS-5	8-PSK	89.6
DAS-6	8-PSK	108.8
DAS-7	8-PSK	131.2
DAS-8	16 QAM	179.2
DAS-9	16 QAM	217.6
DAS-10	32 QAM	262.0
DAS-11	32 QAM	326.4
DAS-12	32 QAM	393.6

The second downlink support level includes QPSK, 16 QAM, and 32 QAM modulations at a higher (1.2x) symbol rate. MCSs 1 through 4 are reused, and eight new downlink "B" level schemes (DBS) are defined.

Table 11: Downlink Modulation and Coding Schemes with Higher Symbol Rate⁹⁰

Modulation and Coding Scheme Name	Downlink HOM/HSR Support Level B	
	Modulation Type	Peak Throughput (kbps) – 4 slots
MCS-1	GMSK	35.2

⁹⁰ These data rates require a wide-pulse shaping filter that is not part of Release 7.

MCS-2	GMSK	44.8
MCS-3	GMSK	59.2
MCS-4	GMSK	70.4
DBS-5	QPSK	89.6
DBS-6	QPSK	118.4
DBS-7	16 QAM	179.2
DBS-8	16 QAM	236.8
DBS-9	16 QAM	268.8
DBS-10	32 QAM	355.2
DBS-11	32 QAM	435.2
DBS-12	32 QAM	473.6

The combination of Release 7 EDGE Evolution enhancements shows a dramatic potential increase in throughput. For example, in the downlink, a Type 2 mobile device (one that can support simultaneous transmission and reception) using DBS-12 as the MCS and a dual-carrier receiver can achieve the following performance:

Highest data rate per timeslot (layer 2) = 118.4 kbps

Timeslots per carrier = 8

Carriers used in the downlink = 2

Total downlink data rate = 118.4 kbps X 8 X 2 = 1894.4 kbps⁹¹

This translates to a peak network rate close to 2 Mbps and a user-achievable data rate of well over 1 Mbps!

Other Methods Under Consideration

This paper has emphasized those Evolved EDGE features that 3GPP has agreed upon for Release 7. However, there are other features being proposed that would boost EDGE capabilities even further.

Advanced modulation enhancements include the addition of turbo coding and 64 QAM to the higher order modulation enhancements already described. These enhancements increase the robustness of the channel and take advantage of local areas of high C/I ratios.

A second uplink carrier could also double uplink throughput. Two approaches have been discussed. The first is a fully flexible dual-transmitter approach. This approach has no impact on the network, but may have significant impact on the feasibility of the mobile station, particularly in the handheld form factor; it is currently being researched and discussed. The second approach is a constrained form of uplink dual carrier in which the spacing of the two carriers is less than 1 MHz and a single wideband transmitter generates the signal. This approach is easier to implement in a mobile handset, but it may impact legacy frequency planning. Proposals have been put forward outlining ways

⁹¹ For the near future, two carriers will be a scenario more practically realized on a notebook computer platform than handheld platforms.

to coexist with legacy frequency planning; these ideas are being researched and discussed.

Evolved EDGE Implementation

Table 12 shows what is involved in implementing the different features defined for Evolved EDGE. For a number of features, there are no hardware changes required for the base transceiver station (BTS). For all features, Evolved EDGE is compatible with legacy frequency planning.

Table 12: Evolved EDGE Implementation⁹²

Coexistence and Implementation Matrix Evolved EDGE Features with Current Networks and Mobile Stations	Coexistence with Legacy Frequency Planning	Will Operation of Legacy MS be effected?	BTS Hardware Impact?	Mobile Station Impact?	Core Network Impact?
Receiver Diversity in the Mobile Station	Yes	No	No Impact	Hardware Change	None
Downlink Dual Carrier	Yes	No	No Impact	Hardware Change	None
Higher Order Modulation	Yes	No	Most Recent TRX are Capable	HW and SW Change or SW Change only	None
Higher Order Modulation and Increased Symbol Rate	Yes	No	New TRX Required	HW Change Likely	None
Latency Reduction	Yes	No	No Impact	Software Change	None

In conclusion, it is interesting to note the sophistication and capability that is achievable with, and planned for, GSM.

UMTS/HSPA Technology

UMTS has garnered the overwhelming majority of new 3G spectrum licenses with 236 commercial networks already in operation.⁹³ Compared to emerging wireless technologies, UMTS technology is mature and benefits from research and development that began in the early 1990s. It has been thoroughly trialed, tested, and commercially deployed. UMTS deployment is now accelerating with stable network infrastructures and attractive, reliable mobile devices that have rich capabilities. With the addition of HSPA for high-speed packet data services, UMTS/HSPA is quickly emerging as the dominant global mobile-broadband network.

UMTS employs a wideband CDMA radio-access technology. The primary benefits of UMTS include high spectral efficiency for voice and data, simultaneous voice and data capability for users, high user densities that can be supported with low infrastructure

⁹² Source: 3G Americas member company contribution.

⁹³ "World Cellular Information Service," Informa Telecoms & Media, June 2008.

costs, support for high-bandwidth data applications, and a clean migration to VoIP in the future. Operators can also use their entire available spectrum for both voice and high-speed data services.

Additionally, operators can use a common core network that supports multiple radio-access networks including GSM, EDGE, WCDMA, HSPA, and evolutions of these technologies. This is called the UMTS multiradio network, and it gives operators maximum flexibility in providing different services across their coverage areas (see Figure 28).

Figure 28: UMTS Multiradio Network

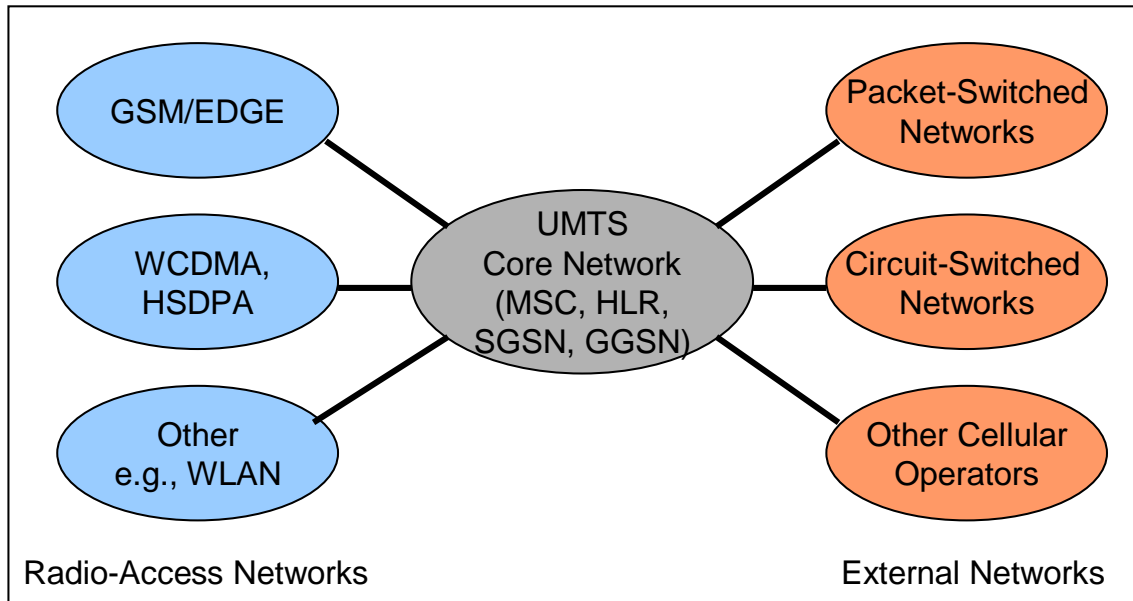

The UMTS radio-access network consists of base stations referred to as Node B (corresponding to GSM base transceiver systems) that connect to RNCs (corresponding to GSM base station controllers [BSCs]). The RNCs connect to the core network as do the BSCs. When both GSM and WCDMA access networks are available, the network can hand over users between these networks. This is important for managing capacity, as well as in areas in which the operator has continuous GSM coverage, but has only deployed WCDMA in some locations.

Whereas GSM can effectively operate like a spread-spectrum system⁹⁴, based on time division in combination with frequency hopping, WCDMA is a direct-sequence, spread-spectrum system. WCDMA is spectrally more efficient than GSM, but it is the wideband nature of WCDMA that provides its greatest advantage—the ability to translate the available spectrum into high data rates. This wideband technology approach results in the flexibility to manage multiple traffic types including voice, narrowband data, and wideband data.

WCDMA allocates different codes for different channels, whether for voice or data, and it can adjust the amount of capacity, or code space, of each channel every 10 msec with WCDMA Release 99 and every 2 msec with HSPA. WCDMA creates high-bandwidth traffic channels by reducing the amount of spreading (using a shorter code) with WCDMA

⁹⁴ Spread spectrum systems can either be direct sequence or frequency hopping.

Release 99 and higher order modulation schemes for HSPA. Packet data users can share the same codes as other users, or the network can assign dedicated channels to users.

To further expand the number of effectively operating applications, UMTS employs a sophisticated QoS architecture for data that provides four fundamental traffic classes including:

1. **Conversational.** Real-time interactive data with controlled bandwidth and minimum delay such as VoIP or video conferencing.
2. **Streaming.** Continuous data with controlled bandwidth and some delay such as music or video.
3. **Interactive.** Back-and-forth data without bandwidth control and some delay such as Web browsing.
4. **Background.** Lower priority data that is non-real-time such as batch transfers.

This QoS architecture involves negotiation and prioritization of traffic in the radio-access network, the core network, and the interfaces to external networks such as the Internet. Consequently, applications can negotiate QoS parameters on an end-to-end basis between a mobile terminal and a fixed-end system across the Internet or private intranets. This capability is essential for expanding the scope of supported applications, particularly multimedia applications including packetized video telephony and VoIP.

UMTS Release 99 Data Capabilities

Initial UMTS network deployments were based on 3GPP Release 99 specifications, which included voice and data capabilities. Since then, Release 5 has defined HSDPA and Release 6 has defined HSUPA. With HSPA-capable devices, the network uses HSPA (HSDPA/HSUPA) for data. Operators with Release 99 networks are upgrading them to Release 5 or Release 6. Because Release 99 networks and devices are still in the field, this section describes the data service available with Release 99. In advance of Release 6, the uplink in HSDPA (Release 5) networks uses the Release 99 approach.

In UMTS Release 99, the maximum theoretical downlink rate is just over 2 Mbps. Although exact throughput depends on the channel sizes the operator chooses to make available, the capabilities of devices, and the number of users active in the network limit the peak throughput rates a user can achieve to about 350 kbps in commercial networks. Peak downlink network speeds are 384 kbps. Uplink peak-networkthroughput rates are also 384 kbps in newer deployments, with user-achievable peak rates of 350 kbps.⁹⁵ This satisfies many communications-oriented applications.

Channel throughputs are determined by the amount of channel spreading. With more spreading, as in voice channels, the data stream has greater redundancy, and the operator can employ more channels. In comparison, a high-speed data channel has less spreading and fewer available channels. Voice channels use downlink spreading factors of 128 or 256, whereas a 384 kbps data channel uses a downlink spreading factor of 8. The commonly quoted rate of more than 2 Mbps downlink throughput for UMTS can be achieved by combining three data channels of 768 kbps, each with a spreading factor of 4.

⁹⁵ Initial UMTS networks had peak uplink rates of 64 kbps or 128 kbps, but many deployments emphasize 384 kbps.

The actual throughput speeds a user can obtain with WCDMA Release 99 depend on the Radio Access Bearer (RAB) assigned by the network. Possible values include 768, 384, 128, 64, 32, and 16 kbps. The different rates correspond to the amount of spreading. A lower degree of spreading results in more code space assigned to that RAB; hence, higher throughput. In today's Release 99 networks, operators have limited the range of operational data rates using Release 99 channels to 384 kbps as a result of the emergence of HSDPA, which provides a much more elegant way to reach data throughput in the 2 Mbps range and higher.

Beyond the maximum throughput supported by the RAB assigned by the network, user throughput is also impacted by the radio conditions and the amount of data to transfer. The RAN takes these elements into account to continuously adjust the instantaneous transfer rate based on operational conditions and within the QoS constraints of the RAB. The network assigns RABs based on available resources. How the network assigns RABs varies by infrastructure vendor.

WCDMA has lower network latency than EDGE, with about 100 to 200 msec measured in actual networks. Although UMTS Release 99 offers attractive data services, these services become much more efficient and more powerful with HSPA.

HSDPA

HSPA refers to networks that support both HSDPA and HSUPA. Most new deployments today are HSPA, and many operators are upgrading their HSDPA networks to HSPA. For example, in 2008, AT&T had upgraded most of its network to HSPA. By the end of 2008, HSPA will be deployed throughout the Americas. This section covers technical aspects of HSDPA, while the next section covers HSUPA.

HSDPA, specified in 3GPP Release 5, is a high-performance packet-data service that delivers peak theoretical rates of 14 Mbps. Peak user-achievable throughput rates in initial deployments are well over 1 Mbps, and as high as 4 Mbps in some networks. HSDPA is fully backward-compatible with UMTS Release 99, and any application developed for Release 99 will work with HSDPA. The same radio carrier can simultaneously service UMTS voice and data users as well as HSDPA data users. HSDPA also has significantly lower latency, measured today on some networks as low as 70 msec on the data channel.

HSDPA achieves its high speeds through techniques similar to those that push EDGE performance past GPRS including higher order modulation, variable coding, and soft combining, as well as through the addition of powerful new techniques such as fast scheduling. HSDPA elevates the performance level of WCDMA technology to provide broadband services, and it has the highest theoretical peak throughput of any cellular technology currently available. The higher spectral efficiency and higher data rates not only enable new classes of applications, but also support a greater number of users accessing the network.

HSDPA achieves its performance gains from the following radio features:

- ❑ High-speed channels shared in both code and time domains
- ❑ Short TTI
- ❑ Fast scheduling and user diversity
- ❑ Higher order modulation
- ❑ Fast link adaptation

Figure 30: User Diversity

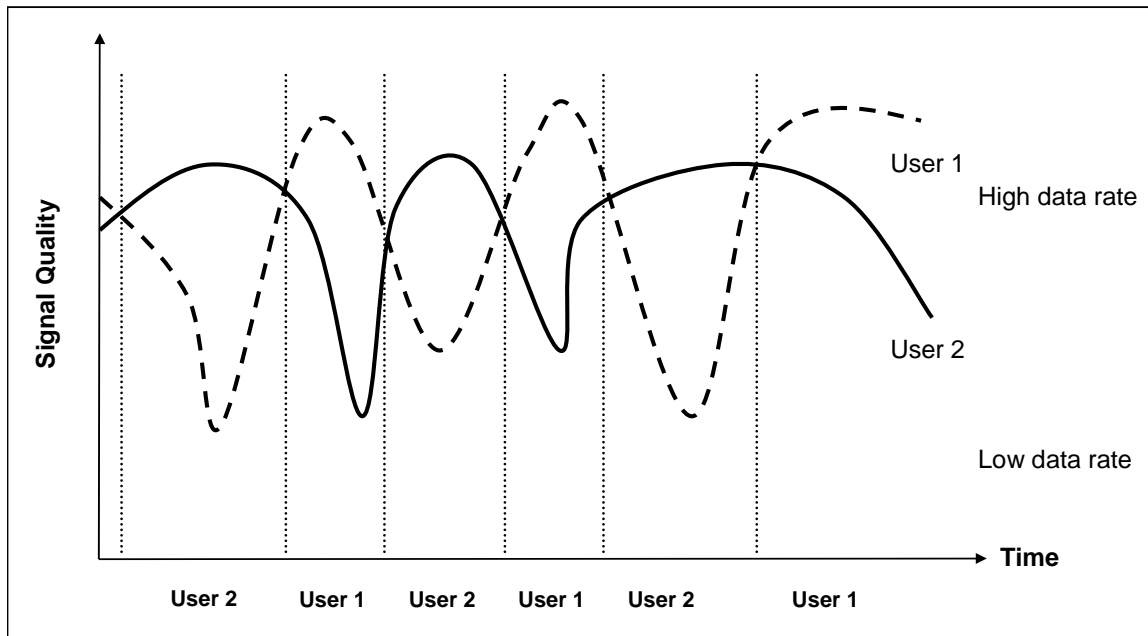

Higher Order Modulation: HSDPA uses both the modulation used in WCDMA—namely QPSK—and, under good radio conditions, an advanced modulation scheme—16 QAM. The benefit of 16 QAM is that 4 bits of data are transmitted in each radio symbol as opposed to 2 bits with QPSK. Data throughput is increased with 16 QAM, while QPSK is available under adverse conditions. HSPA Evolution will add 64 QAM modulation to further increase throughput rates. Note that 64QAM was available in Release 7 and the combination of MIMO and 64QAM will be in Release 8.

Fast Link Adaptation: Depending on the condition of the radio channel, different levels of forward-error correction (channel coding) can also be employed. For example, a three-quarter coding rate means that three quarters of the bits transmitted are user bits and one quarter are error-correcting bits. The process of selecting and quickly updating the optimum modulation and coding rate is referred to as fast link adaptation. This is done in close coordination with fast scheduling, as described above.

Fast Hybrid Automatic Repeat Request: Another HSDPA technique is Fast Hybrid Automatic Repeat Request (Fast Hybrid ARQ). “Fast” refers to the medium-access control mechanisms implemented in Node B (along with scheduling and link adaptation), as opposed to the BSC in GPRS/EDGE, and “hybrid” refers to a process of combining repeated data transmissions with prior transmissions to increase the likelihood of successful decoding. Managing and responding to real-time radio variations at the base station, as opposed to an internal network node, reduces delays and further improves overall data throughput.

Using the approaches just described, HSDPA maximizes data throughputs and capacity and minimizes delays. For users, this translates to better network performance under loaded conditions, faster application performance, a greater range of applications that function well, and increased productivity.

Field results validate the theoretical throughput results. With initial 1.8 Mbps peak-rate devices, vendors measured consistent throughput rates in actual deployments of over 1 Mbps. These rates rose to over 2 Mbps for 3.6 Mbps devices and are close to 4 Mbps for

7.2 Mbps devices, assuming other portions of the network (for example, backhaul) can support the high throughput rates.

In 2008, typical devices supporting peak data rates of 3.6 Mbps or 7.2 Mbps became available. Many operator networks support 7.2 Mbps peak operation, and some even support the maximum rate of 14.4 Mbps.

Table 13 defines the different categories of HSDPA devices. (Soft channel bits are the number of bits the system uses for error correction.)

Table 13: HSDPA Terminal Categories

HS-DSCH Category	Maximum Number of HS-DSCH codes	L1 Peak Rate (Mbps)	QPSK/16QAM	Soft Channel Bits
Category 1	5	1.2	Both	19200
Category 2	5	1.2	Both	28800
Category 3	5	1.8	Both	28800
Category 4	5	1.8	Both	38400
Category 5	5	3.6	Both	57600
Category 6	5	3.6	Both	67200
Category 7	10	7.2	Both	115200
Category 8	10	7.2	Both	134400
Category 9	15	10.2	Both	172800
Category 10	15	14.4	Both	172800
Category 11	5	0.9	QPSK	14400
Category 12	5	1.8	QPSK	28800

HSPA technology is not standing still. Advanced radio technologies are becoming available. Among these technologies are mobile-receive diversity and equalization (for example, MMSE), which improve the quality of the received radio signal prior to demodulation and decoding. This improvement enables not only higher peak HSDPA throughput speeds, but makes these speeds available over a greater percentage of the coverage area.

HSUPA

Whereas HSDPA optimizes downlink performance, HSUPA—which uses the Enhanced Dedicated Channel (E-DCH)—constitutes a set of improvements that optimizes uplink performance. Networks and devices supporting HSUPA became available in 2007. These improvements include higher throughputs, reduced latency, and increased spectral efficiency. HSUPA is standardized in Release 6. It results in an approximately 85 percent increase in overall cell throughput on the uplink and more than 50 percent gain in user throughput. HSUPA also reduces packet delays, a significant benefit resulting in significantly improved application performance on HSPA networks

Although the primary downlink traffic channel supporting HSDPA serves is a shared channel designed for the support of services delivered through the packet-switched domain, the primary uplink traffic channel defined for HSUPA is a dedicated channel that could be used for services delivered through either the circuit-switched or the packet-switched domains. Nevertheless, by extension and for simplicity, the WCDMA-enhanced uplink capabilities are often identified in the literature as HSUPA.

Such an improved uplink benefits users in a number of ways. For instance, some user applications transmit large amounts of data from the mobile station such as sending video clips or large presentation files. For future applications like VoIP, improvements will balance the capacity of the uplink with the capacity of the downlink.

HSUPA achieves its performance gains through the following approaches:

- ❑ An enhanced dedicated physical channel
- ❑ A short TTI, as low as 2 msec, which allows faster responses to changing radio conditions and error conditions
- ❑ Fast Node B-based scheduling, which allows the base station to efficiently allocate radio resources
- ❑ Fast Hybrid ARQ, which improves the efficiency of error processing

The combination of TTI, fast scheduling, and Fast Hybrid ARQ also serves to reduce latency, which can benefit many applications as much as improved throughput. HSUPA can operate with or without HSDPA in the downlink, though it is likely that most networks will use the two approaches together. The improved uplink mechanisms also translate to better coverage and, for rural deployments, larger cell sizes.

HSUPA can achieve different throughput rates based on various parameters including the number of codes used, the spreading factor of the codes, the TTI value, and the transport block size in bytes, as illustrated in Table 14.

Table 14: HSUPA Peak Throughput Rates

HSUPA Category	Codes x Spreading	TTI	Transport Block Size	Data Rate
1	1 x SF4	10	7296	0.73 Mbps
2	2 x SF4	10	14592	1.46 Mbps
2	2 x SF4	2	2919	1.46 Mbps
3	2 x SF4	10	14592	1.46 Mbps
4	2 x SF2	10	20000	2 Mbps
4	2 x SF2	2	5837	2.9 Mbps
5	2 x SF2	10	20000	2 Mbps
6	2xSF2 + 2xSF4	10	20000	2 Mbps
6	2xSF2 + 2xSF4	2	11520	5.76 Mbps

Initial devices are Category 5 enabling peak user rates of close to 2 Mbps as measured in actual network deployments. Category 6 devices will ultimately allow speeds close to 5 Mbps, although only with the addition of interference cancellation methods that boost SNR.

Beyond throughput enhancements, HSUPA also significantly reduces latency. In optimized networks, latency will fall below 50 msec, relative to current HSDPA networks at 70 msec. And with a later introduction of a 2 msec TTI, latency will be as low as 30 msec.

Evolution of HSPA (HSPA+)

OFDMA systems have attracted considerable attention through technologies such as 3GPP LTE, WiMAX, and UMB. As already discussed in this paper, however, CDMA approaches can match OFDMA approaches in reduced channel bandwidths. The goal in evolving HSPA is to exploit available radio technologies—largely enabled by increases in digital signal processing power—to maximize CDMA-based radio performance. This not only makes HSPA competitive, it significantly extends the life of sizeable operator infrastructure investments.

Wireless and networking technologists have defined a series of enhancements for HSPA, some of which are specified in Release 7 and some of which are being finalized in Release 8. These include advanced receivers, MIMO, Continuous Packet Connectivity, Higher-Order Modulation and One Tunnel Architecture.

Advanced Receivers

One important area is advanced receivers for which 3GPP has specified a number of advanced designs. These designs include Type 1, which uses mobile-receive diversity; Type 2, which uses channel equalization; and Type 3, which includes a combination of receive diversity and channel equalization. Type 3i devices, which are not yet available, will employ interference cancellation. Note that the different types of receivers are release-independent. For example, Type 3i receivers will work and provide a capacity gain in a Release 5 network.

The first approach is mobile-receive diversity. This technique relies on the optimal combination of received signals from separate receiving antennas. The antenna spacing yields signals that have somewhat independent fading characteristics. Hence, the combined signal can be more effectively decoded, which results in an almost doubling of downlink capacity when employed in conjunction with techniques such as channel equalization. Receive diversity is effective even for small devices such as PC Card modems and smartphones.

Current receiver architectures based on rake receivers are effective for speeds up to a few megabits per second. But at higher speeds, the combination of reduced symbol period and multipath interference results in inter-symbol interference and diminishes rake receiver performance. This problem can be solved by advanced-receiver architectures with channel equalizers that yield additional capacity gains over HSDPA with receive diversity. Alternate advanced-receiver approaches include interference cancellation and generalized rake receivers (G-Rake). Different vendors are emphasizing different approaches. The performance requirements for advanced-receiver architectures, however, are specified in 3GPP Release 6. The combination of mobile-receive diversity and channel equalization (Type 3) is especially attractive, because it results in a large capacity gain independent of the radio channel.

What makes such enhancements attractive is that the networks do not require any changes other than increased capacity within the infrastructure to support the higher bandwidth. Moreover, the network can support a combination of devices, including both earlier devices that do not include these enhancements and later devices that do. Device vendors can selectively apply these enhancements to their higher performing devices.

MIMO

Another standardized capability is MIMO, a technique that employs multiple transmit antennas and multiple receive antennas, often in combination with multiple radios and multiple parallel data streams. The most common use of the term “MIMO” applies to spatial multiplexing. The transmitter sends different data streams over each antenna. Whereas multipath is an impediment for other radio systems, MIMO—as illustrated in Figure 31—actually exploits multipath, relying on signals to travel across different uncorrelated communications paths. This results in multiple data paths effectively operating somewhat in parallel and, through appropriate decoding, in a multiplicative gain in throughput.

Figure 31: MIMO Using Multiple Paths to Boost Throughput and Capacity

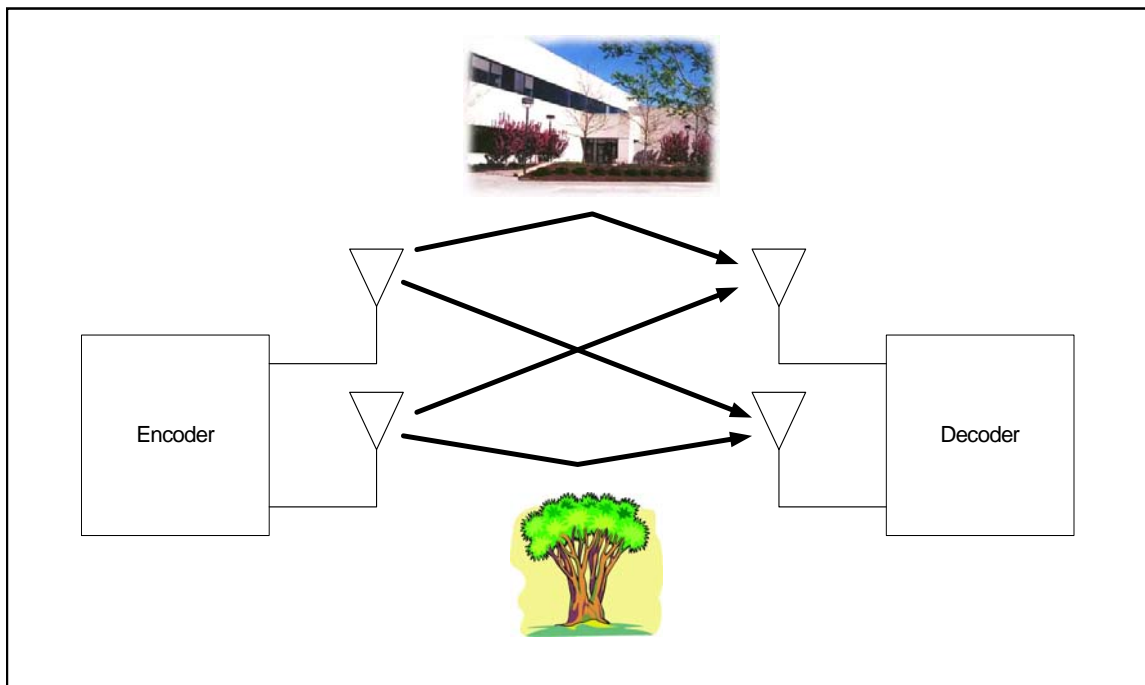

Tests of MIMO have proven very promising in WLANs operating in relative isolation where interference is not a dominant factor. Spatial multiplexing MIMO should also benefit HSPA “hotspots” serving local areas such as airports, campuses, and malls, where the technology will increase capacity and peak data rates. In a fully loaded network with interference from adjacent cells, however, overall capacity gains will be more modest—in the range of 20 to 33 percent over mobile-receive diversity. Relative to a 1x1 antenna system, however, 2X2 MIMO can deliver cell throughput gains of about 80 percent. 3GPP has standardized spatial multiplexing MIMO in Release 7 using Double Transmit Adaptive Array (D-TxAA).⁹⁶

⁹⁶ For further details on these techniques, refer to the 3G Americas white paper “Mobile Broadband: The Global Evolution of UMTS/HSPA. 3GPP Release 7 and Beyond.”

Although MIMO can significantly improve peak rates, other techniques such as Space Division Multiple Access (SDMA)—also a form of MIMO—may be even more effective than MIMO for improving capacity in high spectral efficiency systems employing a reuse factor of 1.

Continuous Packet Connectivity

In Release 7, CPC enhancements reduce the uplink interference created by the dedicated physical control channels of packet data users when those channels have no user data to transmit. This, in turn, increases the number of simultaneously connected HSUPA users. CPC allows both discontinuous uplink transmission and discontinuous downlink reception, where the modem can turn off its receiver after a certain period of HSDPA inactivity. CPC is especially beneficial to VoIP on the uplink, which consumes the most power, because the radio can turn off between VoIP packets. See Figure 32.

Figure 32: Continuous Packet Connectivity

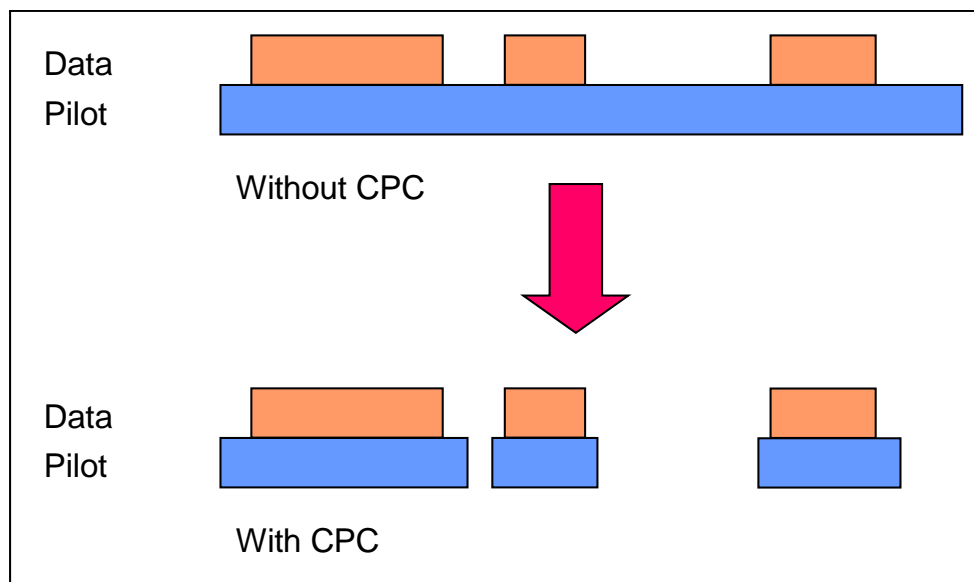

Higher Order Modulation

Another way of increasing performance is to use higher order modulation. HSPA uses 16 QAM on the downlink and QPSK on the uplink. But radio links can achieve higher throughputs—adding 64 QAM on the downlink and 16 QAM on the uplink—precisely what is added in HSPA+. Higher order modulation requires a better SNR, which is enabled through other enhancements such as receive diversity and equalization.

HSPA+

Taking advantage of these various radio technologies, 3GPP has standardized a number of features in Release 7 including higher order modulation and MIMO. Collectively, these capabilities are referred to as HSPA+. Release 8 will include further enhancements.

The goals of HSPA+ are to:

- ❑ Exploit the full potential of a CDMA approach before moving to an OFDM platform in 3GPP LTE.
- ❑ Achieve performance close to LTE in 5 MHz of spectrum.

- ❑ Provide smooth interworking between HSPA+ and LTE, thereby facilitating the operation of both technologies. As such, operators may choose to leverage the EPC/SAE planned for LTE.
- ❑ Allow operation in a packet-only mode for both voice and data.
- ❑ Be backward-compatible with previous systems while incurring no performance degradation with either earlier or newer devices.
- ❑ Facilitate migration from current HSPA infrastructure to HSPA+ infrastructure.

Depending on the features implemented, HSPA+ can exceed the capabilities of IEEE 802.16e-2005 (mobile WiMAX) in the same amount of spectrum. This is mainly because HSPA MIMO supports closed-loop operation with precoding, as well as multicarrier MIMO, and enables the use of SIC receivers. It is also partly because HSPA supports Incremental Redundancy (IR) and has lower overhead than WiMAX.

Table 15 summarizes the capabilities of HSPA and HSPA+ based on various methods.

Table 15: HSPA Throughput Evolution

Technology	Downlink (Mbps) Peak Data Rate	Uplink (Mbps) Peak Data Rate
HSPA as defined in Release 6	14.4	5.76
Release 7 HSPA+ DL 64 QAM, UL 16 QAM	21.1	11.5
Release 7 HSPA+ 2X2 MIMO, DL 16 QAM, UL 16 QAM	28.0	11.5
Release 8 HSPA+ 2X2 MIMO DL 64 QAM, UL 16 QAM	42.2	11.5
HSPA+ 2X2 MIMO, Dual Carrier (anticipated in Release 9)	84	11.5

Beyond the peak rate of 42 Mbps defined in Release 8, Release 9 may specify 2X2 MIMO in combination with dual carrier operation which would further boost peak network rates to 84 Mbps.

HSPA+ will also have improved latency performance of below 50 msec, and improved packet call setup time of below 500 msec.

HSPA+ with 28 Mbps capability will be available for deployment by the end of 2009, and HSPA+ with 42 Mbps capability on the downlink and 11.5 Mbps on the uplink could be ready for deployment by 2009 or 2010.

Given the large amount of backhaul bandwidth required to support HSPA+, as well as additional MIMO radios at cell sites, operators are likely to initially deploy HSPA+ in limited "hotspot" coverage areas such as airports, enterprise campuses, and in-building networks. With advances in backhaul transport like metropolitan Ethernet, however, operators will be able to expand coverage.

The prior discussion emphasizes throughput speeds, but HSPA+ will also more than double HSPA capacity as well as reduce latency below 25 msec. Sleep-to-data-transfer

times of less than 200 msec will improve users' "always-connected" experience, and reduced power consumption with VoIP will result in talk times that are more than 50 percent higher.

From a deployment point of view, operators will be able to introduce HSPA+ capabilities through either a software upgrade or hardware expansions to existing cabinets to increase capacity. Certain upgrades will be simpler than others. For example, upgrading to 64-QAM support will be easier to implement than 2X2 MIMO for many networks. For networks that have implemented uplink diversity in the base station, however, those multiple antennas will facilitate MIMO deployment.

Dual-Carrier HSPA

3GPP has defined a work item for Release 8 to investigate dual-carrier HSPA operation. This approach coordinates the operation of HSPA on two adjacent 5 MHz carriers so that data transmissions can achieve higher throughput rates. The work item assumes two adjacent carriers, downlink operation and no MIMO. In this configuration, it will be possible to achieve a doubling of the 21 Mbps maximum rate available on each channel to 42 Mbps.

Although there is no increase in overall spectral efficiency, there are benefits:

- ❑ Significantly higher peak throughputs available to users, especially in lightly-loaded networks.
- ❑ Same maximum-throughput rate of 42 Mbps as using MIMO, but with a less expensive infrastructure upgrade.

The following figure shows an analysis of dual-carrier performance using a cumulative distribution function. CDF indicates the probability of achieving a particular throughput rate and the figure demonstrates a consistent doubling of throughput.

Figure 33: Dual-Carrier Performance⁹⁷

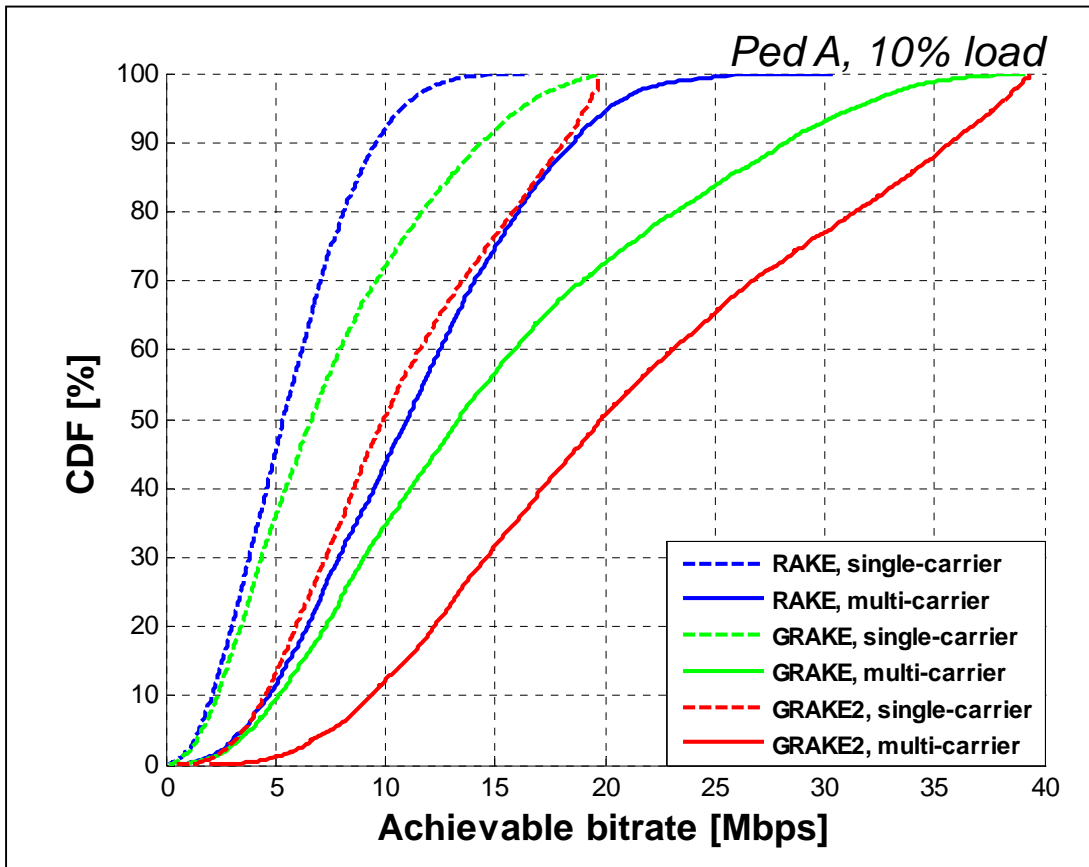

One-Tunnel Architecture

Another way HSPA performance can be improved is through a flatter architecture. In Release 7, there is the option of a one-tunnel architecture by which the network establishes a direct transfer path for user data between RNC and GGSN while the SGSN still performs all control functions. This brings several benefits such as eliminating hardware in the SGSN and simplified engineering of the network.

There is also an integrated RNC/NodeB option in which RNC functions are integrated in the Node B. This is particularly beneficial in femto cell deployments, as an RNC would otherwise need to support thousands of femtocells. The integrated RNC/NodeB for HSPA+ has been agreed-upon as an optional architecture alternative for packet-switched-based services.

These new architectures, as shown in Figure 34, are similar to the EPC/SAE architecture, especially on the packet-switched core network side where they provide synergies with the introduction of LTE.

⁹⁷ Source: 3G Americas member company contribution.

Figure 34: HSPA One-Tunnel Architecture⁹⁸

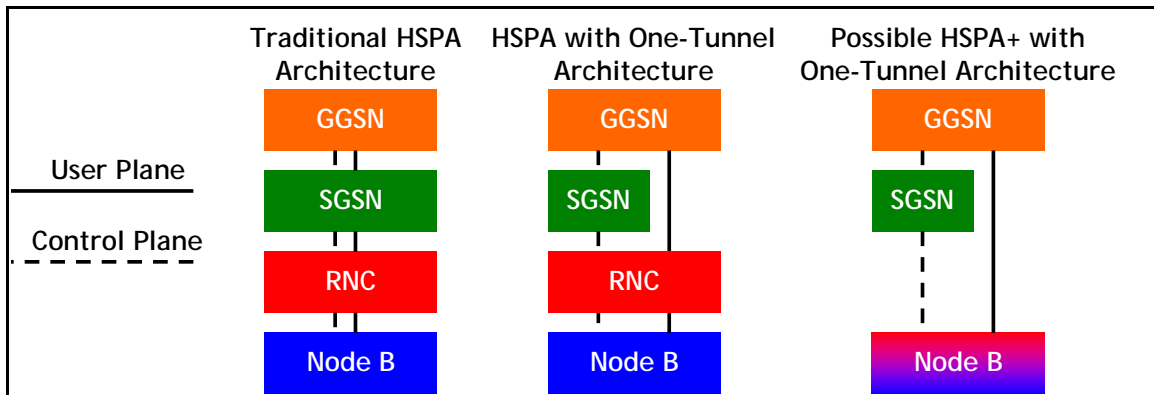

HSPA, HSPA+, and other advanced functions provide a compelling advantage for UMTS over competing technologies: The ability today to support voice and data services on the same carrier and across the whole available radio spectrum; to offer these services simultaneously to users; to deliver data at ever-increasing broadband rates; and to do so in a spectrally efficient manner.

HSPA Voice Support

Voice support with WCDMA dedicated channels in UMTS networks is spectrally very efficient. Moreover, current networks support simultaneous voice and data operation. There are, however, reasons to consider alternate approaches including reducing power consumption and being able to support even more users. One approach is called circuit-switched voice over HSPA. The other is VoIP.

CS Voice over HSPA

HSPA channels employ many optimizations to obtain a high degree of data throughput, which is why it makes sense to use them to carry voice communications. Doing so with VoIP, however, requires not only supporting packetized voice in the radio channel, but also within the infrastructure network. There is an elegant alternative: To packetize the circuit-switched voice traffic which is already in digital form, use the HSPA channels to carry the CS voice, but then to connect the CS voice traffic back into the existing CS infrastructure (MSCs, etc.) immediately beyond the radio access network. This requires relatively straightforward changes in just the radio network and in devices. The following figure shows the infrastructure changes required at the Node B and within the RNC.

⁹⁸ Source: 3G Americas white paper, 2007, "UMTS Evolution from 3GPP Release 7 to Release 8."

Figure 35: Implementation of HSPA CS Voice⁹⁹

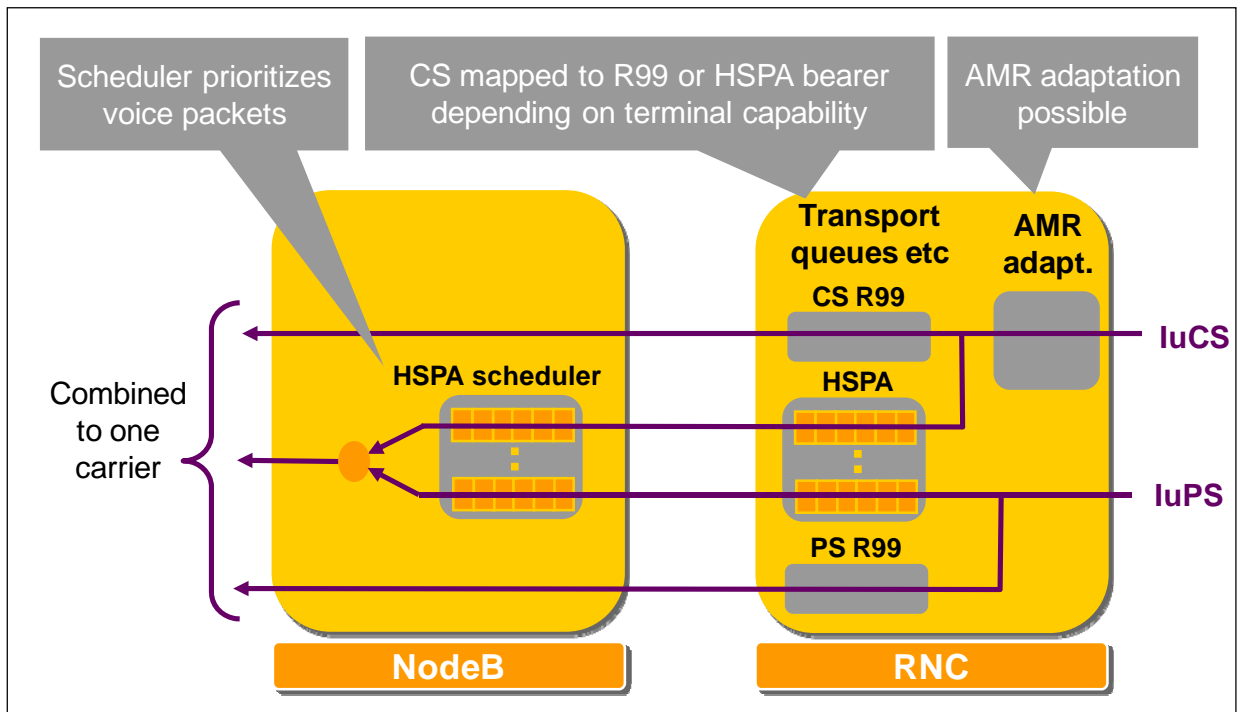

With this approach, legacy mobile phones can continue using WCDMA-dedicated traffic channels for voice communications while new devices use HSPA channels. HSPA CS voice can be deployed with Release 7 or later networks.

The many benefits of this approach, listed below, make it highly likely that operators will adopt it:

- ❑ Relatively easy to implement and deploy.
- ❑ Transparent to existing CS infrastructure.
- ❑ Supports both narrowband and wideband codecs.
- ❑ Significantly improves battery life with voice communications.
- ❑ Enables faster call connections.
- ❑ Provides a 50 to 100% capacity gain over current voice implementations.
- ❑ Acts as a stepping stone to VoIP over HSPA/LTE in the future.

VoIP

Once HSDPA and HSUPA are available, operators will have another option of moving voice traffic over to these high-speed data channels, which is using VoIP. This will eventually increase voice capacity, allow operators to consolidate their infrastructure on an IP platform, and enable innovative new applications that combine voice with data functions in the packet domain. VoIP is possible in Release 6, but it is enhancements in

⁹⁹ Source: 3G Americas white paper, 2007, "UMTS Evolution from 3GPP Release 7 to Release 8."

Release 7 that make it highly efficient and thus attractive to network operators. VoIP will be implemented in conjunction with IMS, discussed later in this paper.

One attractive aspect of deploying VoIP with HSPA is that operators can smoothly migrate users from circuit-switched operation to packet-switched operation over time. Because the UMTS radio channel supports both circuit-switched voice and packet-switched data, some voice users can be on legacy circuit-switched voice and others can be on VoIP. Figure 36 shows a system's voice capacity with the joint operation of circuit-switched and IP-based voice services.

Figure 36: Ability for UMTS to Support Circuit and Packet Voice Users¹⁰⁰

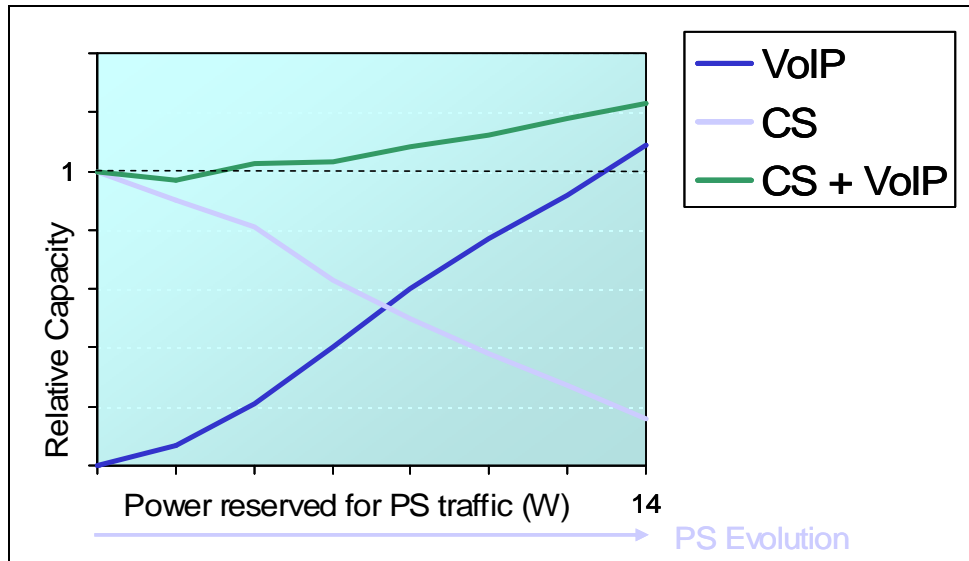

VoIP capacity gains are quantified in detail in the main part of in this paper. They range from 20 percent to as high as 100 percent with the implementation of interference cancellation and the minimization of IP overhead through a scheme called Robust Header Compression (ROHC).

Whereas packet voice is the only way voice will be supported in LTE, with HSPA+, it may not be used immediately for primary voice services. This is because UMTS already has a highly efficient circuit-switched voice service and already allows simultaneous voice/data operation. Moreover, packet voice requires a considerable amount of new infrastructure in the core network. As a result, packet voice will likely be used initially as part of other services (for example, those based on IMS), and only over time will it transition to primary voice service.

3GPP LTE

Although HSPA and HSPA+ offer a highly efficient broadband-wireless service that will enjoy success for the remainder of this decade and well into the next, 3GPP is working on a project called Long Term Evolution as part of Release 8. LTE will allow operators to achieve even higher peak throughputs in higher spectrum bandwidth. Work on LTE

¹⁰⁰ Source: 3G Americas member contribution.

began in 2004 with an official work item started in 2006 and a completed specification expected in early 2009. Initial possible deployment is targeted for 2010.

LTE uses OFDMA on the downlink, which is well suited to achieve high peak data rates in high-spectrum bandwidth. WCDMA radio technology is basically as efficient as OFDM for delivering peak data rates of about 10 Mbps in 5 MHz of bandwidth. Achieving peak rates in the 100 Mbps range with wider radio channels, however, would result in highly complex terminals, and it is not practical with current technology. This is where OFDM provides a practical implementation advantage. Scheduling approaches in the frequency domain can also minimize interference, thereby boosting spectral efficiency. The OFDMA approach is also highly flexible in channelization, and LTE will operate in various radio channel sizes ranging from 1.25 to 20 MHz.

On the uplink, however, a pure OFDMA approach results in high Peak to Average Ratio (PAR) of the signal, which compromises power efficiency and, ultimately, battery life. Hence, LTE uses an approach called SC-FDMA, which is somewhat similar to OFDMA, but has a 2 to 6 dB PAR advantage over the OFDMA method used by other technologies such as IEEE 802.16e.

LTE capabilities include:

- ❑ Downlink peak data rates up to 326 Mbps with 20 MHz bandwidth.
- ❑ Uplink peak data rates up to 86.4 Mbps with 20 MHz bandwidth.
- ❑ Operation in both TDD and FDD modes.
- ❑ Scalable bandwidth up to 20 MHz, covering 1.4, 3, 5, 10, 15, and 20 MHz in the study phase.
- ❑ Increased spectral efficiency over Release 6 HSPA by a factor of two to four.
- ❑ Reduced latency, to 10 msec round-trip times between user equipment and the base station, and to less than 100 msec transition times from inactive to active.

The overall objective is to provide an extremely high performance, radio-access technology that offers full vehicular speed mobility and that can readily coexist with HSPA and earlier networks. Because of scalable bandwidth, operators will be able to easily migrate their networks and users from HSPA to LTE over time.

Table 16 shows LTE peak data rates based on different downlink and uplink designs.

Table 16: LTE Peak Throughput Rates

LTE Configuration	Downlink (Mbps) Peak Data Rate	Uplink (Mbps) Peak Data Rate
Using 2X2 MIMO in the Downlink and 16 QAM in the Uplink	172.8	57.6
Using 4X4 MIMO in the Downlink and 64 QAM in the Uplink	326.4	86.4

LTE is not only efficient for data but, because of a highly efficient uplink, is extremely efficient for VoIP traffic. In 10 MHz of spectrum, LTE VoIP capacity will reach almost 500 users.¹⁰¹

LTE implements OFDM in the downlink. The basic principle of OFDM is to split a high-rate data stream into a number of parallel low-rate data streams, each a narrowband signal carried by a subcarrier. The different narrowband streams are generated in the frequency domain, and then combined to form the broadband stream using a mathematical algorithm called an Inverse Fast Fourier Transform (IFFT) that is implemented in digital-signal processors. In LTE, the subcarriers have 15 kHz spacing from each other. LTE maintains this spacing regardless of the overall channel bandwidth, which simplifies radio design, especially in supporting radio channels of different widths. The number of subcarriers ranges from 72 in a 1.4 MHz channel to 1,200 in a 20 MHz channel.

The composite signal is obtained after the IFFT is extended by repeating the initial part of the signal (called the Cyclic Prefix [CP]). This extended signal represents an OFDM symbol. The CP is basically a guard time during which reflected signals will reach the receiver. It results in an almost complete elimination of multipath induced Intersymbol Interference (ISI), which otherwise makes extremely high data rate transmissions problematic. The system is called orthogonal, because the subcarriers are generated in the frequency domain (making them inherently orthogonal), and the IFFT conserves that characteristic. OFDM systems may lose their orthogonal nature as a result of the Doppler shift induced by the speed of the transmitter or the receiver. 3GPP specifically selected the subcarrier spacing of 15 kHz to avoid any performance degradation in high-speed conditions. WiMAX systems that use a lower subcarrier spacing (~11 kHz) will be more impacted in high-speed conditions than LTE.

Figure 37: OFDM Symbol with Cyclic Prefix

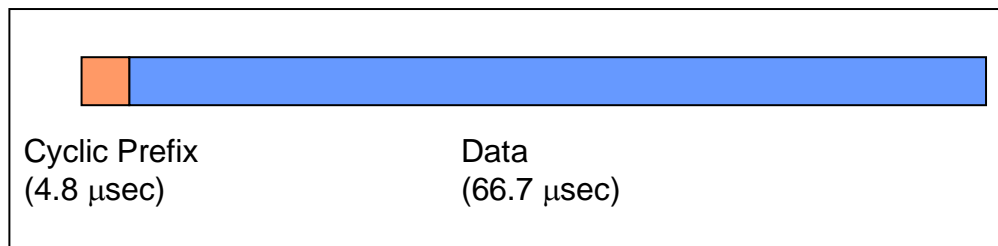

The multiple-access aspect of OFDMA comes from being able to assign different users different subcarriers over time. A minimum resource block that the system can assign to a user transmission consists of 12 subcarriers over 14 symbols in 1.0 msec. Figure 38 shows how the system can assign these resource blocks to different users over both time and frequency.

¹⁰¹ Source: 3GPP Multi-member analysis.

Figure 38: LTE OFDMA Downlink Resource Assignment in Time and Frequency

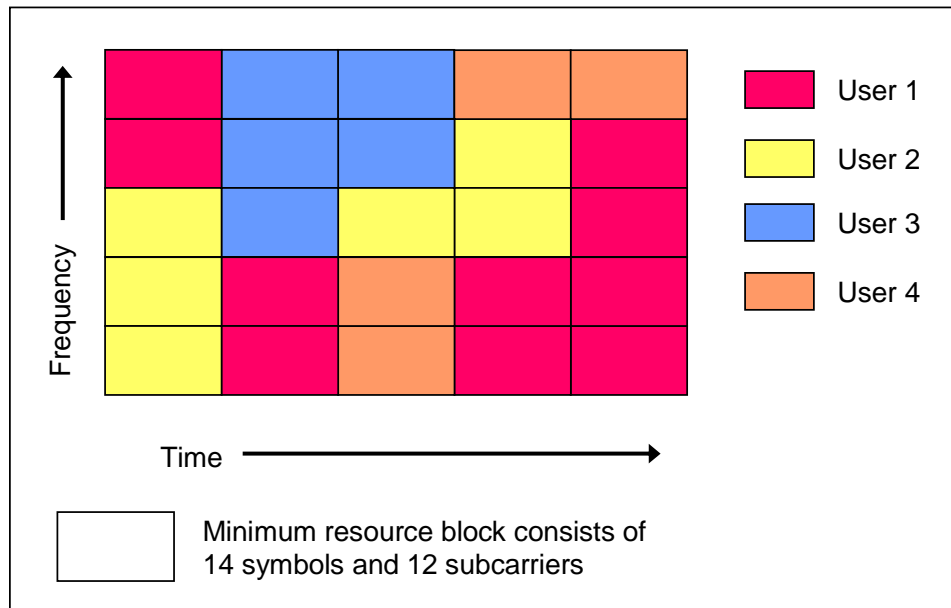

By having control over which subcarriers are assigned in which sectors, LTE can easily control frequency reuse. By using all the subcarriers in each sector, the system would operate at a frequency reuse of 1; but by using a different one third of the subcarriers in each sector, the system achieves a looser frequency reuse of 1/3. The looser frequency reduces overall spectral efficiency, but delivers high peak rates to users.

LTE is specified for a variety of MIMO configurations. On the downlink, these include 2X2, 4X2 (four antennas at the base station), and 4X4. Initial deployment will likely be 2x2. 4X4 will be most likely used initially in femto cells. On the uplink, there are two possible approaches: single user MIMO (SU-MIMO) and multi-user MIMO (MU-MIMO). SU-MIMO is more complex to implement as it requires two parallel radio transmit chains in the mobile device, whereas MU-MIMO does not require any additional implementation at the device. The first LTE release thus incorporates MU-MIMO with SU-MIMO deferred for the second LTE release.

4G, IMT-Advanced and LTE Advanced

LTE will address the market needs of the next decade. After that, operators may deploy Fourth Generation (4G) networks using LTE technology as a foundation. Currently, there are no official standards or formal definitions for 4G. Preliminary research is focused on technologies capable of delivering peak rates of 1 gigabit per second (Gbps) in hotspot-type scenarios and 100 Mbps while mobile, being fully IP-based, and supporting full network agility for handovers between different types of networks (for example, 4G to 3G to WLAN). The high data rates will require radio channels wider than 20MHz, most likely in new spectrum, as discussed above in the section "Spectrum."

Some companies are attempting to co-opt the term "4G" to refer to wireless systems that promise performance beyond current 3G systems. All of these systems are on par with HSPA/HSPA+ and LTE, however, and use of the term "4G" for them is inappropriate. ITU is the internationally recognized organization producing the official definition of next-generation wireless technologies. Through its Radio Communications

Sector (ITU-R), ITU is currently working on a definition of 4G using the name IMT-Advanced. Current 3G systems came about through ITU's prior project on International Mobile Telecommunications 2000 (IMT-2000).

As background for this project, ITU published a document, Recommendation ITU-R M.1645, titled "Framework and overall objectives of the future development of IMT-2000 and systems beyond IMT-2000."

The IMT-Advanced project schedule shows the requirements and evaluation criteria being published in 2008 with submissions to occur through 2009. 3GPP will address the requirements in a version of LTE called LTE Advanced for which specifications could become available in 2011. 3GPP will specify LTE Advanced in Release 10. WiMAX will address the IMT-Advanced requirements in a version called Mobile WiMAX 2.0, to be specified in IEEE 802.16m.

No details are available yet on these advanced technologies, but ideas under consideration include:

- ❑ Evolution of current OFDMA approaches.
- ❑ High-order MIMO (e.g., 4X4).
- ❑ Wider radio channels (e.g., 50 to 100 MHz).
- ❑ Optimization in narrower bands (e.g., less than 20 MHz) due to spectrum constraints in some deployments.
- ❑ Multi-channel operation in either same or different frequency bands.
- ❑ Ability to share bands with other services.

Globally, there are a variety of wireless research and development projects, initiatives, and organizations that are advancing the capabilities of wireless systems. These include the Wireless World Research Forum, Wireless World Initiatives, Information and Communication Technologies (ICT), research under the European Union's Seventh Framework Programme (FP7), Japan Mobile IT Forum (mITF), the Electronic and Telecommunications Research Institute (ETRI) in Korea, and the Next Generation Mobile Committee (NGMC).

Given this paper's projection of mid-next-decade before OFDMA-based systems like LTE have a large percentage of subscribers, it could be well toward the end of the next decade before any IMT-Advanced system has a large subscriber base. Needless to say, vendors will be looking at how to leverage and enhance current OFDMA systems like LTE, UMB, and WiMAX to meet the requirements of IMT-Advanced.

UMTS TDD

Most WCDMA and HSDPA deployments are based on FDD, in which the operator uses different radio bands for transmit and receive. An alternate approach is TDD, in which both transmit and receive functions alternate in time on the same radio channel. 3GPP specifications include a TDD version of UMTS, called UMTS TDD.

TDD does not provide any inherent advantage for voice functions, which need balanced links—namely, the same amount of capacity in both the uplink and the downlink. Many data applications, however, are asymmetric, often with the downlink consuming more bandwidth than the uplink, especially for applications like Web browsing or multimedia downloads. A TDD radio interface can dynamically adjust the downlink-to-uplink ratio accordingly, hence balancing both forward-link and reverse-link capacity. Note that for

UMTS FDD, the higher spectral efficiency achievable in the downlink versus the uplink is critical in addressing the asymmetrical nature of most data traffic.

The UMTS TDD specification also includes the capability to use joint detection in receiver-signal processing, which offers improved performance. The vendor IP Wireless, acquired by NextWave in May 2007, had commercialized UMTS TDD.

One consideration, however, relates to available spectrum. Various countries around the world including Europe, Asia, and the Pacific region have licensed spectrum available specifically for TDD systems. For this spectrum, UMTS TDD, or in the future LTE in TDD mode, is a good choice. It is also a good choice in any spectrum that does not provide a duplex gap between forward and reverse links.

In the United States, there is limited spectrum specifically allocated for TDD systems.¹⁰² UMTS TDD is not a good choice in FDD bands; it would not be able to operate effectively in both bands, thereby making the overall system efficiency relatively poor.

As discussed in more detail in the "WiMAX" section, TDD systems require network synchronization and careful coordination between operators or guard bands, which may be problematic in certain bands.

There has been little deployment of UMTS TDD. Future TDD deployments of 3GPP technologies are likely to be based on LTE.

TD-SCDMA

TD-SCDMA is one of the official 3G wireless technologies being developed, mostly for deployment in China. Specified through 3GPP as a variant of the UMTS TDD System and operating with a 1.28 Megachips per second (Mcps) chip rate against 3.84 Mcps for UMTS TDD, the primary attribute of TD-SCDMA is that it is designed to support very high subscriber densities. This makes it a possible alternative for wireless local loops. TD-SCDMA uses the same core network as UMTS, and it is possible for the same core network to support both UMTS and TD-SCDMA radio-access networks.

TD-SCDMA technology is not as mature as UMTS and CDMA2000, with 2008 being the first year of limited deployments in China in time for the Olympic Games. Though there are no planned deployments in any country other than China, TD-SCDMA could theoretically be deployed anywhere unpaired spectrum is available—such as the bands licensed for UMTS TDD—assuming appropriate resolution of regulatory issues.

IMS

IMS is a service platform that allows operators to support IP multimedia applications. Potential applications include video sharing, PoC, VoIP, streaming video, interactive gaming, and so forth. IMS by itself does not provide all these applications. Rather, it provides a framework of application servers, subscriber databases, and gateways to make them possible. The exact services will depend on cellular operators and application developers that make these applications available to operators.

The core networking protocol used within IMS is Session Initiation Protocol (SIP), which includes the companion Session Description Protocol (SDP) used to convey configuration information such as supported voice codecs. Other protocols include Real Time Transport Protocol (RTP) and Real Time Streaming Protocol (RTSP) for transporting actual

¹⁰² The 1910-1920 MHz band targeted unlicensed TDD systems, but has never been used.

sessions. The QoS mechanisms in UMTS will be an important component of some IMS applications.

Although originally specified by 3GPP, numerous other organizations around the world are supporting IMS. These include the Internet Engineering Taskforce (IETF), which specifies key protocols such as SIP, and the Open Mobile Alliance, which specifies end-to-end service-layer applications. Other organizations supporting IMS include the GSM Association (GSMA), the ETSI, CableLabs, 3GPP2, The Parlay Group, the ITU, the American National Standards Institute (ANSI), the Telecoms and Internet Converged Services and Protocols for Advanced Networks (TISPAN), and the Java Community Process (JCP).

IMS is relatively independent of the radio-access network and can, and likely will, be used by other radio-access networks or wireline networks. Operators are already trialing IMS, and one initial application under consideration—PoC—is being specified by the Open Mobile Alliance. Other applications include picture and video sharing that occur in parallel with voice communications. Operators looking to roll out VoIP over networks could also use IMS. 3GPP initially introduced IMS in Release 5 and has enhanced it in each subsequent specification release.

As shown in Figure 39, IMS operates just outside the packet core.

Figure 39: IP Multimedia Subsystem

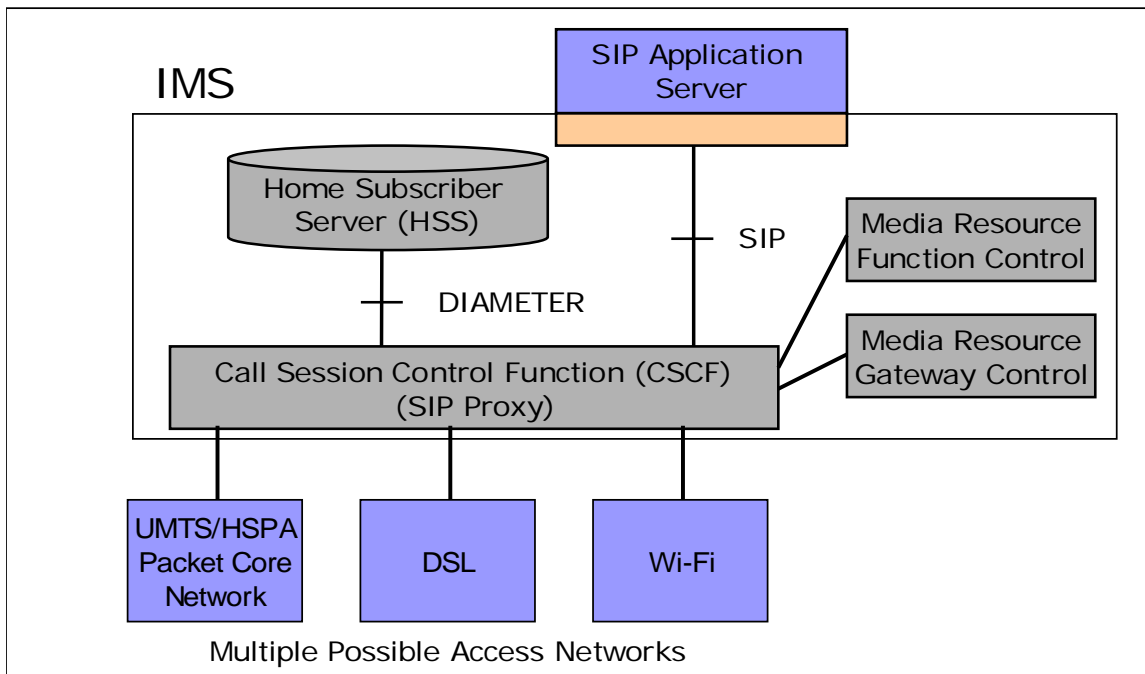

The benefits of using IMS include handling all communication in the packet domain, tighter integration with the Internet, and a lower cost infrastructure that is based on IP building blocks used for both voice and data services. This allows operators to potentially deliver data and voice services at lower cost, thus providing these services at lower prices and further driving demand and usage.

IMS applications can reside either in the operator's network or in third-party networks including enterprises. By managing services and applications centrally—and independently of the access network—IMS can enable network convergence. This allows operators to offer common services across 3G, Wi-Fi, and wireline networks.

Broadcast/Multicast Services

An important capability for 3G and evolved 3G systems is broadcasting and multicasting, wherein multiple users receive the same information using the same radio resource. This creates a much more efficient approach for delivering content such as video programming to which multiple users have subscriptions. In a broadcast, every subscriber unit in a service area receives the information, whereas in a multicast, only users with subscriptions receive the information. Service areas for both broadcast and multicast can span either the entire network or a specific geographical area. Because multiple users in a cell are tuned to the same content, broadcasting and multicasting result in much greater spectrum efficiency for services such as mobile TV.

3GPP defined highly-efficient broadcast/multicast capabilities for UMTS in Release 6 with MBMS. Release 7 includes optimizations through a solution called multicast/broadcast single-frequency network operation which involves simultaneous transmission of the exact waveform across multiple cells. This enables the receiver to constructively superpose multiple MBSFN cell transmissions. The result is highly efficient WCDMA-based broadcast transmission technology that matches the benefits of OFDMA-based broadcast approaches.

LTE will also have a broadcast/multicast capability. OFDM is particularly well-suited for broadcasting, because the mobile system can combine the signal from multiple base stations and because of the narrowband nature of OFDM. Normally, these signals would interfere with each other. As such, the LTE broadcast capability is expected to be quite efficient.

Figure 40: OFDM Enables Efficient Broadcasting

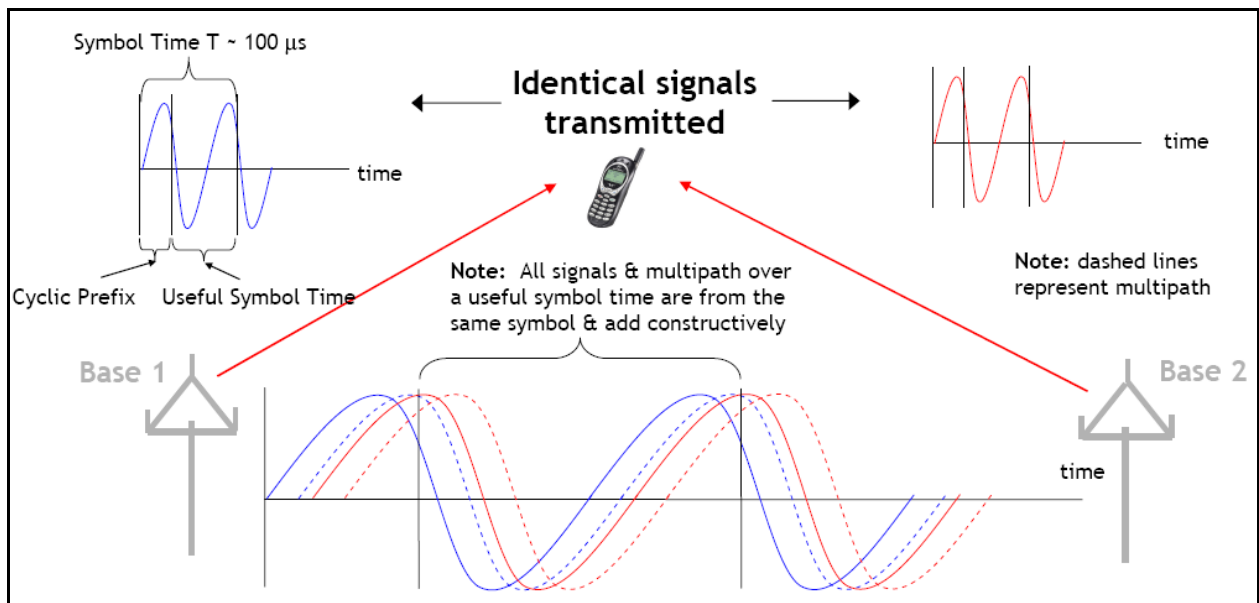

An alternate approach for mobile TV is to use an entirely separate broadcast network with technologies such as Digital Video Broadcasting–Handheld (DVB-H) or Media Forward Link Only (MediaFLO), which various operators around the world have opted to do. Though this requires a separate radio in the mobile device, the networks are highly optimized for broadcast.

EPC/SAE

3GPP is defining EPC/SAE in Release 8 as a framework for an evolution or migration of the 3GPP system to a higher-data-rate, lower-latency, packet-optimized system that supports multiple radio-access technologies. The focus of this work is on the packet-switched domain with the assumption that the system will support all services—including voice—in this domain.

Although it will most likely be deployed in conjunction with LTE, EPC/SAE could also be deployed for use with HSPA+ where it could provide a stepping-stone to LTE. EPC/SAE will be optimized for all services to be delivered via IP in a manner that is as efficient as possible—through minimization of latency within the system, for example. It will support service continuity across heterogeneous networks, which will be important for LTE operators that must simultaneously support GSM /EDGE/UMTS/HSPA customers.

One important performance aspect of EPC/SAE is a flatter architecture. For packet flow, EPC/SAE includes two network elements, called Evolved Node B (eNodeB) and the Access Gateway (AGW). The eNodeB (base station) integrates the functions traditionally performed by the radio-network controller, which previously was a separate node controlling multiple Node Bs. Meanwhile, the AGW integrates the functions traditionally performed by the SGSN and GGSN. The AGW has both control functions, handled through the Mobile Management Entity (MME), and user plane (data communications) functions. The user plane functions consist of two elements: A serving gateway that addresses 3GPP mobility and terminates eNodeB connections, and a Packet Data Network (PDN) gateway that addresses service requirements and also terminates access by non-3GPP networks. The MME, serving gateway, and PDN gateways can be collocated in the same physical node or distributed, based on vendor implementations and deployment scenarios.

The EPC/SAE architecture is similar to the HSPA One-Tunnel Architecture discussed in the “HSPA+” section that allows for easy integration of HSPA networks to the EPC/SAE. Another architectural option is to reverse the topology, so that the EPC/SAE Access Gateway is located close to the RAN in a distributed fashion to reduce latency while the MME is centrally located to minimize complexity and cost.

EPC/SAE also allows integration of non-3GPP networks such as WiMAX. EPC/SAE will use IMS as a component. It will also manage QoS across the whole system, which will be essential for enabling a rich set of multimedia-based services.

Figure 41 shows the EPC/SAE architecture.

Figure 41: EPC/SAE Architecture

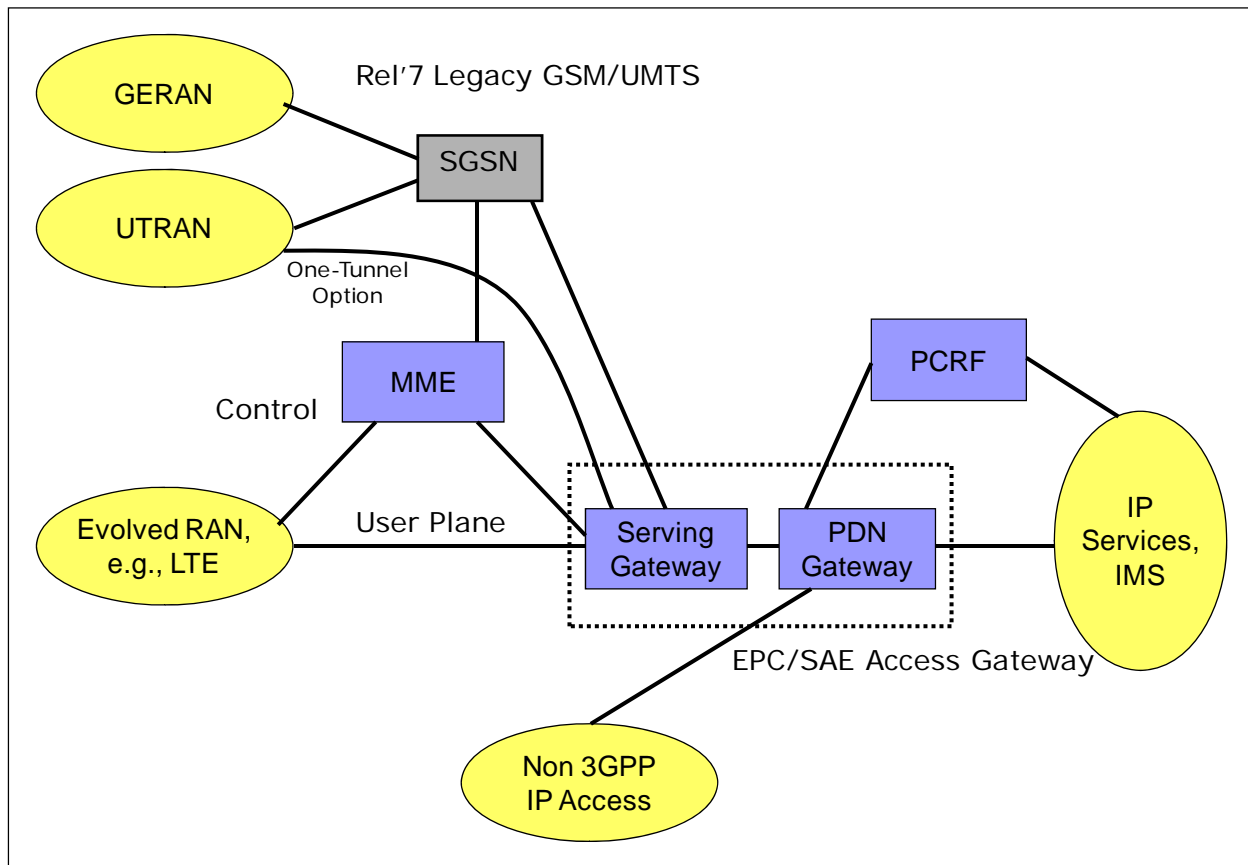

Elements of the SAE architecture include:

- ❑ Support for legacy GERAN and UTRAN networks connected via SGSN.
- ❑ Support for new radio-access networks such as LTE.
- ❑ The Serving Gateway that terminates the interface toward the 3GPP radio-access networks.
- ❑ The PDN gateway that controls IP data services, does routing, allocates IP addresses, enforces policy, and provides access for non-3GPP access networks.
- ❑ The MME that supports user equipment context and identity as well as authenticates and authorizes users.
- ❑ The Policy Control and Charging Rules Function (PCRF) that manages QoS aspects.

Acronyms

The following acronyms are used in this paper. Acronyms are defined on first use.

1xEV-DO – One Carrier Evolved, Data Optimized
1xEV-DV – One Carrier Evolved, Data Voice
1XRTT – One Carrier Radio Transmission Technology
2G – Second Generation
3G – Third Generation
3GPP – Third Generation Partnership Project
3GPP2 – Third Generation Partnership Project 2
4G – Fourth Generation
8-PSK – Octagonal Phase Shift Keying
AAS – Adaptive Antenna Systems
AGW – Access Gateway
AMR – Adaptive Multi Rate
ANSI – American National Standards Institute
ARQ – Automatic Repeat Request
ARPU – Average Revenue Per User
ATM – Asynchronous Transfer Mode
AWGN – Additive White Gaussian Noise Channel
BCCH – Broadcast Control Channel
bps – bits per second
BRS – Broadband Radio Service
BSC – Base Station Controller
BTS – Base Transceiving Station
C/I – Carrier to Interference Ratio
CAPEX- Capital Expenditure
CDF – Cumulative Distribution Function
CDMA – Code Division Multiple Access
CMOS – Complementary Metal Oxide Semiconductor
CP – Cyclic Prefix
CPC – Continuous Packet Connectivity
CRM – Customer Relationship Management
DAS – Downlink “A” Level Scheme
dB – Decibel
DBS – Downlink “B” Level Scheme
DC-HSPA – Dual Carrier HSPA
DSL – Digital Subscriber Line

DTM – Dual Transfer Mode
D-TxAA – Double Transmit Adaptive Array
DVB-H – Digital Video Broadcasting Handheld
E-DCH – Enhanced Dedicated Channel
EBCMCS – Enhanced Broadcast Multicast Services
EDGE – Enhanced Data Rates for GSM Evolution
EGPRS – Enhanced General Packet Radio Service
eNodeB – Evolved Node B
EPS – Evolved Packet System
ERP – Enterprise Resource Planning
ETRI – Electronic and Telecommunications Research Institute
ETSI – European Telecommunications Institute
E-UTRAN – Enhanced UMTS Terrestrial Radio Access Network
EV-DO – One Carrier Evolved, Data Optimized
EV-DV – One Carrier Evolved, Data Voice
EVRC – Enhanced Variable Rate Codec
FCC – Federal Communications Commission
FDD – Frequency Division Duplex
Flash OFDM – Fast Low-Latency Access with Seamless Handoff OFDM
FLO – Forward Link Only
FMC – Fixed Mobile Convergence
FP7 – Seventh Framework Programme
FTP – File Transfer Protocol
G-Rake – Generalized Rake Receiver
Gbps – Gigabits Per Second
GERAN – GSM EDGE Radio Access Network
GGSN – Gateway GPRS Support Node
GHz – Gigahertz
GMSK – Gaussian Minimum Shift Keying
GPRS – General Packet Radio Service
GSM – Global System for Mobile communications
GSMA – GSM Association
HARQ – Hybrid Automatic Repeat Request
HD – High Definition
HLR – Home Location Register
HSDPA – High Speed Downlink Packet Access
HS-PDSCH - High Speed Physical Downlink Shared Channels
HSPA – High Speed Packet Access (HSDPA with HSUPA)
HSPA+ – HSPA Evolution
HSUPA – High Speed Uplink Packet Access

Hz – Hertz
ICT – Information and Communication Technologies
IEEE – Institute of Electrical and Electronic Engineers
IETF – Internet Engineering Taskforce
IFFT – Inverse Fast Fourier Transform
IM – Instant Messaging
IMS – IP Multimedia Subsystem
IMT – International Mobile Telecommunications
IPR - Intellectual Property Rights
IP – Internet Protocol
IPTV – Internet Protocol Television
IR – Incremental Redundancy
ISI – Intersymbol Interference
ISP – Internet Service Provider
ITU – International Telecommunications Union
JCP – Java Community Process
kbps – Kilobits Per Second
kHz – Kilohertz
km – Kilometer
LSTI – LTE/SAE Trial Initiative
MAC – Medium Access Control
MBMS - Multimedia Broadcast/Multicast Service
Mbps – Megabits Per Second
Mcps – Megachips Per Second
MCS – Modulation and Coding Scheme
MediaFLO – Media Forward Link Only
MHz – Megahertz
MIMO – Multiple Input Multiple Output
mITF – Japan Mobile IT Forum
MMDS – Multichannel Multipoint Distribution Service
MME – Mobile Management Entity
MMSE – Minimum Mean Square Error
MRxD – Mobile Receive Diversity
MSC – Mobile Switching Center
MU-MIMO – Multi-User MIMO
msec – millisecond
NGMC – Next Generation Mobile Committee
OFDM – Orthogonal Frequency Division Multiplexing
OFDMA – Orthogonal Frequency Division Multiple Access
PAR – Peak to Average Ratio

PBCCH – Packet Broadcast Control Channel
PCRF – Policy Control and Charging Rules Function
PCS – Personal Communications Service
PHY – Physical Layer
PDN – Packet Data Network
PoC – Push-to-talk over Cellular
QAM – Quadrature Amplitude Modulation
QoS – Quality of Service
QPSK – Quadrature Phase Shift Keying
RAB – Radio Access Bearer
RAN – Radio Access Network
RF – Radio Frequency
RNC – Radio Network Controller
ROHC – Robust Header Compression
RTP – Real Time Transport Protocol
RTSP – Real Time Streaming Protocol
SC-FDMA – Single Carrier Frequency Division Multiple Access
SAE – System Architecture Evolution
SDMA – Space Division Multiple Access
SDP – Session Description Protocol
SGSN – Serving GPRS Support Node
SIC – Successive Interference Cancellation
SIP – Session Initiation Protocol
SMS – Short Message Service
SNR – Signal to Noise Ratio
SU-MIMO – Single User MIMO
TCH – Traffic Channel
TDD – Time Division Duplex
TDMA – Time Division Multiple Access
TD-SCDMA – Time Division Synchronous Code Division Multiple Access
TD-CDMA – Time Division Code Division Multiple Access
TIA/EIA – Telecommunications Industry Association/Electronics Industry Association
TISPAN – Telecoms and Internet converged Services and Protocols for Advanced Networks
TTI – Transmission Time Interval
UAS – Uplink “A” Level Scheme
UBS – Uplink “B” Level Scheme
UMA – Unlicensed Mobile Access
UMB – Ultra Mobile Broadband
UMTS – Universal Mobile Telecommunications System
 μ s – Microseconds

UTRAN – UMTS Terrestrial Radio Access Network
VDSL – Very High Speed DSL
VoIP – Voice over Internet Protocol
VPN – Virtual Private Network
WAP – Wireless Application Protocol
WCDMA – Wideband CDMA
Wi-Fi – Wireless Fidelity
WiMAX – Worldwide Interoperability for Microwave Access
WLAN – Wireless Local Area Network
WMAN – Wireless Metropolitan Area Network
WRC-07 – World Radiocommunication Conference 2007

Additional Information

3G Americas maintains complete and current lists of market information, including EDGE, UMTS, and HSDPA deployments worldwide, available for free download on its Web site: <http://www.3gamericas.org>.

If there are any questions regarding the download of this information, please call +1 425 372 8922 or e-mail Krissy Gochmour, Public Relations Administrator, at info@3gamericas.org."

References

3G Americas: "Mobile Broadband: The Global Evolution of UMTS/HSPA – 3GPP Release 7 and Beyond," July 2006.

3G Americas: "UMTS Evolution from 3GPP Release 7 to Release 8, HSPA and SAE/LTE", July 2007.

3G Americas: "UMTS Evolution from 3GPP Release 7 to Release 8, HSPA and SAE/LTE", June 2008 Update.

3G Americas: "Global UMTS and HSPA Operator Status", July 11, 2008.

3GPP: LTE Performance Summary, Downlink, Uplink, VoIP. Multi-vendor assessment. 2007.

ABI Research: press release on study "Mobile Business Applications and Services," August 1, 2007.

Alcatel Lucent: "Technology Comparison", June 2008, submission to 3G Americas

Arthur D Little: "HSPA and Mobile WiMAX for Mobile Broadband Wireless Access – An Independent Report Prepared for the GSM Association, March 27, 2007.

AT&T: "Ideas on LTE-Advanced", 3GPP LTE-Advanced Workshop, April 2008.

AT&T: Tom Keathley, "HSPA: Keys to a Successful Broadband Access Strategy", 2008.

Berg Insight: Smartphone Operating Systems, <http://www.berginsight.com/ReportPDF/ProductSheet/BI-SOS-PS.pdf>, July 2007.

CDMA Developer Group: Deployments, <http://www.cdg.org>, July 14, 2008.

Cingular Wireless: "Competitive Technology Outlook," June 2006, submission to 3G Americas.

Cingular Wireless: uplink throughput data, June 2006, submission to 3G Americas.

Dow Jones NY: "3G Retains its Buzz but Potential Remains Unclear," January 27, 2006.

GSA: The Global mobile Suppliers Association, <http://www.gsacom.com>, July 2007.

Ericsson: "The 3G Long-Term Evolution – Radio Interface Concepts and Performance Evaluation," 2006.

Ericsson: "3GPP Improved UE Receiver Requirements," June 2006, submission to 3G Americas.

Ericsson white paper: "Basic Concepts of HSPA", February 2007.

Ericsson: "Cellular Evolution," May 2006, submission to 3G Americas.

Ericsson: "HSPA and WiMAX Performance," July 2007, submission to 3G Americas.

Ericsson: "HSPA Spectrum Efficiency Evolution", June 2008, submission to 3G Americas.

Ericsson: Johan Bergman et al, "HSPA Evolution – Boosting the performance of mobile broadband access", Ericsson Review No. 1, 2008.

Ericsson white paper: "HSPA, the Undisputed Choice for Mobile Broadband," May 2007.

Ericsson white paper: "HSDPA Performance and Evolution", No 3, 2006.

Ericsson: Per Beming et al, "LTE-SAE architecture and performance", Ericsson Review No. 3, 2007.

Ericsson: Erik Dahlman et al, "Key features of the LTE radio interface", Ericsson Review No. 2, 2008.

Ericsson white paper: "Technical Overview and Performance of HSPA and Mobile WiMAX", June 2007.

Ericsson: "Advanced Receivers for WCDMA Terminal Platforms and Base Stations," Ericsson Review No. 2, 2006.

Ericsson: "GSM/EDGE Continued Evolution," Ericsson Review No. 1, 2006.

Ericsson: "HSDPA performance - HSDPA and R99 on Same Carrier," June 2006, submission to 3G Americas.

Ericsson: HSPA voice migration, June 2006, submission to 3G Americas.

Ericsson: "WCDMA vs. CDMA Business View," 2006, submission to 3G Americas.

Ericsson white paper: "WiMAX – Copper in the Air," April 2006.

Fierce Wireless, press release, <http://www.fiercewireless.com/press-releases/led-asia-pacific-suppliers-cellular-modem-industry-will-exceed-200-million-units-2013>, 2008.

Senza Fili Consulting: Press release of June 19, 2007 describing the report "WiMAX: Ambitions and Reality. A detailed market assessment and forecast at the global, regional and country level (2006-2012)".

Gartner Group: "Forecast: Mobile Terminals, Worldwide, 2000-2009 (4Q05 Update)," January 12, 2006.

GSA: HSPA Devices Survey, July 21, 2008

GSM Association: "Mobile phones on the catwalk" by Paul Rasmussen. Wireless Business Review, Spring 2006.

IEEE International Symposium on Personal, Indoor and Mobile Radio Communications: Anders Furuskär et al "The LTE Radio Interface – Key Characteristics and Performance", 2008.

IEEE: Journal on Selected Areas in Communication, Vol 24, No.1, Qi Bi, "An Analysis of VoIP Service Using 1 EV-DO Revision A System", January 2006.

Informa Telecoms & Media, press release, "Mobile data revenue to exceed US\$200 billion in 2007," July 23, 2008

Informa Telecoms & Media: World Cellular Information Service, June/July 2008.

Informa Telecoms & Media: WCIS Forecast, July 2008.

iSuppli Corp.: "Mobile-Phone Premium Content Market to Reach \$40 billion by 2010," www.cellular-news.com/story/16425.php, March 8, 2006.

Lehman Global Equity Research: Paul Wuh, "Global 3G Developments: 3G subs accelerate; more data revenue in '09" May 23, 2008.

Arthur D. Little Limited: "HSPA and mobile WiMax for Mobile Broadband Wireless Access", 27 March 2007.

Lucent: "Technical Comparison," August 2006, submission to 3G Americas.

Nokia: "3GPP vs. 3GPP2 Cellular VoIP Driver Comparison," June 2006, submission to 3G Americas.

Nokia: "HSDPA Performance Measurements with Commercial QPSK (CAT 12) and 16QAM (CAT 6)," June 2006, submission to 3G Americas.

Nokia: "Future Voice Traffic: Primary vs. Secondary?" June 2006, submission to 3G Americas.

Nokia: "VoIP over HSPA with 3GPP Release 7," by Harri Holma, et. al., 2006.

Nokia: "Overview on HSPA+," June 2006, submission to 3G Americas.

Nokia: "HSUPA Simulation Results," May 2006, submission to 3G Americas.

Nokia: "SAE Evolved Architecture," June 2006, submission to 3G Americas.

Nokia: "WCDMA CS vs. HSPA VoIP Capacity Difference," June 2006, submission to 3G Americas.

Nokia Siemens Networks: "LTE Performance," June 2008, submission to 3G Americas.

Nokia Siemens Networks: "Technology Performance Comparison", June 2007, submission to 3G Americas.

Nortel: "4G Technology Comparison", June 2007, submission to 3G Americas.

Nortel: "Comparison on Performance Requirements," June 2008, submission to 3G Americas.

Nortel white paper: "GSM to LTE Evolution," June 2007.

Nortel: "Nortel's GSM/EDGE Radio Access Network (GERAN) Evolution," 2006.

Nortel: latency and spectral efficiency data, July 2006, submission to 3G Americas.

Joseph Palenchar: TWICE, April 10, 2007.

Research in Motion: "EDGE Evolution, GERAN Update," June 2006.

Portio Research: "Mobile Data Services Markets 2008", June 11, 2008.

Qualcomm: press release,
http://www.qualcomm.com/press/releases/2008/080207_Qualcomm_to_Ship.html.

Research in Motion: "Evolution of High Speed Wireless Data Standards in 3GPP", May 15, 2007.

Rysavy Research article: "Reach Me if You Can," <http://www.rysavy.com/papers.html>, May 2007.

Rysavy Research: "Hard Numbers and Experts' Insights on Migration to 4G Wireless Technology," published by Datacomm Research, February 2005.

Andy Seybold: "Will Data-Only Networks Ever Make Money?" January 18, 2006, commentary, <http://www.outlook4mobility.com/commentary2006/jan1806.htm>.

Chetan Sharma: "US Wireless Data Market Update - Q1 2008",
<http://www.chetansharma.com/usmarketupdateq108.htm>.

SNL Kagan: press release, "SNL Kagan Expects Wireless Data Revenue To Increase At A 16% Annual Rate Over The Next Decade", <http://www1.snl.com/press/20080731.asp>, July 31, 2008

Sprint: press release, January 30, 2007.

Sprint Nextel: Ali Tabassi, Fierce Wireless Webcast, "WiMAX: Mobilizing the Internet", March 5, 2008.

Telstra: presentation, "HSPA as an Open Eco-System Today – Telstra Next G Network", 2008.

Verizon Wireless: Verizon Broadband Access Web page, July 29, 2005.

Value Partners: "Getting the Most Out of the Digital Divide – Allocating UHF Spectrum to Maximise the Benefits for European Society", March 2008,
<http://www.spectrumstrategy.com/Pages/GB/perspectives/Spectrum-Getting-the-most-out-of-the-digital-dividend-2008.pdf>.

Wikipedia: http://en.wikipedia.org/wiki/World_population, July 2008.

Wireless Intelligence and AT Kearney: <http://www.cellular-news.com/story/31730.php?source=newsletter>, 2008.

Wireless Week: "One in Three Handsets Will Be a Smartphone by 2013",
<http://www.wirelessweek.com/article.aspx?id=158452>, March 2008.

This white paper was written for 3G Americas by Rysavy Research (<http://www.rysavy.com>) and utilized a composite of statistical information from multiple resources.

The contents of this paper reflect the research, analysis and conclusions of Rysavy Research and may not necessarily represent the comprehensive opinions and individual view points of each particular 3G Americas Board member company.

Rysavy Research provides this document and the information contained herein to you for informational purposes only. Rysavy Research provides this information solely on the basis that you will take responsibility for making your own assessments of the information.

Although Rysavy Research has exercised reasonable care in providing this information to you, Rysavy Research does not warrant that the information is error-free. Rysavy Research disclaims and in no event shall be liable for any losses or damages of any kind, whether direct, indirect, incidental, consequential, or punitive arising out of or in any way related to the use of the information.